

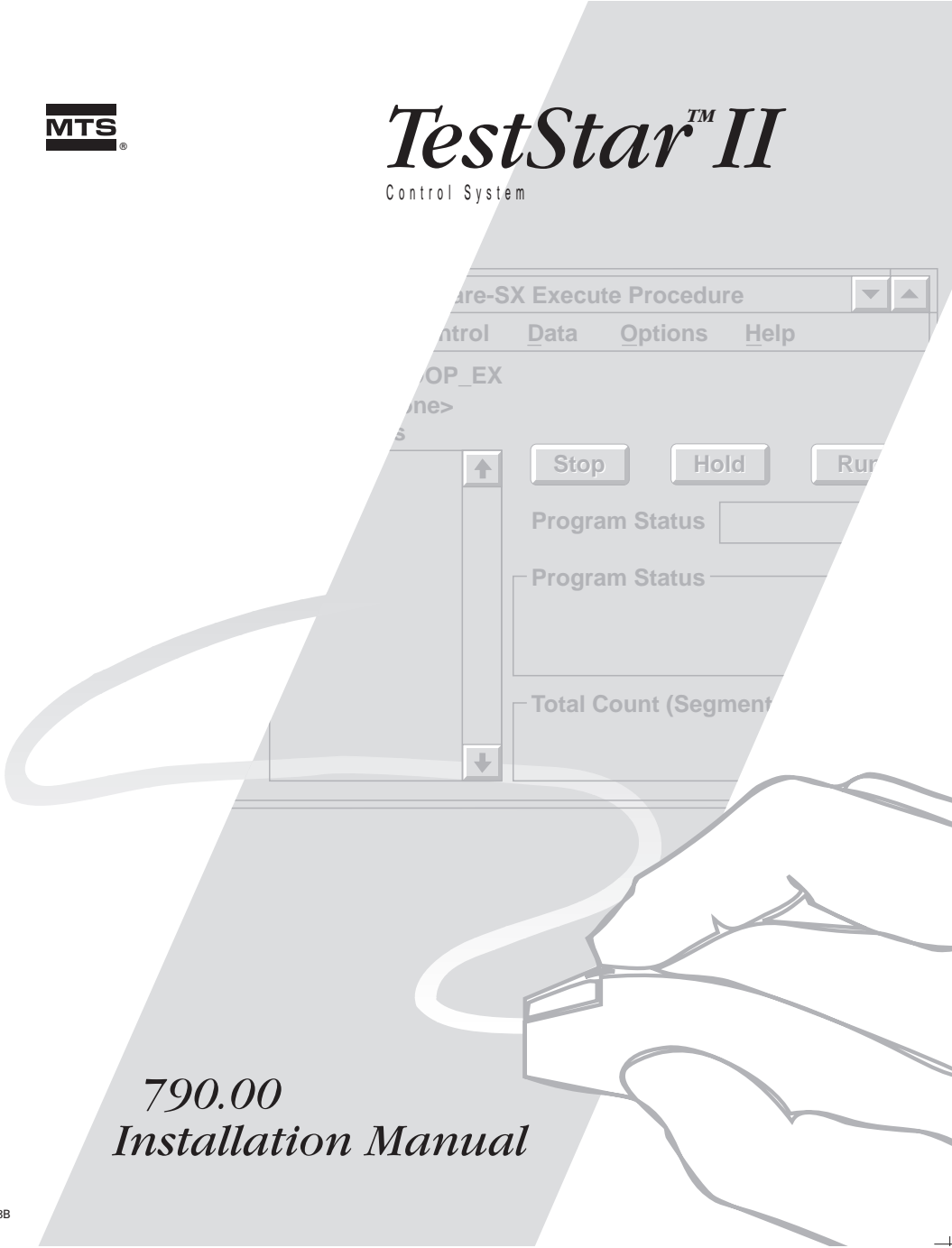

# TestStar™ II

Control System



*790.00  
Installation Manual*

**Proprietary data**

This manual, and the software it describes, are both copyrighted, with all rights reserved. Under the copyright laws, neither this manual nor the software may be copied, in whole or part, without written consent of MTS Systems Corporation, except in the normal use of the software or to make a backup copy of the software. The same proprietary and copyright notices must be affixed to any permitted copies as are made for others, whether or not sold, but all of the material purchased (with all backup copies) may be sold, given, or loaned to another person. Under the law, copying includes translating into another language or format. This software may be used on any computer, but extra copies cannot be made for that purpose.

---

**Copyright information**

© 1991-1997 MTS Systems Corporation. All Rights Reserved.

---

**Trademark information**

MTS is a registered trademark of MTS Systems Corporation. TestStar and TestWare-SX are trademarks of MTS Systems Corporation. IBM and OS/2 are registered trademarks of International Business Machines. Microsoft and Windows NT are registered trademarks of Microsoft Corporation.

---

**Publication information**

The following list the printed history of this manual.

<b>SOFTWARE RELEASE</b>	<b>MANUAL NUMBER</b>	<b>PUBLICATION DATE</b>
Release 1.1A	150200-01A	April 1991
Release 1.2A	150200-02A	September 1991
Release 1.3A	150200-02B	February 1992
Release 1.4A	150200-03A	July 1992
Release 2.0A	150200-04A	December 1993
Release 2.0B	150200-05A	April 1994
Release 3.0A	150200-06A	January 1995
Release 3.1A	150200-07A	September 1995
Release 3.1A	150200-07B	January 1996
Release 4.0A	150200-08A	October 1996
Release 4.0C	150200-08B	May 1997

# Table of Contents

---

## Preface 9

---

What's New with TestStar V 4.0	10
Other Manuals	11
Safety Precautions	12
General Safety Guidelines	13
Safety Guidelines to Follow While Operating the Equipment	16
Load Units and Other Crush Point Hazards	17
Avoiding Hazardous Actuator Movement	18
Guidelines For Installing Specimens	20
Checking the Hardware Setup	21
Installation and Modification Guidelines	22
Supervising the System	23
The Importance of Proper Maintenance	24
Hazard Conventions Used in This Manual	26
How to Obtain Technical Assistance	27
What to Expect When You Call	28

## Chapter 1      Installation Procedure 33

---

## Chapter 2 Hardware Installation 41

---

Section A: Installing the Digital Controller	42
Digital Controller Grounding	44
Digital Controller Power	45
Section B: Installing the Plug-in Modules	46
Module Locations	48
490.22 AC Conditioner Jumpers	50
490.21 DC Conditioner Jumpers	54
490.14/.17 Valve Driver Jumpers	59
490.60 Hydraulic I/O Jumpers	62
490.50 Processor Jumpers	64
490.70 Instrumentation Bus Controller Jumpers	65
Link/Processor Speed Jumpers	66
Section F: Special Hardware Packages	79
Model 380 Load Unit Interface Package	81
Model 490.17 Valve Driver Package	84
Model 448.16C Power Driver Package	87
Multiple HSM Channels	88
Forward Loop Filter Package	92
±15 Volt Power Package	95
ADT Support Package	98
115 Vac Solenoid Interface	100
Extended Analog I/O	104
Production QC	106

## Chapter 3    Cabling 113

---

Typical Cabling	115
Cable Assembly Numbers	116
CE Compliant Cabling	117
Rear Panel Connectors and Cabling	119
Panel 1 Connectors	120
J20 HSM Proportional	121
J24 HSM Auxiliary	122
J25 Hydraulic Power Supply	123
J28 HSM Solenoid	124
J29 Load Unit	125
J30 Emergency Stop	126
Panel 2 Connectors	127
J41A, J41B Readout	128
J42 External Data Inputs 1-8	129
J50 Load Unit Link	130
J51 Workstation Link	131
J63/J64 Extended Analog I/O	132
J71 through J80 BNC Connectors	133
Panel 3 Connectors	134
J23A, J23B Hyd Intlk 1 and 2	135
J43 Prgm Intlk	136
J44 Run Stop	137
J54 Digital Input	138
J55 Digital Output	140
J61 Aux I/O	142
Panel 4 Connectors	143
J1 - J10 Sensor Connections	144
J11 - J14 Sensor/Servo Valve Connections	146
J15, J16 Sensor Monitor Connections	148
Auxiliary I/O Panel	150

## Chapter 4      Software Installation 155

---

- Installing TestStar V3.1C 156
  - Abbreviated Procedure 159
- Moving TestStar V3.1 Files to TestStar V 4.0 180
  - Using the Upgrade Assistant Program 181
- Installing TestStar V4.0 182
  - Abbreviated Procedure 184

## Chapter 5      Initial Software Settings 201

---

- Abbreviated Procedure 203

## Chapter 6      LVDT Calibration 225

---

- Abbreviated Procedure 227

## **Chapter 7      Force Calibration 257**

---

Abbreviated Procedure 259

## **Chapter 8      Extensometer Calibration 289**

---

Abbreviated Procedure 291

## **Chapter 9      Sensor Calibration Data 321**

---

Section A: Printing Calibration Data 323

Section B: Backing Up Calibration Data 327

Section C: Retrieving Calibration Data 331

## **Chapter 10     External Signals 337**

---

Abbreviated Procedure 341

## Appendix 358

---

Hardware Specifications	359
Model 490.01 Chassis Power Supply Module	360
Model 490.14/.17 Valve Driver Modules	361
Model 490.21 DC Conditioner Module	362
Model 490.22 AC Conditioner Module	364
Model 490.30 Workstation Communication Interface	366
Model 490.40 Analog I/O Module	367
Model 490.50 Processor Module	368
Model 490.60 Hydraulic I/O Module	369
Servo Valve Adjustments	370
Initial Inner Loop Adjustments	372
Adjusting Valve Balance	383
Adjusting Dither Amplitude	385
Adjusting Inner Loop Gain and Rate	387
System Calibration Program	391
Diagnostics Program	394
WSCI Diagnostics	398
Load Unit Interface	399
Interlock Diagnostic Program	402
Strain Gage Calibration	405
How Bridge Completion Works	406
Strain Gage Calibration Procedure	407
Strain Gage Reference Information	411

## Index 415

---



# Preface

---

## What this manual does

This manual provides detailed information about installing the TestStar system. This includes the TestStar hardware, software, and initial software settings. This manual also includes specialized information to calibrate sensors, use external signals, and install optional hardware packages. This chapter describes a sequence to install TestStar.

This manual supports TestStar software versions 3.1 and 4.0.

---

## What this manual does not do

This manual does not provide detailed information about other system components such as hydraulic components and sensors. Go to each product manual for installation procedures. This manual does not provide detailed operating instructions to run a test. It is your responsibility to ensure that all test methods you use are accurate and safe.

---

## What you need to know

TestStar is available for both IBM OS/2 and Microsoft Windows NT operating systems. You need to have a reasonable knowledge of your operating system before attempting to use this manual. You should know how to open and close windows, manage files, and so on.

- ◆ TestStar Version 3.1 use Operating System/2™ (OS/2®), Warp 3.0.
  - ◆ TestStar Version 4.0 and newer use Microsoft® Windows NT®.
- 

## Who should use this manual

This manual is designed for individuals whose duties require knowledge of the TestStar hardware such as installing the equipment or changing the hardware configuration. This manual is also designed for individuals whose duties require knowledge of the TestStar software such as assigning new users.

---

# What's New with TestStar V 4.0

---

- ◆ TestStar V4.0 is functionally the same as TestStar V3.1. The difference is that TestStar V4.0 requires the Microsoft® Windows NT® operating system.
  - ◆ With the change in operating systems, the Kanji language is not supported in TestStar V4.0.
-

# Other Manuals

---

This manual is part of a set of TestStar manuals that describe TestStar (which is a part of a complete testing system). The following describe the TestStar and MTS system manuals and “integrated” training package.

- ◆ The **Reference Manual** (p/n 150194-xxx) describes every menu selection and how things work in every window for the TestStar application and all of the utility programs.
  - ◆ The **TestWare®-SX Application Manual** (p/n 150197-xxx) describes a general purpose application for TestStar. This includes function generation, data acquisition, event detection, and external control features.
  - ◆ The optional **C Programming Reference Manual** (p/n 150195-xxx) describes how to interface with TestStar using a high-level programming language.
  - ◆ The **Product Information Manual** contains tabbed sections that describe the hardware components included with your system, such as your load unit and grips. This manual is primarily about hydromechanical products.
  - ◆ The **Assembly Drawings Manual** contains tabbed sections that contain engineering drawings and part lists of many of the hardware components covered in the Product Information manual. This manual helps you to service your equipment and is useful for MTS Service Engineers if they service your equipment.
  - ◆ The optional **TestStar A to Z** manual (p/n 150371-xxx) is an encyclopedia of testing. It describes testing terminology, concepts, and topics—from Actuators to Zeroing sensors.
  - ◆ You may also have other manuals for components included with your system that are not manufactured by MTS, such as a printer manual or video monitor manual.
-

# Safety Precautions

---

## WARNING

**Improper system installation, operation, or maintenance can result in hazardous conditions that can cause severe personal injury or death, and damage to equipment or specimen.**

Read these Safety Precautions before you use the equipment.

It is very important that you remain aware of hazards that apply to your test system. These Safety Precautions describe hazards that apply to your test system, and offer suggestions for avoiding hazards.

---

## Overview

This chapter contains general operating safety techniques and precautions for operators of materials test systems.

Because each test system is configured for a unique application and operates within a unique environment, it is important to review these guidelines while considering your test system to ensure that the specific operating environment and operating procedures do not result in hazardous situations. Although complete elimination of hazards may not be possible, use the following guidelines to identify hazards so that appropriate training, operating procedures, and safety equipment can be set up.

Common sense and a thorough knowledge of a specific system's operation and capabilities usually suggest the appropriate approach to system operation safety. Therefore, proper safety practices should begin with operator training. Operators should have had prior schooling and training on similar systems. (MTS has training classes that cover servo hydraulic operating theory, system operating procedures, and system maintenance techniques.) In addition, you should gain an understanding of system functions by studying the various instructions and manuals supplied with the test system.

---

## General Safety Guidelines

---

The following safety guidelines are applicable to most test systems. As you read each item listed below, consider how it applies to your system. This can help to produce safer operating practices. If you have any questions, contact an MTS representative.

### Know safety placards, read the manuals

Locate, read, and follow all instructions on equipment safety placards. Placard location is typically described in the installation section of the hydro mechanical product manuals.

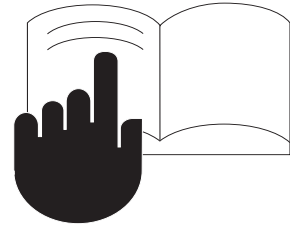

### Know emergency stops

Know where all of the system **Emergency Stop** buttons are located so that you can stop the system quickly. **Emergency Stop** buttons have striping like the sample shown at the right.



### Know potential crush points

Know where the potential load unit pinch and crush points are and take appropriate safety precautions. Refer to the discussion on crush point hazards.



### Know system interlocks

System interlock devices should always be used and properly adjusted as described in this manual. Test all interlock devices for proper operation immediately before a test. Never rely on interlock devices to protect you. These devices are designed to minimize the chances of accidental damage to test specimens or to equipment.

**Do not bypass the interlock chain**

Do not use any interlock reset to bypass the interlock chain while attempting to start the hydraulic power supply. Doing this could cause the hydraulic pressure to be applied regardless of the interlock condition.

**Do not disturb sensors**

Do not bump, wiggle, adjust, disconnect, or otherwise disturb a sensor (e.g., an extensometer) when hydraulic pressure is applied and the system is operating under control from that sensor.

**Ensure secure cable connections**

Do not change any cable connections with electrical power or hydraulic pressure applied. Changing cable connections with the system operating can result in an open control loop condition. An open control loop condition can cause rapid unexpected system response resulting in severe personal injury or death or damage to equipment. Also ensure all cables are connected if you make any changes in the system configuration.

**Stay Alert**

Avoid long periods of unvarying or monotonous work tasks that can contribute to accidents and hazardous situations. Familiarity with the working environment can lead you to overlook potential hazards in that environment.

**Stay clear of moving equipment**

Keep clear of moving mechanical linkages. Also stay clear of connecting cables and hoses that move along with the specimen or equipment. Objects may get tangled or dragged along with moving equipment. Serious injury can be inflicted by very high forces that can be produced. These forces could pinch, cut, or crush anything in the path of the moving equipment.

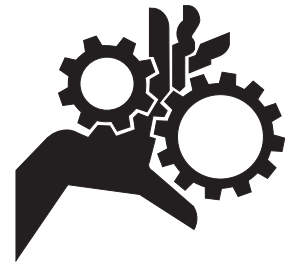

**Be aware of electrical hazards**

To minimize potential electrical shock hazards while the system electrical power is turned on, avoid touching exposed wiring or switch contacts.



**Use eye protection**

Use adequate eye protection when working with high-pressure hydraulic fluid or explosive specimens, and in circumstances during which anything peculiar to the specimen setup could break apart and cause eye injury.

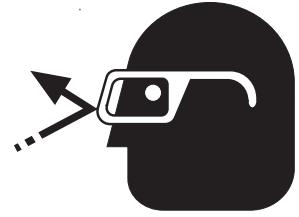
**Have first aid available**

Accidents happen even to careful people. Arrange scheduling so that a properly trained person will be close by at all times to render first aid.

**Practice good housekeeping**

Keep work area floors clean. Hydraulic fluid spilled on any type of flooring results in a dangerous, slippery surface.

**Keep bystanders away**

Keep bystanders at a safe distance from all equipment. Never allow bystanders to touch specimens or equipment while the test is running.

**Wear proper clothing**

Do not wear neckties, shop aprons, loose clothing, or long hair that could get caught in equipment and create a potentially injurious situation.

---

## Safety Guidelines to Follow While Operating the Equipment

---

### Know proper system operation

Do not make mechanical or electrical adjustments to system components unless you know exactly how the adjustment will affect system operation. Consult your MTS representative when in doubt about any adjustment procedure.

### Know results of using system controls

Do not make any unnecessary adjustments during operation of the system. To avoid erratic or unexpected system response, do not make any adjustments while the system is operating unless specifically instructed to do so.

### Know crosshead lift and lock controls

Unlock the crosshead only with high hydraulic pressure applied. Do not adjust the lift controls when the crosshead is locked.

### Know when to turn on hydraulics

Turn off hydraulic power except for those times that it is necessary for specimen setup or to run the test. Do not have hydraulic power on when making changes to the system configuration.

### Know system control electronics

Have a thorough knowledge of the control electronics before turning on hydraulic power. Always follow the recommended operational procedures to turn on hydraulic power—failure to do so can cause the actuator to move rapidly and unexpectedly.

### Know system hydraulic configuration

Some test sites have multiple test stations served by one hydraulic power supply. Understand how these units are interconnected before turning on hydraulic power.

### Check system cabling

Check the cabling to the system sensors and servovalve. If the feedback or servovalve signal is lost for any reason (such as the connector coming loose or not connected, or the cable is damaged), the resulting signal loss will cause the actuator piston to move at maximum force and maximum velocity until it reaches a mechanical limit. Anything in its path (including you) could be crushed.

### Make a trial run

Before operating the system for the first time, make a trial run through the desired test by locating the window controls involved without actually performing the adjustment or turning on hydraulic power.



## Load Units and Other Crush Point Hazards

---

It is especially important to stay clear of any potential crush points when the system is operating. Know where the crush points are in your system and protect yourself and others from those crush points with appropriate safety devices. The following paragraphs describe crush points and precautions to take while working around crush points. These paragraphs apply to most testing and production systems.

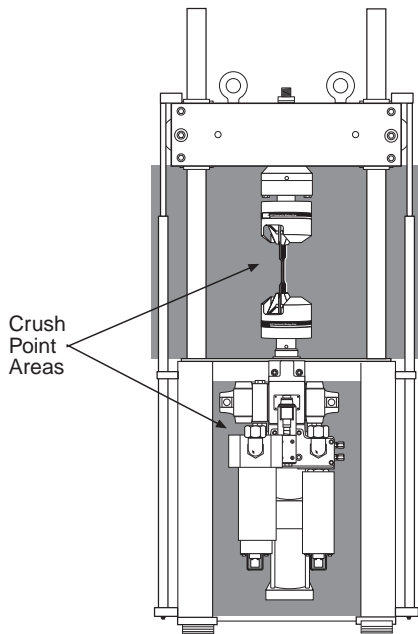

- ◆ Keep clear of any mechanical linkage that moves within a closed area. If the linkage should move (when the system starts or due to mechanical failure), very high forces can be present that could pinch, cut, or crush anything in the path of linkage movement.
- ◆ Never allow any part of your body to enter the path of machine movement or to touch moving machinery, linkages, hoses, cables, specimens, etc. These present serious crush points or pinch points.
- ◆ A crush point exists between the platen and crosshead on load units where the actuator piston rod and specimen move. Another potential crush point exists where the lower end of the actuator piston rod extends below the platen and the bottom of the load unit/load frame.

## Avoiding Hazardous Actuator Movement

---

The high forces and rapid motions that are usually present in testing systems can produce destructive forces from unexpected or uncontrolled actuator response.

### CAUTION

#### Several things can cause unexpected actuator movement.

The possible combinations of system hardware and software settings make it impossible to predict conditions that produce unexpected actuator movement.

Some conditions can cause an actuator to slam to its mechanical limit, smashing anything in its path. Some conditions can cause an actuator to react so slowly to a command it may appear not to be working. And some conditions can cause the actuator dance in an unstable fashion while making an obnoxious noise.

Following are safety precautions for you to take:

- ◆ If the control mode feedback signal is interrupted during operation (e.g., if a sensor or servovalve cable is disconnected or breaks), the digital controller senses an error and causes the actuator to attempt to correct the error by stroking at maximum force and maximum velocity until it reaches an internal limit or external mechanical obstruction (e.g., tools, specimens, hands). The full force of the actuator will be applied to that limit or obstruction. (A selectable operating range does not reduce the force capability, it only increases the sensitivity of the electronic components.) To avoid a control mode feedback signal loss, protect sensor cables from damage, and never connect or disconnect any cable with electric of hydraulic pressure applied. If the feedback signal is lost, remove hydraulic pressure immediately. An open control loop also results if the cable from the digital controller to the servovalve is disconnected or broken while hydraulic pressure is applied.
- ◆ The composite command signal for the servo control loop may consist of several program inputs. If one of these inputs is suddenly changed while hydraulic pressure is applied, the servo control loop will sense a large instantaneous error and the actuator will respond accordingly. Do not make any program changes unless you know exactly how the change will affect operation.

- ◆ An unexpected actuator stroke or excessive actuator force can result from over programming. The composite command to the servo control loop is the algebraic sum of the Function Generator window's **Mean Level** and **Amplitude** inputs; either can program  $\pm 100\%$  of the system's force-producing capability. For example, in most systems, a  $\pm 10$  volt signal produces full system response: if the input to the controller is a  $\pm 10$ -volt sine wave and **Amplitude** is adjusted to the maximum setting, any mean level offset introduced by the **Amplitude** control causes the command to exceed the capabilities of the system. When determining program commands, make sure to avoid over programming.
  - ◆ Many systems contain hydraulic accumulators that store enough energy to temporarily operate the actuator at full force capacity when the hydraulic pressure is shut off. For this reason, the usual interlock devices will not prevent hazardous actuator stroking.
  - ◆ The failure or shutoff of electrical power to the testing system while hydraulic pressure is applied will cause considerable, unpredictable actuator reaction due to stored energy in the accumulators and irregular pump shutdown. Under these conditions, the actuator will generally stroke at maximum force and maximum velocity in either direction or, if a specimen is attached, apply full tensile or compressive force (i.e., positive or negative acceleration). Ensure that electrical power connections are not interrupted during test system operation.
  - ◆ Do not use any interlock reset to bypass the interlock chain and attempt to start the hydraulic power supply. Doing this will cause the hydraulic power supply to start and hydraulic pressure will be applied regardless of the interlock condition. The error detector may be adjusted to trip whenever a large error is present, preventing the continued application of hydraulic pressure.
-

## Guidelines For Installing Specimens

---

Because you are very close to or in contact with the system force train during specimen installation, this procedure can be the most hazardous part of system operation. Because it is usually necessary to have hydraulic power turned on, follow all of the instructions in this manual in addition to the following:

- ◆ Clear the work area, especially near system crush points.
  - ◆ Ensure that the servo control loop is properly phased and stable (refer to the TestStar Installation Manual for procedures). Be particularly alert for phase or control reversal if the system setup has been modified since the previous operation. If operating the system in force or strain control, adjust the gain control to a value known by experience to be stable for the particular specimen in use.
  - ◆ Use extreme caution when handling or supporting the specimen so that fingers and hands are never exposed to potential crush points during specimen installation. Use tongs to handle the specimen.
  - ◆ To move the crosshead on load units not equipped with hydraulic lifts, support the crosshead using a lifting device capable of supporting the crosshead weight plus the weight of any fixtures and grips. Remove any slack from the crane cable or chain before unlocking the crosshead.
  - ◆ A hazardous situation exists when air becomes trapped inside the lift cylinders on load units equipped with hydraulic lifts. Trapped air can cause erratic movement of the crosshead when the lift controls are operated. After installation, or if the crosshead does not move smoothly, bleed the lift cylinders as directed in the load unit product manual. Stay clear of the lower platen and the crosshead when operating the lift controls.
-

## Checking the Hardware Setup

---

Always determine the necessary hardware configuration required for the test to be performed. Make all necessary changes to the configuration before applying electrical power or hydraulic pressure.

---

### Check for hardware configuration changes

Due to the comprehensive nature of the system's testing capabilities, different types of tests may require changes in the hardware configuration to accommodate specific desired test results. Examples of hardware configuration changes include:

- ◆ Changing from one extensometer to another.
  - ◆ Changing from a high-capacity force sensor to a low-capacity force sensor.
  - ◆ Changing the sensor cartridge for higher or lower resolution testing.
  - ◆ Changing between servovalves on dual servovalve manifolds.
- 

### When you have multiple force sensors

If the system is configured to use more than one force sensor (e.g., typically, one with a force rating equal to system capability and another with a lower force rating), additional considerations may be necessary to protect the low capacity force sensor from damage. Using a force sensor rated below the maximum capability of the system is basically the same as changing a sensor cartridge. It does not reduce the full force capability of the hydraulic actuator. It only increases the sensitivity of the electronic control and readout components.

---

## Installation and Modification Guidelines

---

The following installation and modification guidelines recommend design practices and modified system setup considerations that should be observed to minimize system operating hazards. Even when using the system for the first time and setup changes seem unlikely, a thorough understanding of the following guidelines will help in understanding system operation:

- ◆ Tests often operate for extended periods with no supervision and may attract spectators. This combination requires that any test laboratory setup provide adequate protection for bystanders as well as for system operators.
  - ◆ Be sure to study the manuals to gain sufficient knowledge of system operation, and service and modification procedures.
  - ◆ Refer to the TestStar Installation Manual for information about emergency stop connections on the digital controller rear panel.
  - ◆ A competent engineer should be responsible for system installation or modification. The engineer must consider how changes to an existing facility or system might affect safety and reliability.
-

## Supervising the System

---

The engineer responsible for any installation, modification or alteration to a test system should consider the following precautions:

- ◆ Protect all system hoses and cables from sharp or abrasive objects that could cause hose or cable failure. Route hoses and cables away from areas that expose them to possible damage.
  - ◆ To avoid thrashing and subsequent deterioration, hydraulic pressure hoses should be anchored to the ground or tied to a corresponding return line within two feet of the flow outlet end. As an alternative, hoses can be run in trenches or other protected areas. Design enough fittings into a system to allow for the accommodation of dimensional errors without placing severe strains on the fittings or tube ends. Be sure to use appropriately rated fittings from a reputable manufacturer. Pressure line hoses for normal hydraulic service should have a burst pressure at least four times the operating pressure.
  - ◆ Ensure all operators are familiar with any changes to the test system and provide training on how the changes affect operation and maintenance.
-

## The Importance of Proper Maintenance

---

Proper maintenance is important to system operating safety. Without good maintenance practices, system reliability and safety degrades to the point where potential hazards can become extreme dangers. Study the manuals and the following paragraphs before beginning any type of system maintenance.

- ◆ Service must be done only by qualified persons.
- ◆ The service procedures in the individual product manuals are effective ways of maintaining the units. Read the procedures before you start working on a unit, then follow them carefully. In other words, don't get inventive.
- ◆ Use only designated MTS replacement parts. Parts not approved by MTS can adversely affect safety in addition to degrading reliability, increasing maintenance downtime, and voiding warranty coverage.
- ◆ Perform all calibration procedures in the TestStar Installation Manual to avoid improper signal scaling. Electronic signals between system components interact to operate the entire system.
- ◆ Systems that use pneumatic devices (e.g., accumulators, certain tandem and high-rate actuators) contain high-pressure gas that is very hazardous if improperly handled or poorly maintained. Read all gas cylinder labels to properly identify the type of accumulator and the type of gas used.
- ◆ Follow all accumulator charging instructions given in the manuals. When charging accumulators, use only dry nitrogen. (Dry nitrogen can be labeled "oil pumped" or "dry water pumped.") Do not use oxygen in place of nitrogen. If oxygen comes in contact with hydraulic fluid (e.g., if an accumulator bladder ruptures or leaks), a highly explosive condition will exist. When in doubt about any nitrogen charging procedure or about any type of accumulator, consult MTS Systems Corporation (refer to the Preface for information on technical assistance).
- ◆ Protect electrical cables from spilled hydraulic fluid and excessive temperatures that can cause cable hardening and can eventually result in cable failure. Clean spilled hydraulic fluid from cables as soon as possible.



- ◆ Inspect all cables for cuts, exposed wires, or other types of possible damage prior to system operation. Cable connectors must be securely plugged into their respective receptacles. Inspect each cable where it enters the cable connector for signs of excessive flexing (broken insulation) or exposed wires.
  - ◆ Remove all system power before replacing any cable found to be defective. Ensure that all cables have appropriate strain relief devices installed at the cable and near the connector plug. Do not use the connector plug as a strain relief.
  - ◆ Thoroughly inspect hoses for blisters, cuts, or other damage prior to system operation. Any weakening of the wire wrapping or reinforcing should be considered cause for hose replacement. While the system is operating, inspect all hoses and cables to ensure that there is no excessive thrashing, bending, or chafing that could cause cable or hose damage.
  - ◆ Flush the hydraulic system immediately after any of the system's piping (i.e., hoses, hard lines, servovalve, hydraulic power supply components, etc.) has been replaced or its configuration has changed.
  - ◆ Special safety considerations are necessary when operating a system that contains fire-resistant hydraulic fluid. These fluids are usually toxic and can present a lethal situation if fluid is accidentally swallowed or if a sufficient amount of fluid is absorbed through the skin. Avoid breathing the vapor or mist from these fluids, do not eat or smoke while working with these fluids, and practice absolute personal cleanliness when working with these fluids. Do not mix fire-resistant fluids with petroleum-based fluids. Also, do not add fire-resistant fluids to systems incompatible with these types of fluids (doing so will destroy seals and severely damage the equipment).
-

## Hazard Conventions Used in This Manual

---

The following techniques are used to highlight special types of information.

### WARNING

---

**Warnings alert you that something hazardous can occur if you do not follow the instructions carefully. Physical injury to you or to the machine (or both) will likely be severe.**

The plain (unbolded) text below the initial bolded sentence gives you additional instructions about how to avoid the hazard.

---

### CAUTION

---

**Cautions alert you that something hazardous can occur if you do not follow the instructions carefully. However, the personal injury or equipment damage will likely be moderate.**

Cautions are also used for procedures that can cause loss or corruption of computer programs or data.

---

### NOTE

Notes are used to point out especially important information that you should know before performing an operation, but failure to do so is not likely to result in a hazard.

---

### Boldface text

---

Boldface terms such as **Emergency Stop** are direct references to physical control and indicator labels on the test system.

---

# How to Obtain Technical Assistance

---

If you have any questions about an MTS system or product, contact the MTS corporate service center.

**Note** Review the following pages for information about what to expect when you contact us.

## Address

MTS Systems Corporation  
Service Support Group  
Technical Support Department  
14000 Technology Drive  
Eden Prairie, Minnesota 55344-2290

---

## Telephone

In the United States (all 50 states) HELPLine (800) 328-2255

Outside U.S. Contact your local service center

---

## Telex

29-0521

---

## Fax

Technical support questions (612) 937-4766

General questions (612) 937-4515

---

## Internet

E-mail [Info@mts.com](mailto:Info@mts.com)

Home Page <http://www.mts.com>

---

## What to Expect When You Call

---

Your call will be registered by a HELPLine agent. The agent will ask for your site number. If you do not have an MTS site number or do not know your site number, you should contact your MTS sales engineer.

**The HELPLine agent may also ask to verify the following information:**

- ◆ Your company's name
- ◆ Your company's address
- ◆ Your name and the telephone number where you can normally be reached.

**If you have called before regarding this problem, we can recall your file. You'll need to tell us the following:**

- ◆ The MTS work order number.
- ◆ The name of the person who helped you.
- ◆ Be prepared to respond to questions when interfacing with MTS technical support personnel. We may ask you to perform certain tasks so we can locate the source of the problem.

### Before you call

Prepare the following information before you call HELPLine support to prepare for the troubleshooting process.

**Know your site number and system number.**

**Describe the problem you are experiencing:**

- ◆ How long has the problem been occurring?
- ◆ Can you reproduce the problem?
- ◆ Were any hardware changes made to the application or system operating software before the problem started?

**Have the following information available:**

- ◆ If relevant, print-outs of configuration files, and test procedures.
- ◆ The type or model number of your test frame, load unit, etc.
- ◆ The type of model number of your controller

- ◆ Model number and size of your hydraulic service manifold
- ◆ Serial number of any suspect component

**If you are experiencing a computer problem, please have the following information available:**

- ◆ Manufacturer's name
- ◆ Manufacturer's model number
- ◆ Type of system memory
- ◆ Amount of system memory
- ◆ Floppy drive information (model number, size, and capacity)
- ◆ Hard drive information (model number, size, and capacity)
- ◆ Manufacturer of printer/plotter and model number
- ◆ Mouse information (bus, serial; connected to what port?)
- ◆ Graphics board information (manufacturer and model)
- ◆ What other boards are installed in the computer?
- ◆ Is the system part of a network?

**If you are experiencing a software problem, please have the following information available:**

- ◆ Operating software information
  - What type of operational software are you running?
  - What version level of operating system is running?
  - What window type is used?
- ◆ Application software information:
  - What applications are you running? (MultiPurpose TestWare, etc.)
  - Know the version of each software application involved.

**Other software being used:**

- ◆ What other software was running when the problem was encountered? This could include such things as screen savers, keyboard enhancers, print spoolers, etc.
- ◆ Know the name and version of each software program involved.

## While on the phone

### **Prepare yourself for troubleshooting while on the phone:**

- ◆ Try to call from a telephone close to the system so that you can conduct some active testing over the phone.
- ◆ Have the original operating and application software disks available.
- ◆ If you are not familiar with all aspects of the operation of the equipment, have the necessary people available to assist you.

### **Prepare yourself in case a call back is required:**

- ◆ Remember to ask for the work order number.
- ◆ Record the name of the person who helped you.
- ◆ Make sure you are able to write down any specific instructions to be followed, such as data recording or performance monitoring.



# TestStar™ II

Control System

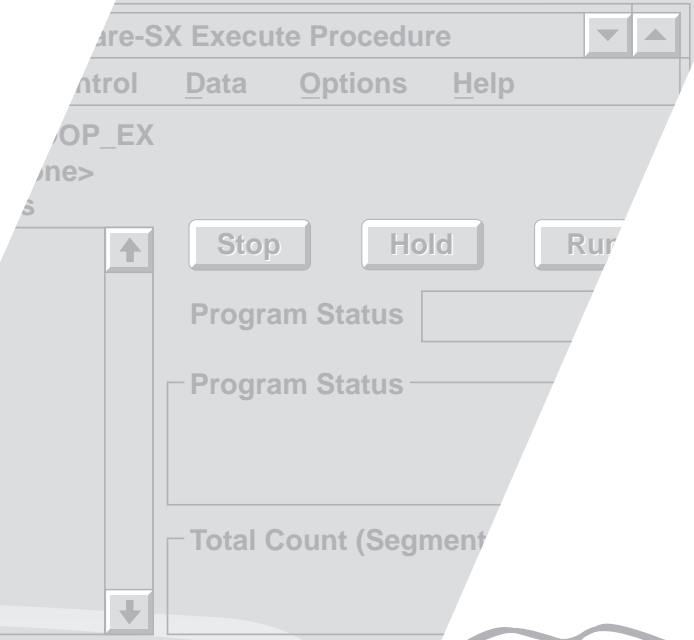

## *Chapter 1 Installation Instructions*

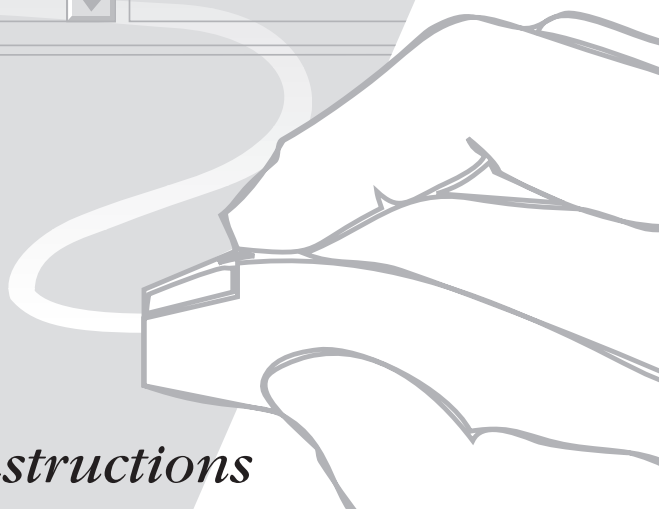

 **WARNING**

**Read the Safety Precautions in the Preface before you use the equipment.**

The Safety Precautions portion describes hazards that apply to test systems and offers suggestions for avoiding hazards.

MTS test systems are powered by high-pressure hydraulic fluid. High-pressure hydraulic fluid is potentially dangerous. It is very important that you remain aware of hazards that apply to a test system.

---



## Chapter 1

# Installation Procedure

---

The information in this manual is arranged in the order you would typically install TestStar. The following procedure guides you through the chapters in this manual.

### Procedure

1. Install the TestStar hardware 34
2. Connect the appropriate cables 34
3. Install the system software 35
4. Establish the initial software settings 35
5. Check the servovalve polarity 36
6. Calibrate the sensors 37
7. Back up the sensor data base 38
8. Create a TestStar configuration file 38

### Prerequisite

The hydraulic equipment for your test system should be installed before installing TestStar. Cable connections to the hydraulic equipment are described in this manual. See the appropriate product manuals to install the hydraulic equipment.

### How to use this procedure

Each TestStar system has different installation requirements. Use this procedure to guide you through the entire manual. Only perform those procedures that apply to your system.

Some systems may have been installed by qualified personnel and you may want to change some aspect of your system. Use this procedure (or the index) to determine where appropriate information may be found. You can also use this procedure to determine how your system is setup.

## Step 1 Install the TestStar hardware

Go to Chapter 2, *Hardware Installation* on page 41 and complete the following:

- ◆ Install the digital controller. Section A (*page 42*) describes how the digital controller can be installed in a console or as a floor-standing unit.
  - ◆ Install the plug-in modules. Section B (*page 46*) describes how some modules have required locations while conditioners and valve drivers have installation guidelines.
  - ◆ Section C (*page 69*) describes how to install the workstation communications interface circuit card into the host computer.
  - ◆ Section D (*page 73*) describes how to install the load unit control panel. The LUCP can be mounted to the load unit or on a free-standing pedestal.
  - ◆ Section E (*page 75*) describes how to set up the sensor cartridges with shunt calibration and bridge completion resistors for the dc conditioners.
  - ◆ Section F (*page 79*) describe the installation of several optional hardware packages.
- 

## Step 2 Connect the appropriate cables

Go to Chapter 3, *Cabling* on page 113 and determine which cables should be connected to your system.

- ◆ Review the typical cabling figure to determine which components you need to connect.
  - ◆ Review the cable assembly numbers table to determine which cables you have and which cables you may need to fabricate.
  - ◆ Also review the table for jumper plugs; any connector specifying a jumper plug is a required connection. Any required connector that does not have a cable assembly requires a jumper plug.
  - ◆ Be sure to identify the module location of each conditioner and its associated sensor.
-

### Step 3 Install the system software

Go to Chapter 4, *Software Installation* on page 155 and install the TestStar system software.

- ◆ Installing the system software for the first time. This is for the initial installation or if you reformatted your hard drive.
- ◆ If you are updating TestStar from version 3.1, see *Moving TestStar V3.1 Files to TestStar V 4.0* on page 180 for information about the files you may want to backup.

The following modes of operation are available after TestStar has been installed.

- ◆ Defining software parameters. Use this operation mode to change the language that TestStar uses.
  - ◆ Reconfiguring the system hardware. Use this operation mode to change hardware configuration of TestStar. This defines primarily hydraulic equipment, but it can also set up an RS-232 serial interface with a Series 409 Temperature Controller. It can also define your system as electro-mechanical or servo-hydraulic system.
- 

### Step 4 Establish the initial software settings

Go to Chapter 5, *Initial Software Settings* on page 201 and establish the initial software settings. This includes:

- ◆ Defining input signals from sensors (transducers).
  - ◆ Defining control channels and control modes. Each actuator requires a control channel and at least one control mode.
  - ◆ Defining output signals if you intend to calibrate sensors or tune the control modes.
  - ◆ Defining user names and their access to TestStar applications.
  - ◆ Defining the load unit control panel display
- 

**Note** *The remaining steps require that the hydraulic components of the system are installed.*

## Step 5 Check the servovalve polarity

The polarity of the servovalve must be checked before sensor calibration begins.

- A Disconnect the force sensor cable.
- B Select a control mode that uses the force sensors feedback signal and the actuator positioning control on the load unit control panel (Pod).

Use the list icon in the main TestStar window to select the appropriate control mode.

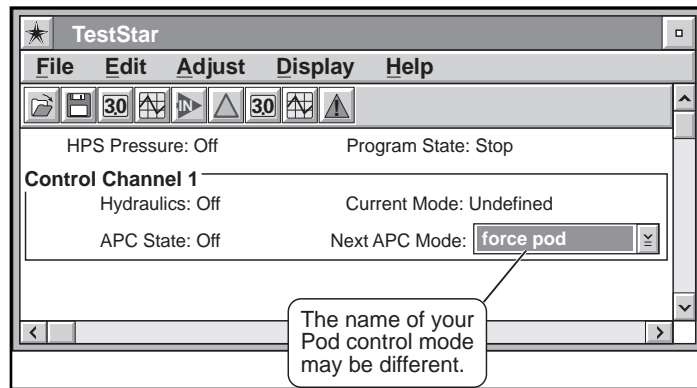

- C Press the Actuator Positioning Control switch on the load unit control panel to light the indicator (enabling the positioning control).
- D Press the HPS Control Low switch to apply low hydraulic pressure to the system.
- E Press the HSM Control Low switch to apply low hydraulic pressure to the actuator.
- F Adjust the Actuator Positioning Control clockwise.
  - ◆ If the actuator retracts, the servovalve polarity is correct.
  - ◆ If the actuator extends, the servovalve polarity must be reversed. Select Drive in the Adjust menu. Press the Setup pushbutton and change the polarity setting.
- G Reconnect the force sensor cable.

### NOTE:

These conditions assume you want a positive command to retract the actuator.

## Step 6 Calibrate the sensors

Determine which sensors to calibrate and go to the appropriate chapter.

- ◆ Go to Chapter 6 ([page 225](#)) to calibrate an LVDT
- ◆ Go to Chapter 7 ([page 257](#)) to calibrate the force sensor
- ◆ Go to Chapter 8 ([page 289](#)) to calibrate an extensometer

If you purchased a calibrated sensor from MTS Systems Corporation, the calibration data may have been installed during the software installation program. If not, go to Chapter 9 to import the sensor calibration data.

If you are using a sensor connected to another control system or an command signal from an external device, go to Chapter 10 to define the external signal information.

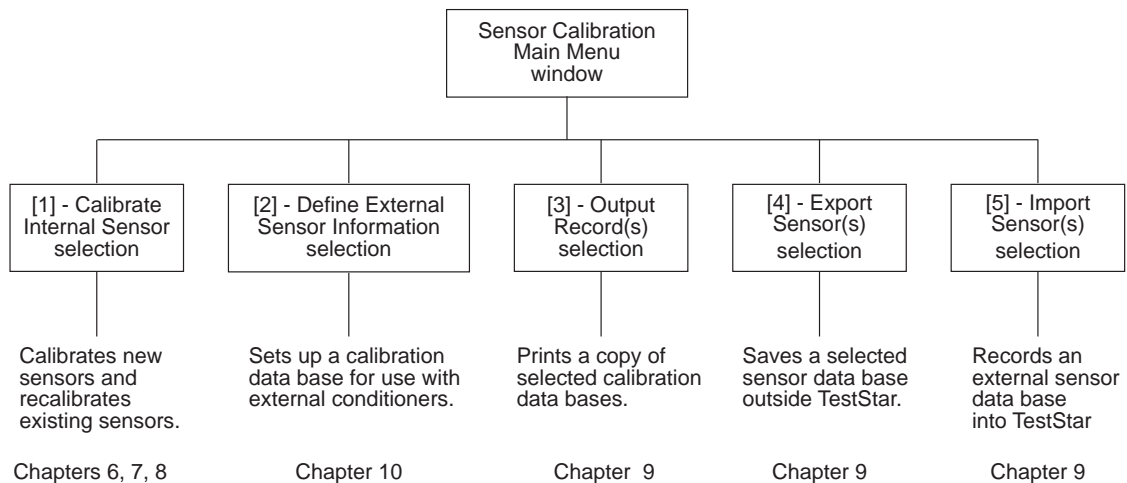

The Sensor Calibration program has five functions that generate or manage the sensor calibration data files.

## Step 7 Back up the sensor data base

Go to Chapter 9, *Sensor Calibration Data* on page 321 and follow the procedure Backing up Calibration Data. Chapter 9 also provides information to restore calibration data and how to acquire an ASCII file of the calibration data records.

---

## Step 8 Create a TestStar configuration file

A TestStar configuration file contains information about every selection you made in every TestStar window. Each type of test you use should have a different configuration file. The configuration file not only saves every TestStar parameter setting, it also includes the size and screen location of every TestStar window.

### Initial configuration file

The initial TestStar configuration file (default.TCC) that was saved when you established the initial software settings (Chapter 5) is not ready to run any test. The default.TCC file defines a few parameters related to the hardware connected to your system. See the Basic guidelines to establish a configuration file that is appropriate for a test.

### Creating a new configuration file

The easiest way to create a new configuration file is to open an existing file that is similar to the one you will create and save it with a different filename. Even when you use another file, you need to verify all of the settings and change those that are unique to the new configuration.

### Basic guidelines

The basic guideline to create a TestStar configuration file is to start with the Edit menu and Input Signals selection. Either define a new input or check each defined input signal definition to be sure it is appropriate for the test. Change or remove any setting or parameter that is not needed. Then move onto the next Edit menu selection and check all the window information. Continue through the Edit menu choices, then go through the Adjust menu and finally Display menu. When you have set all the window parameters, use the File menu to save the configuration.

**Note** *TestStar configuration files are saved to the (default) location C:\TS2\config or the selection of Step 4, Task 3, Chapter 4. If you want to backup your TestStar configuration files, copy them from that directory location.*

---



# *TestStar™ II*

Control System

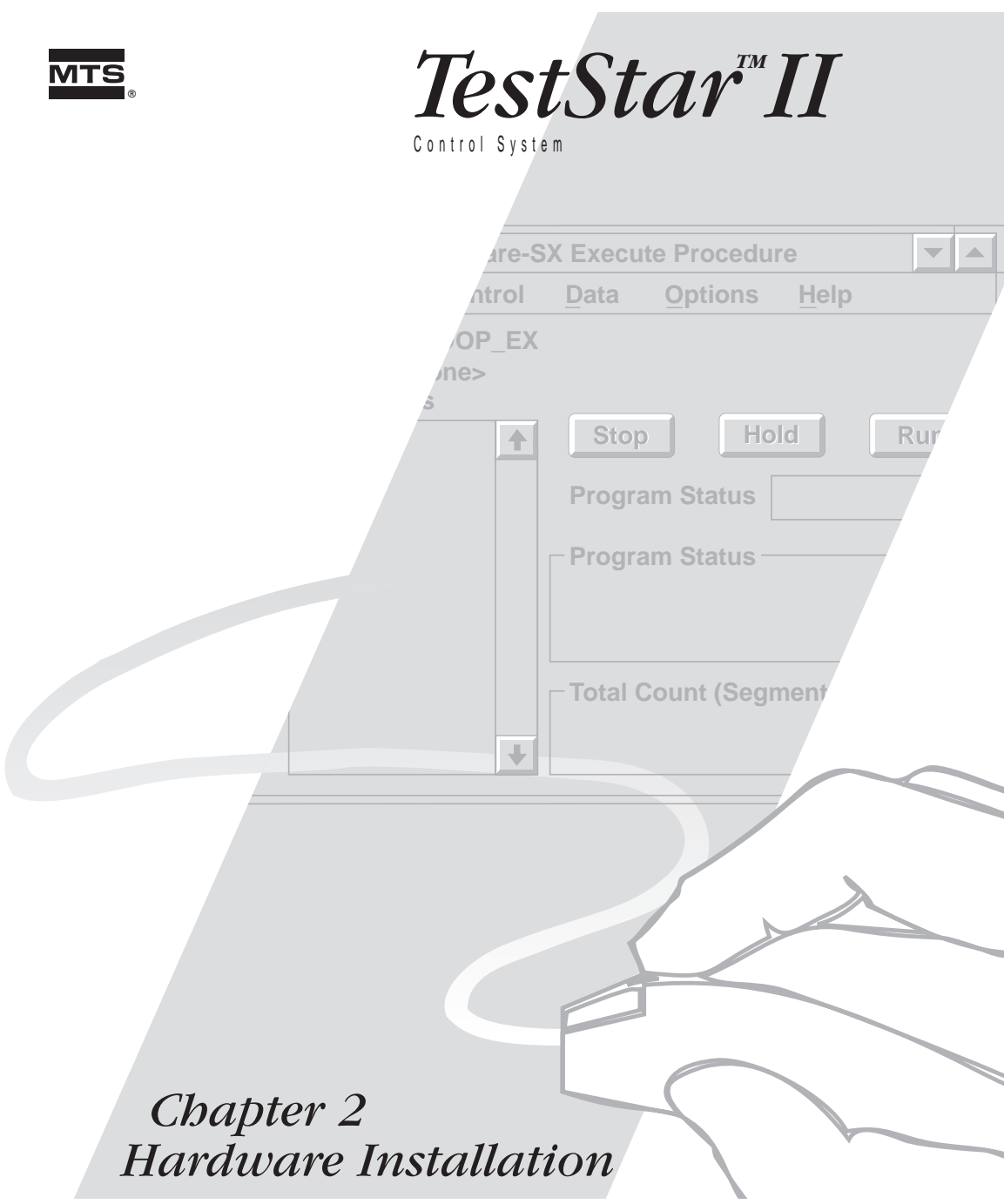

## *Chapter 2 Hardware Installation*

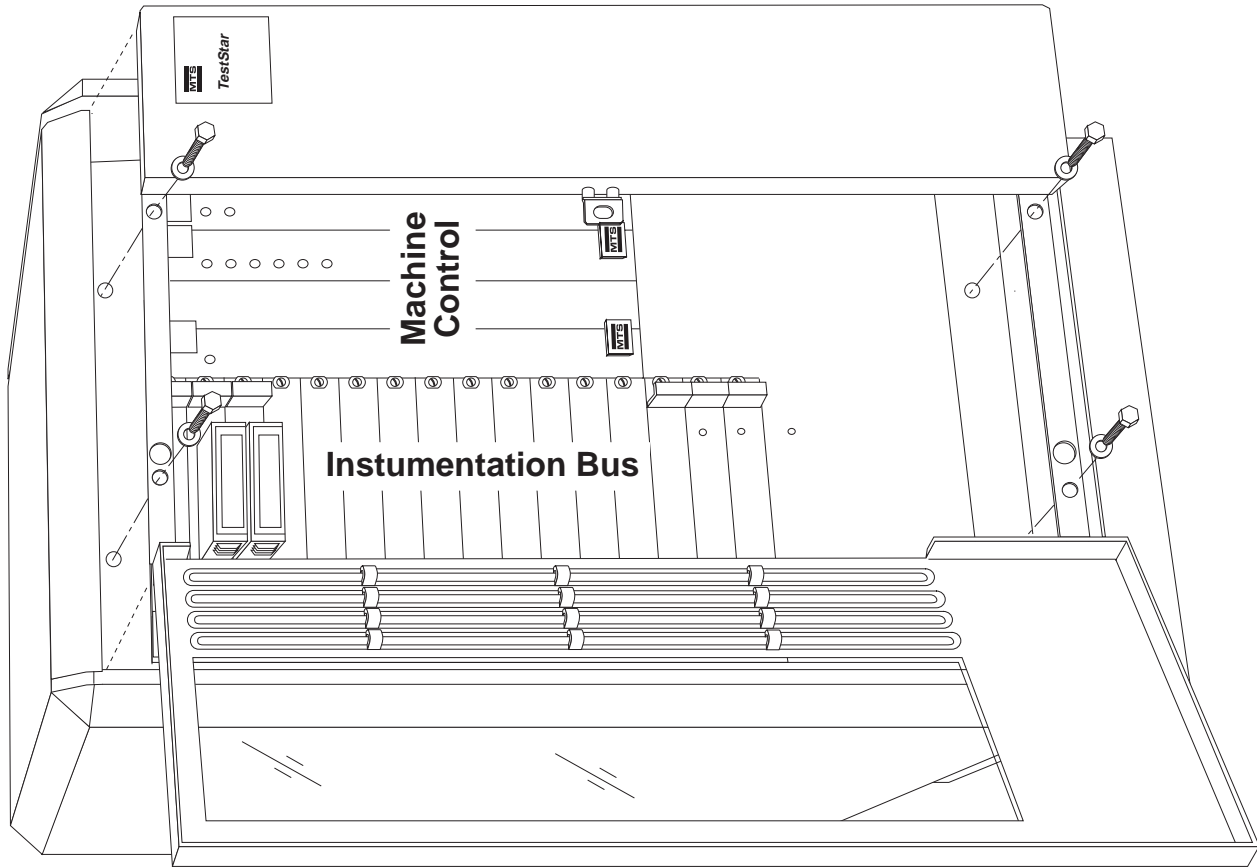



# Hardware Installation

---

This chapter describes how to install the TestStar hardware components.

---

## Contents

- Section A: Installing the Digital Controller 42
  - Section B: Installing the Plug-in Modules 46
  - Section C: Installing the Workstation Communication Interface 69
  - Section D: Installing the Load Unit Control Panel 73
  - Section E: Setting Up a Sensor Cartridge 75
  - Section F: Special Hardware Packages 79
- 

## Overview

**Section A** provides information about mounting the digital controller, along with power and grounding requirements.

**Section B** provides required module locations for the machine control modules and guidelines for the conditioner and valve driver module locations. Module jumper configurations are also described.

**Section C** provides instructions to install the Workstation Communication Interface circuit card into the host computer. Circuit card jumpers are also described.

**Section D** provides instructions to install the load unit control panel to the load unit or the free-standing pedestal.

**Section E** provides information about the sensor cartridge, selecting shunt calibration and bridge completion resistors.

**Section F** provides information about optional hardware packages that allow TestStar to be used with special hardware applications.

---

# Section A: Installing the Digital Controller

---

The digital controller is available in two basic configurations:

- ◆ Floor-standing
  - ◆ Console mount (vertical or table top consoles)
- 

## Floor-standing installation

The floor-standing TestStar chassis can be placed on the floor between the load unit and the workstation. The location is limited only by the length of the system cables.

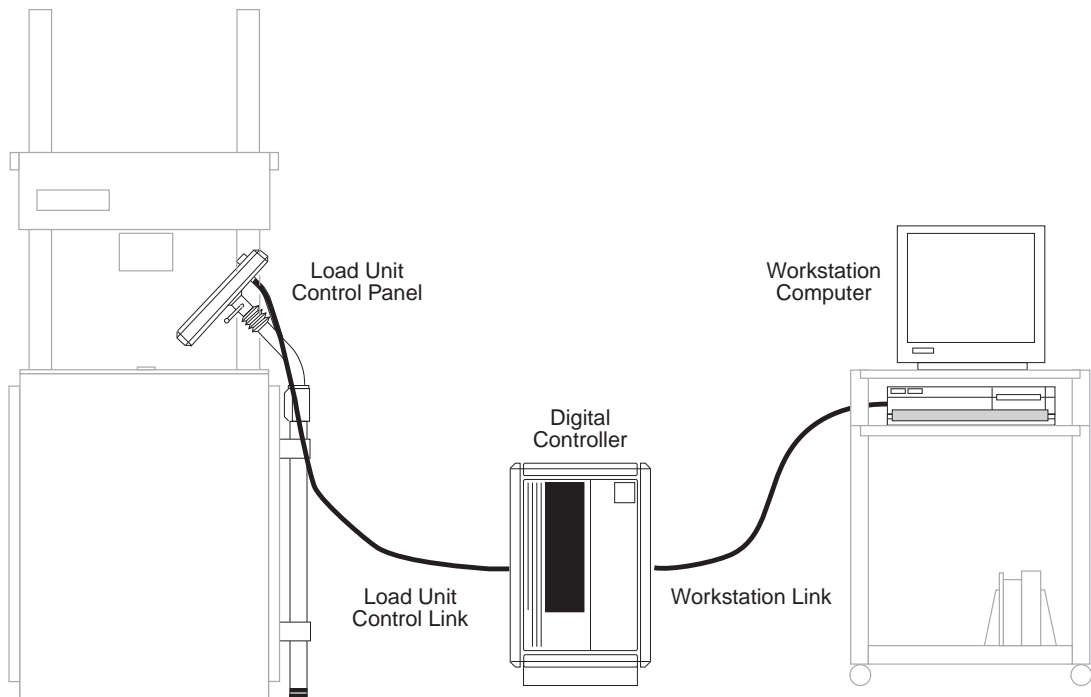

The load unit control panel is located near the load unit. The digital controller is typically located near the workstation (to accommodate the common electrical power requirements).

---

## Console installation

The TestStar chassis can be installed in any Model 490.8x console. Install the console with the Rack Assembly kit (part number 466998-01).

The Rack Assembly kit provides the hardware (L-shaped brackets) to support the digital controller and mounting screws to secure the chassis to the console rack.

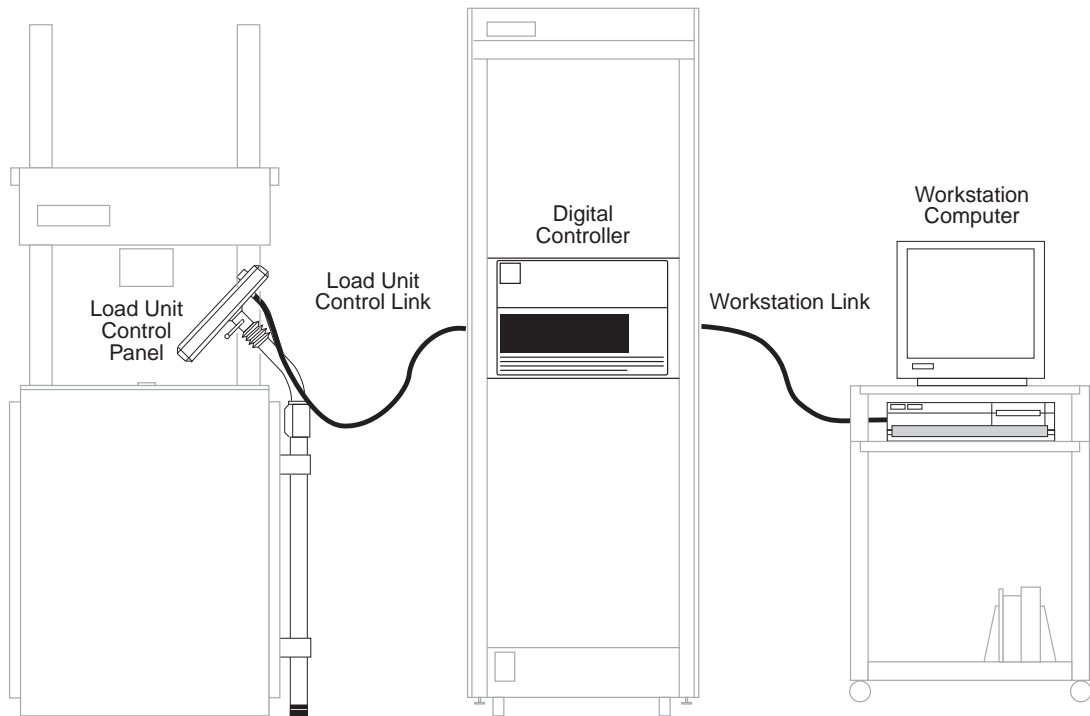

The Load Unit Control panel is located near the load unit. The digital controller can be installed in any console location since it has no operator controls.

# Digital Controller Grounding

**Note** TestStar will not function correctly if it is not grounded as shown. Be sure your power source is also properly grounded. See the Power and Grounding drawing p/n 470853-01 for detailed information.

The digital controller includes two grounds: a chassis ground and a power ground.

The two grounding lugs are connected together with a shorting wire when the chassis is manufactured.

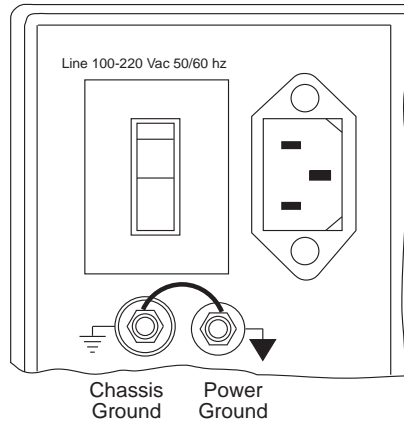

Floor-Standing Configuration

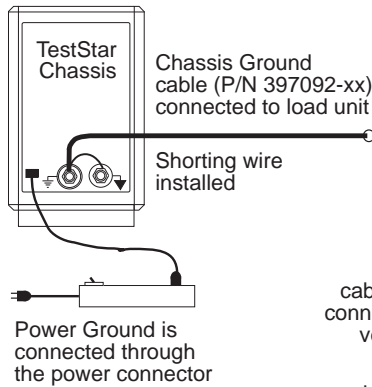

Console Configuration

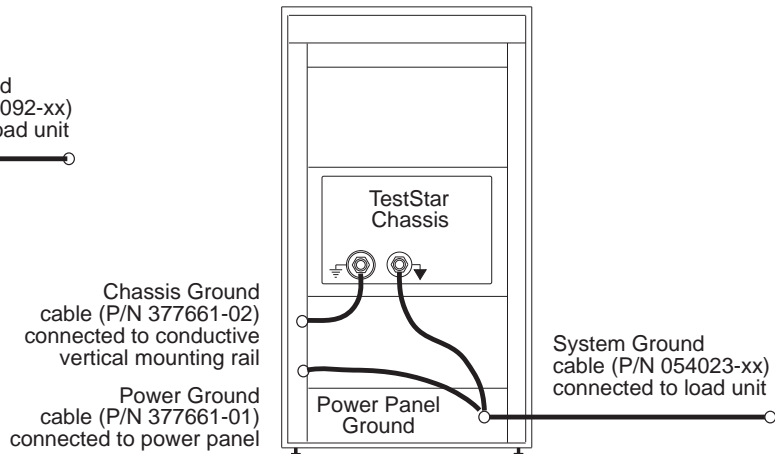

- ◆ For the **console configuration**, remove the shorting wire from the ground lugs and connect the chassis ground to the load unit.
- ◆ For a **floor-standing configuration**, always connect the shorting wire to both ground lugs.

## Digital Controller Power

All equipment related to TestStar should be connected on the same fused power circuit.

- ◆ The power supply can accept single-phase voltages within 90 - 125 Vac and 200 - 250 Vac at frequencies of 50 and 60 Hz.
- ◆ The nominal operating current is 5 A. The initial surge when power is applied is <math><68\text{ A}</math>. A 15 A line should be adequate for the TestStar chassis and the computer.
- ◆ The power supply automatically selects the proper voltage range and line frequency.
- ◆ The power supply is fused with a circuit breaker. If the circuit breaker trips, turn power off, wait several seconds, then turn power back on.

An outlet strip is supplied with the floor-standing chassis.

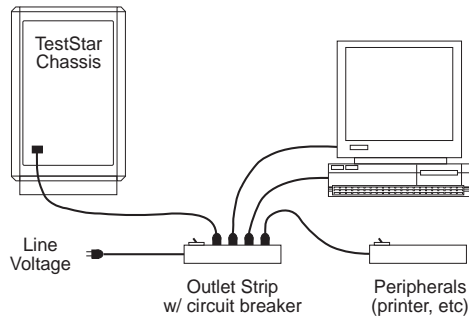

The computer components may be plugged directly into the outlet strip of a vertical console or a floor-standing console.

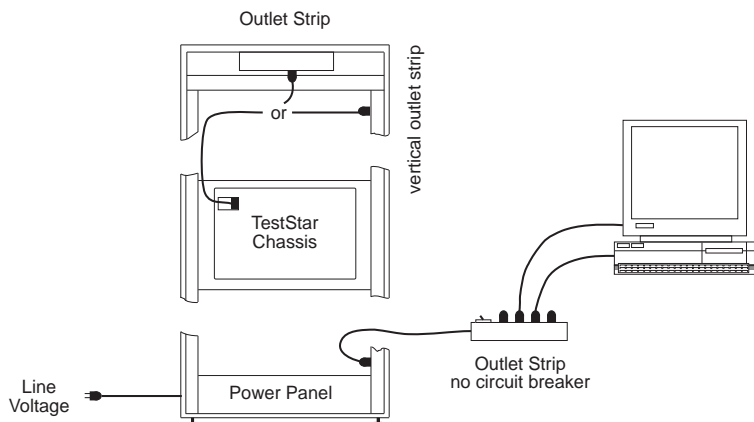

# Section B: Installing the Plug-in Modules

---

This section describes how to install the plug-in modules into the digital controller. Module installation involves configuring the module jumpers and identifying the proper module location.

**Note** *Digital controllers configured at MTS are configured for your application and have the modules installed in appropriate locations.*

---

## Contents

Module Locations	48
490.22 AC Conditioner Jumpers	50
490.21 DC Conditioner Jumpers	54
490.14/.17 Valve Driver Jumpers	59
490.60 Hydraulic I/O Jumpers	62
490.50 Processor Jumpers	64
490.70 Instrumentation Bus Controller Jumpers	65
Link/Processor Speed Jumpers	66

### CAUTION

**The TestStar plug-in modules contain static-sensitive components. Improper handling of the module can cause component damage.**

Be sure the you use the following precautions when handling TestStar modules:

- ◆ Turn off electrical power before installing or removing a module.
  - ◆ Use a ground strap to ground yourself to the TestStar chassis ground before touching the chassis or a module.
  - ◆ Keep unused modules in conductive bags. Also be sure you are grounded when removing a module from a conductive bag.
  - ◆ Handle modules with their front panel or circuit card edges. Do not touch any circuit card components, pins, or circuit connection points.
-

## Module installation

All modules slide into circuit card guides that align the module connector with a back plane connector. Push the module into the desired module location until the module and rear panel connector seat. Secure each module in place with the captive screws.

## Module jumpers

Jumpers are usually set during installation and should not need to be changed. Most systems use the standard jumper configurations. However, you may want to review the jumper configurations for each plug-in module to determine the functions that can be configured.

Two types of jumpers are used. Jumper blocks can be easily changed and are considered user configurable. Wire jumpers soldered to the circuit card and are configured to accommodate nonstandard system requirements.

Jumper Block Wire Jumper



## Plug-in modules

The following is a list of the plug-in modules:

MODEL	MODULE	DESCRIPTION
490.21	DC Conditioner	Interfaces with dc-type sensors (such as a force sensor).
490.22	AC Conditioner	Interfaces with ac type sensors (such as an LVDT).
490.14	Valve Driver	Controls a dual-stage servovalve (such as the Series 252 Servovalves).
490.17	Valve Driver	Controls a three-stage servovalve requiring inner loop conditioning (such as the Series 256 and 257 Servovalves).
490.40	Analog I/O	Provides all analog-to-digital and digital-to-analog conversions.
490.50	Processor	Manages the digital controller communications with the workstation and all the digital controller functions.
490.60	Hydraulic I/O	Controls the hydraulic functions and rear panel relay I/O.
490.72	Instrumentation Bus Interlock	Monitors the modules installed in the instrumentation bus for interlocks.
490.70	Instrumentation Bus Controller	Provides communication between the instrumentation bus and the machine control modules.

## Module Locations

**Note** Be sure all modules and blanks are installed and secured to the chassis. This provides the maximum ESD (electrostatic discharge) protection.

All the plug-in modules have required locations except the ac conditioner, dc conditioner, and valve driver modules.

Those modules are installed in the instrumentation bus according to the guidelines on the next page.

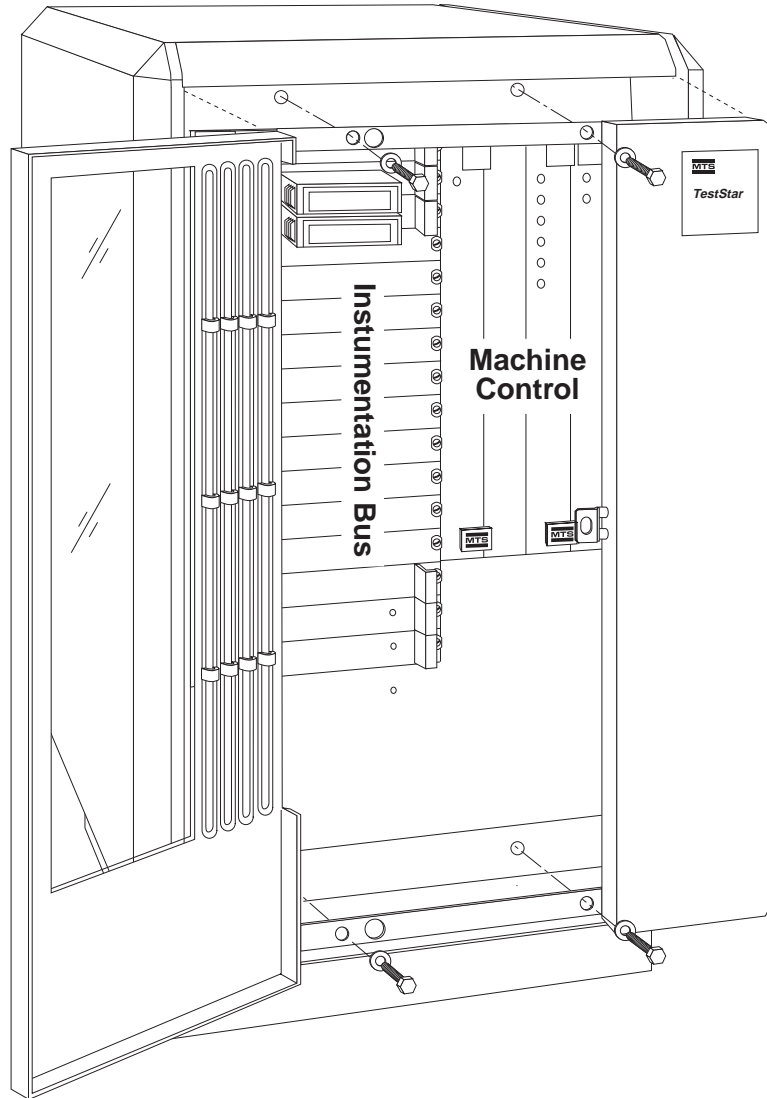



## Machine control modules

The machine control modules are located in the module rack at the top of the chassis (module locations 17 through 20). These modules simply plug into their designated module location.

Install the machine control modules in the following locations:

MODULE	LOCATION
Model 490.60 Hydraulic I/O	slot 17
Model 490.50 Processor	slot 18
Model 490.40 Analog I/O	slot 20
Extended Analog I/O option (see page 104) or High Speed Data Acquisition board	slot 19

## Instrumentation bus modules

The instrumentation bus modules are located along the bottom of the chassis (module locations 1 through 16). These modules plug into the appropriate module location and are secured with two screws.

Install the instrumentation bus modules using the following guidelines (the conditioner modules can be installed in any order in slots 1 - 14):

MODULE	LOCATION	NOTES
Model 490.22 AC Conditioner	1 - 14	Install all AC conditioners beginning at module location 1 and up (to the right of 1).
Model 490.21 DC Conditioner	1 - 14	Install all DC conditioners in the module locations to the right of the AC conditioners.
Model 490.14/.17 Valve Driver	11 -14	Install all valve drivers beginning at location 14 (Control Channel 1) and down (to the left of 14).
Model 490.72 Instrumentation Bus Interlock	15	Required location
Model 490.70 Instrumentation Bus Controller	16	Required location

## 490.22 AC Conditioner Jumpers

### Excitation drive

Jumpers X6, X7, X8, and X9 select constant-current or constant-voltage excitation drive. These jumpers are configured with a single jumper block.

- ◆ MTS sensors use constant-voltage excitation.
- ◆ Check the sensor calibration sheet to determine if the sensor excitation requires voltage or current.

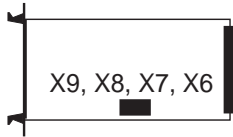

Constant Voltage  
(standard configuration)

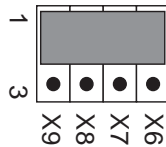

Constant Current

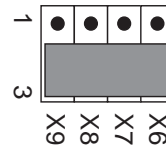

### Transducer zero

Jumper X15 allows the transducer zero to be applied to the input or output of the postamp.

- ◆ Applying zero to the output allows range changing without readjustment of transducer zero.
- ◆ Applying zero to the input allows nulling large offsets before gain is applied.

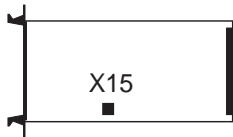

Output



Input  
(standard configuration)

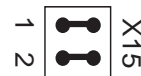

## Clock, phase sync, and AC reference

These signals can be input from an external location (the Analog I/O module) or an internal location (an optional daughter board mounted to the AC Conditioner).

- ◆ Jumper X10 selects the source of the clock signal for phase determination. The clock signal is 5.12 MHz.
- ◆ Jumper X11 selects the source of the phase sync signal for phase determination. The sync signal is a 10 kHz signal.
- ◆ Jumper X12 selects the source of the AC reference signal for the excitation reference. The reference signal is 10 kHz, 10 Vp-p.
- ◆ All three jumpers should be configured the same.

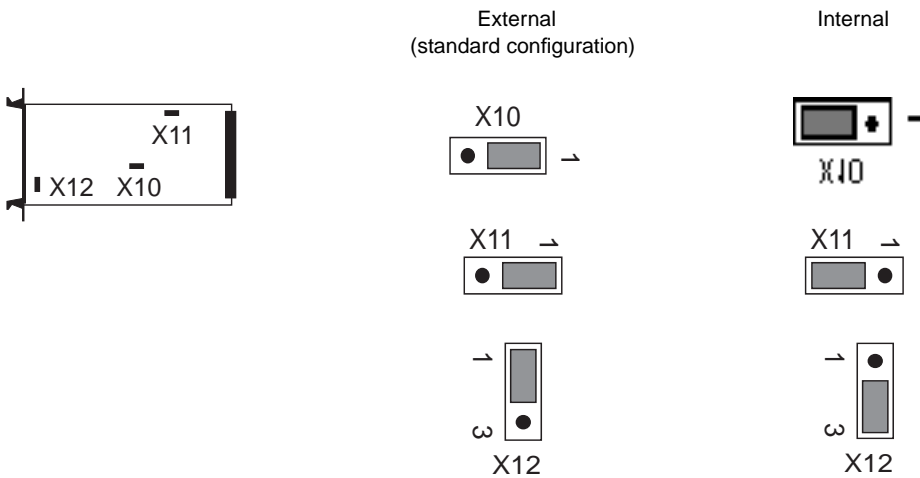

## Optional readout

Jumper X20 allows the unmodulated AC feedback signal to be routed to the Analog Bus for readout.

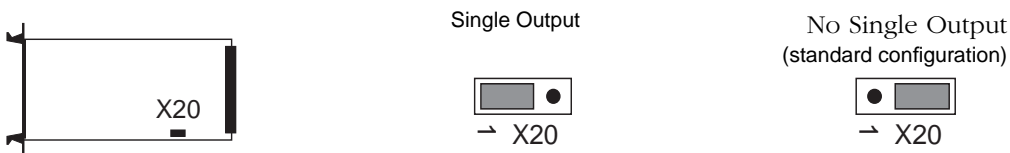

## Filter options

The conditioner filter is a daughter board that can be configured for a filter personality (refer to the filter personality jumpers on the next page). The filter can be assigned to one of three circuit locations.

- ◆ Jumper X14 connects the filter to the input of the postamp. This permits range changes without having to wait for the filter to settle.
- ◆ Jumper X16 connects the filter to the output of the postamp. This provides lower noise.
- ◆ Jumper X17 connects the filter to the monitor amplifier. This reduces noise and improves readout resolution.
- ◆ Configure all three jumpers according to the desired option.

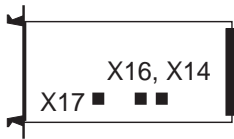

Postamp Input  
(standard configuration)

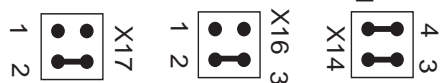

Postamp Output

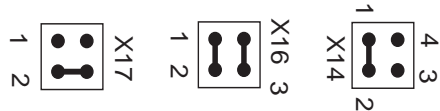

Monitor Amplifier

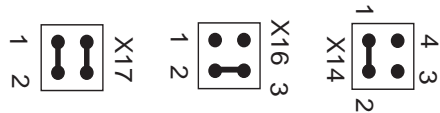

## External program select

Jumper X19 allows an external sensor signal to be input to the post amplifier.

- ◆ The external sensor signal must be within  $\pm 10$  volts full-scale.
- ◆ The external sensor signal is input through connectors J1 - J16. Use a connector associated with an unused module location.

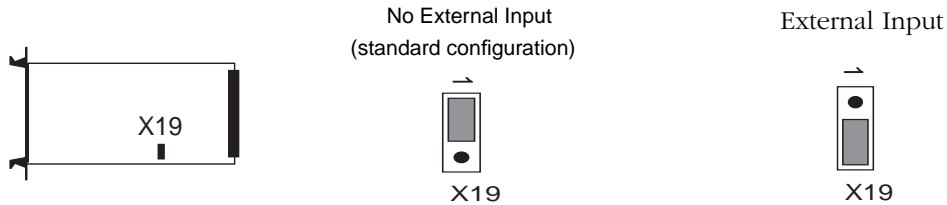

## Filter personality

The filter personality daughter board includes jumpers to identify the filter frequencies. The jumper settings for X1 and X2 identify the high and low filter frequencies. These jumpers do not configure the filter personality. The jumpers are factory set to identify the filter personality by outputting a specific voltage to the analog bus.

- ◆ The standard filter is a 500/50 Hz Butterworth filter personality. All other configurations are undefined



## 490.21 DC Conditioner Jumpers

### 4 or 8-Wire sensor cable

Jumpers X1 and X2 establish the correct shunt calibration connections for 4-wire and 8-wire sensor cables. The length of the sensor cable determines which type of cable is used. Short cables are typically 4-wire cables while long cables are typically 8-wire cables.

- ◆ Jumper X1 selects a 4- or 8-wire transducer for negative shunt calibration.
- ◆ Jumper X2 selects a 4- or 8-wire transducer for positive shunt calibration.
- ◆ Both jumpers should be set for the same configuration.

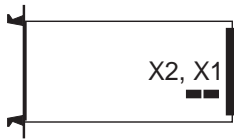

4-Wire Cable  
(standard configuration)

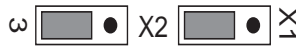

8-Wire Cable

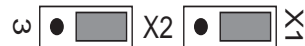

### Active guard drive

Jumper X3 selects active or passive guard drive for the sensor cable.

- ◆ A passive guard drive is used with 4-wire sensor cables.
- ◆ An active guard drive is used with 8-wire sensor cables to reduce line-related noise in a high-noise environment.

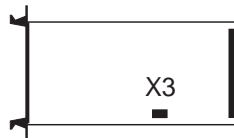

Active

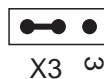

Passive  
(standard configuration)

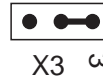

## Excitation feedback

Jumpers X4 and X5 select the local (on board) or remote (through cable) excitation feedback connection.

- ◆ The local selection is used with 4-wire transducer connections or constant-current applications.
- ◆ The remote selection is used with 8-wire transducer connections.
- ◆ Jumper X4 configures the +excitation signal.
- ◆ Jumper X5 configures the -excitation signal.
- ◆ Both jumpers should be set for the same configuration.

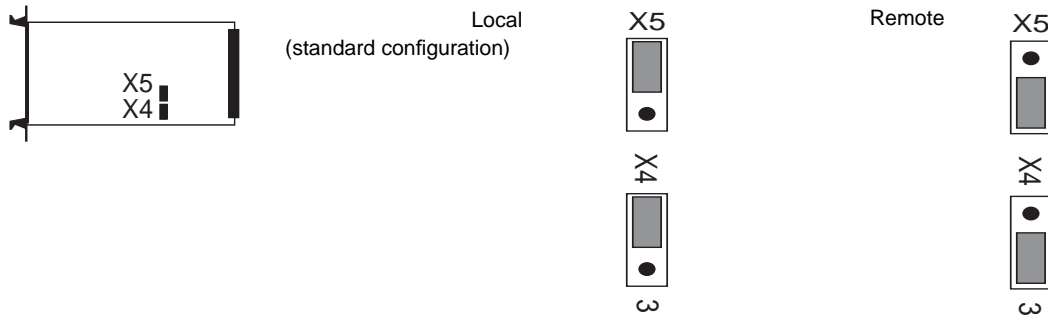

## Excitation drive

Jumpers X6, X7, X8, and X9 select constant-current or constant-voltage excitation drive.

- ◆ Most sensors use constant-voltage excitation.
- ◆ Check the sensor calibration sheet to determine if the excitation requires a voltage or current.
- ◆ All of these jumpers should be set for the same configuration.

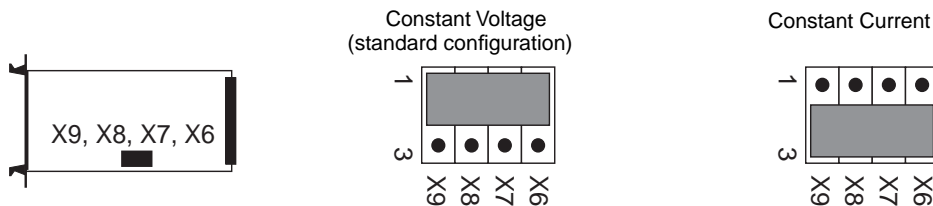

## Transducer zero

Jumper X15 selects the destination of the transducer zero signal.

- ◆ Applying zero to the post amp output allows range changing without readjustment of transducer zero.
- ◆ Applying zero to the post amp input allows nulling large offsets before gain is applied.



Post Amp Output

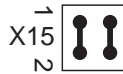

Post Amp Input  
(standard configuration)

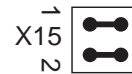

## Filter options

The conditioner filter is a daughter board that can be configured for a filter personality (refer to the filter personality jumpers). The filter can be assigned to one of three circuit locations.

- ◆ Jumper X14 connects the filter to the input of the postamp. This permits range changes without having to wait for the filter to settle because the filter is electronically in front of the gain range amplifier.
- ◆ Jumper X16 connects the filter to the output of the postamp. This provides lower noise.
- ◆ Jumper X17 connects the filter to the monitor amplifier. This reduces noise and improves readout resolution.



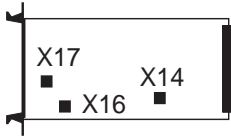

Configure all three jumpers according to the desired filter option:

Postamp Input  
(standard configuration)



Postamp Output



Monitor Amplifier



## External program select

Jumper X19 allows an external sensor signal to be input to the post amplifier.

- ◆ The external sensor signal must be within  $\pm 10$  volts full-scale.
- ◆ The external sensor signal is input through connectors J1 - J16. Use a connector associated with an unused module location.

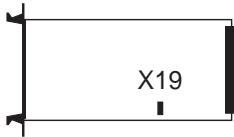

External Input

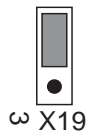

No External Input  
(standard configuration)



## Filter personality

The filter personality daughter board includes jumpers to identify the filter frequencies. The jumper setting for X1 and X2 identifies the high and low filter frequencies. These jumpers do not configure the filter personality. The jumpers are factory set to identify the filter personality by outputting a specific voltage to the analog bus.

- ◆ The standard filter is a 500/50 Hz Butterworth filter personality. All other configurations are undefined.

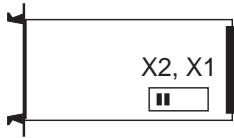

500/50 Butterworth  
(standard configuration)

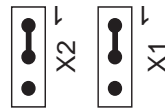

## 490.14/.17 Valve Driver Jumpers

### Valve clamp

Jumper X2 selects +10 V, -10 V, or common as the valve drive signal if there is an interlock. Jumper X8 must be enabled to use the valve clamp.

**Note** The following clamping descriptions assume normal servovalve phasing (refer to Chapter 1, step 7). If your system uses inverted phasing the descriptions for the  $\pm 10$  volt clamp selections should be reversed.

- ◆ Clamping to +10 volts causes the actuator to fully retract when an interlock is activated.
- ◆ Clamping to common causes the actuator to stop moving when an interlock is activated. Gravity and valve balance can cause the actuator to drift.
- ◆ Clamping to -10 volts causes the actuator to fully extend when an interlock is activated.

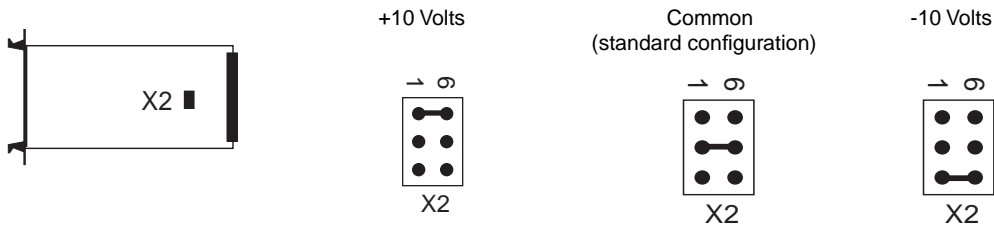

Jumper X8 allows an interlock signal to generate the valve clamp selected by jumper X2

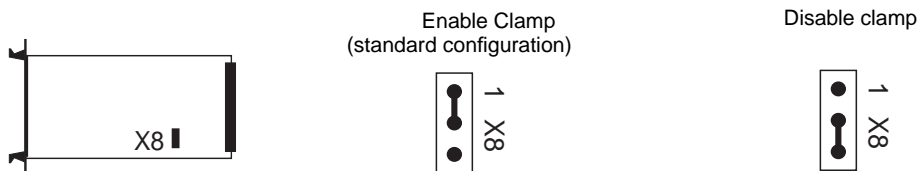

## Valve setup

Jumper X4 is set to accommodate single or dual valves, and voltage or current drive.

- ◆ Select a valve configuration and a drive configuration.
- ◆ The valve configuration applies only to pins 1 & 8, and 3 & 6.
- ◆ Check the number of servovalves on the actuator manifold to determine the servovalve configuration.
- ◆ The drive configuration applies only to pins 2 & 7, and 4 & 5.
- ◆ Series 252 and 256 Servovalves use a current drive signal. Series 257 Servovalves use a voltage drive signal (to the 448.16C Power Driver).
- ◆ The standard configuration has the jumpers removed (as shown with dashed box).

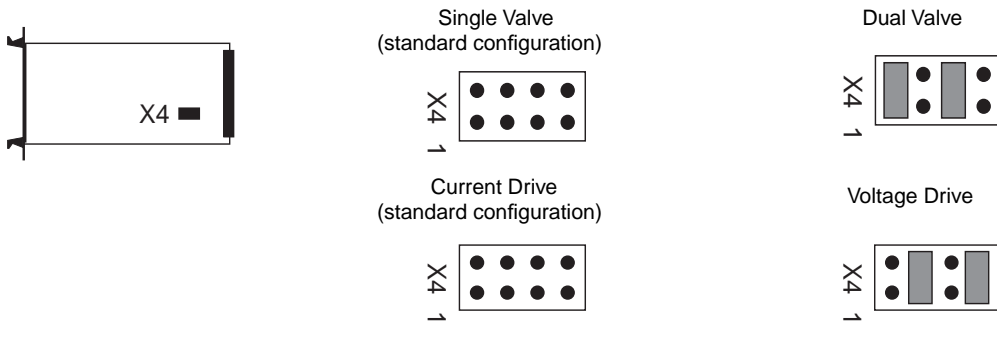

## Reset integrator control

Jumper X5 selects the control source for the reset integrator.

- ◆ The software control selection can turn the integrator on and off according to program requirements of optional software.
- ◆ The hydraulic on control selection turns the integrator on when the hydraulic pressure is applied. This selection also supports software control.



Software Control



Hydraulic On Control  
(standard configuration)

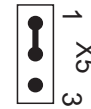

## Forward loop filter

Jumper X9 allows the optional forward loop filter to be applied to the servovalve command signal. The forward loop filter compensates for the resonance of the load unit when heavy grips are used.

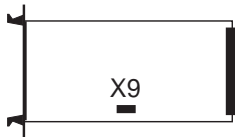

Not Connected  
(standard configuration)

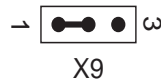

Connected

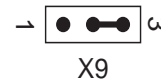

## 490.60 Hydraulic I/O Jumpers

---

### Crosshead interlock signal

Jumper X1 selects the polarity of an active crosshead interlock signal. MTS Series 318 and 380 Load Units generate an interlock with open contacts.

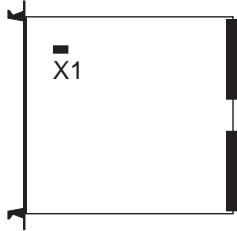

Interlock w/Contacts Open  
(standard configuration)



Interlock w/Contacts Closed



### Watchdog enable

Jumper X2 is provided for development purposes only. The jumper should be removed for normal operation.

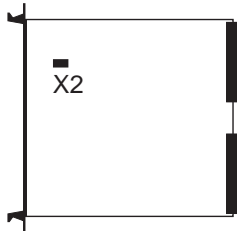

Watchdog Enabled  
(standard configuration)



Watchdog Disabled



## Hydraulic interlock configuration

Jumpers X5 and X6 determine how the relay outputs at J44 and J24 operate when a hydraulic interlock is detected. The relays can be configured to reset or maintain their current status when a hydraulic interlock occurs.

- ◆ Jumper X5 configures the run/stop relay contacts output through the rear panel connector J44.
- ◆ Jumper X6 configures the HSM auxiliary relay contacts output through the rear panel connector J24.

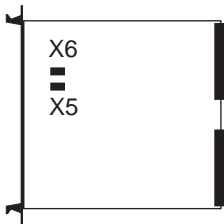

Does Not Reset Relays  
(standard configuration)



Reset Relays  
(standard configuration)



Reset Relays



Does Not Reset Relays



## Load unit configuration

Jumpers X7, X8, and X9 configure the crosshead lock input circuit for the type of load unit crosshead interlock circuit being used.

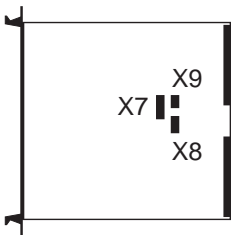

318 Load unit or equivalent  
(standard configuration)

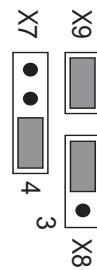

380 Load Unit

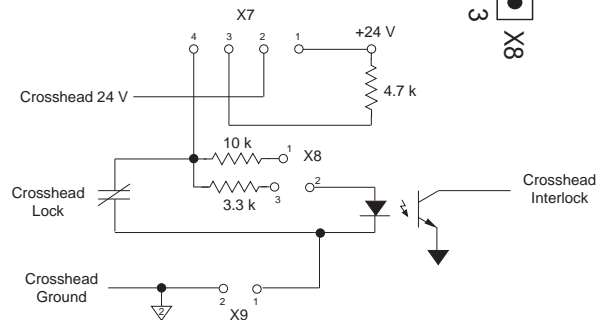
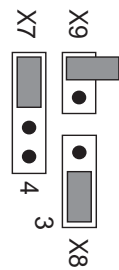

The schematic shows how the hydraulic interlock circuit can be configured.

# 490.50 Processor Jumpers

## digital input signal jumpers

These jumpers configure the inputs at connector J54 to be driven by relay contacts, switch contacts, or with logic levels. Twenty-four volts is also provided to the connector to allow use with other configurations such as OPTO-22, etc. Refer to Chapter 3 for information about interfacing with the J54 connection.

- ◆ Jumpers X1 through X8 correspond with the connector J54 input channels 1 through 8 respectively. Configure each input for the for the corresponding signal type.
- ◆ Jumper pins 1 and 2 for relay or switch contacts.
- ◆ Jumper pins 2 and 3 for a logic signal. The logic signal can be within 5 to 24 volts.

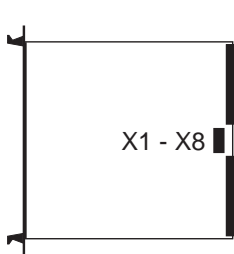

Logic Level  
(standard configuration Shown)

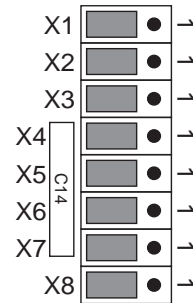

## System control source

Jumper X9 is provided for development purposes only. The jumper should be removed for normal operation.

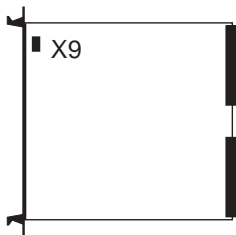

Workstation Control  
(standard configuration Shown)





## 490.70 Instrumentation Bus Controller Jumpers

### Bootstrap source

Jumper X1 is provided for development purposes only. The jumper should be installed across pins 2 and 3 for normal operation.

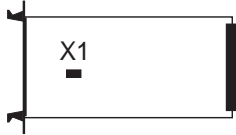

Boot From Link  
(standard configuration)



### Transputer link speed

Jumper X2 selects the transputer link speed for the Instrumentation Bus Controller module.

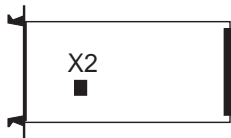

- ◆ The standard configuration is set at 20 MHz for all links (no jumpers installed).
- ◆ The link speed of all digital controller modules should be configured the same.

LINK SPEED (MHz)		JUMPER PINS		
Link 0	Links 1, 2, 3	1 & 6	2 & 5	3 & 4
20	20	out	out	out
20	10	in	out	out
10	20	out	in	out
10	10	in	in	out
10	10	in	in	in
10	5	out	in	in
5	10	in	out	in
5	5	out	out	in

## Link/Processor Speed Jumpers

The transputer link speed establishes the speed of communication between the workstation computer, the machine control modules of the digital controller, and the load unit control panel. The processor speed establishes the speed of the transputer processors. Transputer links and processors are located on the TI/O RAM daughter boards and the load unit control panel.

### Jumper configurations

Use the following tables to determine the jumper configurations for all transputer processors and links located on TI/O daughter boards.

- ◆ The link speed should be reduced to 10 MHz if the cable length between the digital controller and the workstation computer or load unit control panel exceeds 100 feet (30 meters).
- ◆ The link speed of all digital controller modules should be configured the same.

<b>JUMPER PINS</b>			
<b>Processor Speed</b>	<b>1 &amp; 6</b>	<b>2 &amp; 5</b>	<b>3 &amp; 4</b>
20 MHz	in	in	in
25 MHz	in	in	out
30 MHz	out	in	out

<b>LINK SPEED (MHz)</b>		<b>JUMPER PINS</b>		
<b>Link 0</b>	<b>Links 1, 2, 3</b>	<b>1 &amp; 6</b>	<b>2 &amp; 5</b>	<b>3 &amp; 4</b>
20 MHz	20 MHz	out	out	out
20 MHz	10 MHz	in	out	out
10 MHz	20 MHz	out	in	out
10 MHz	10 MHz	in	in	out
10 MHz	10 MHz	in	in	in
10 MHz	5 MHz	out	in	in
5 MHz	10 MHz	in	out	in
5 MHz	5 MHz	out	out	in

## TI/O RAM boards

The TI/O RAM daughter boards are used with the machine control modules. The daughter boards provide additional processing and memory capabilities for the modules in which they are installed.

Three types of TI/O RAM daughter boards are used.

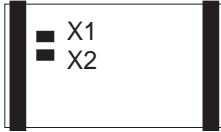

The T2S daughter board is used on the processor, analog I/O, and hydraulic I/O modules. The standard configuration for the T2 transputer is 20 MHz and link speeds of 20 MHz.

- ◆ Jumper X1 selects the processor speed.
- ◆ Jumper X2 selects the link speeds.

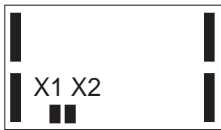
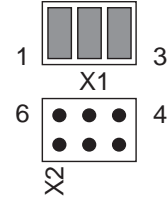

The T8D daughter board is used on the processor module. The standard configuration for the T8D transputer is 20 MHz and link speeds of 20 MHz.

- ◆ Jumper X1 selects the link speeds.
- ◆ Jumper X2 selects the processor speed.

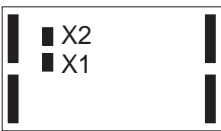
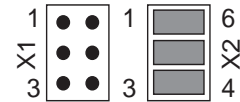

The T8S daughter board is used on the processor module. The standard configuration for the T8S transputer is 25 MHz and link speeds of 20 MHz.

- ◆ Jumper X1 selects the link speeds.
- ◆ Jumper X2 selects the processor speed.

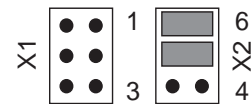



# Section C: Installing the Workstation Communication Interface

---

The workstation communication interface (WSCI) is a circuit card that is installed in the host computer (workstation). The WSCI circuit card provides the interface between the workstation and the digital controller.

## Installation procedure

---

Perform the following procedure to install the workstation communication interface circuit card into the host computer.

1. Review the WSCI jumper configurations on the following pages to determine if any changes are necessary. For most installations, the standard jumper configuration can be used.

**Note** *If you change jumper settings go to [WSCI Jumper Settings vs. Software Settings](#) on page 70.*

2. Refer to the computer product manual to remove the computer top cover.
  3. Select an unused circuit card connector in the computer chassis and remove the appropriate rear panel plate.
  4. Plug the WSCI circuit card into the selected circuit card connector.
  5. Secure the WSCI circuit card rear panel with the screw from the panel removed in step 3.
  6. Install the computer top cover.
  7. Connect the Workstation Link cable (part number 397033-xx) to the lower connector of the rear panel of the WSCI circuit card. The upper, 9-pin connector is not used.
-

## WSCI Jumper Settings vs. Software Settings

---

The jumper settings for the workstation communication interface circuit card must agree with certain software settings. The required software settings vary according to the version of TestStar that is installed.

**⚠ CAUTION**

---

**Changing jumper configurations can cause TestStar to be nonfunctional**

The jumper settings on the WSCI board must match any software reference.

---

### TestStar version 3.1

The board address, DMA channel assignment, and IRQ selection must agree with the TestStar DEVICE definition in the CONFIG.SYS file. If you change the standard configuration of the jumpers, you must edit the following line in the config.sys file to match your settings.

```
DEVICE=C:\TS2\mts$xpctr.sys -io 0x150 -irq 5 -dma 3
```

Make sure the -io, -irq, and -dma settings match the corresponding jumper settings.

### TestStar version 4.0

The interrupt setting must agree with the software setting. To check the setting proceed as follows:

1. Open the Administration Tools program folder.
2. Open the Windows NT Diagnostics program.
3. From the Tools menu, select Registry Editor. This opens the HKEY\_LOCAL\_MACHINE window where you will navigate to the proper location to check the WSCI interrupt setting.
4. Navigate by opening the following folders:

```
System
  CurrentControlSet
    Services
      WSCI
        WSCI0
          Parameters
```

5. Edit the Interrupt setting to match the jumper setting.
-

## Workstation Communication Interface Jumpers

### Board address

Jumpers X1 and X2 select the address of the Workstation Communication Interface board. The address identifies the location of the board registers to your computer.

- ◆ Change the address if you have a conflict with another circuit card.

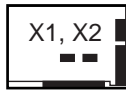

Address 150/160  
(Standard Configuration)



Address 300/310



Address 300/310

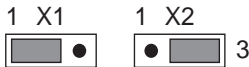

Board Disabled

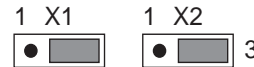

### Link speed

The link speed selection is accomplished with jumpers X3 and X4.

- ◆ Jumper X3 selects the link speed for links 0, 1, and 2.
- ◆ Jumper X4 selects the link speed for link 3.
- ◆ The link speed should be 10 MHz if cable assembly 397034-xx is longer than 100 feet (30 meters). The link speed of the WSCI must match the link speed of the processor module.

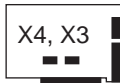

10 MHz



20 MHz  
(Standard Configuration)



## DMA channel assignment

### Version 4.0 Only

Jumpers X5 and X6 must be removed for the board.

Links 0 and 3 are capable of performing DMA transfers over the host bus. DMA channels 1 and 3 are available for use by links 0 and 3 if they do not conflict with another bus DMA device.

- ◆ Jumper X5 configures the DACK channel assignment for both links.
- ◆ Jumper X6 configures the DRQ channel assignment for both links.
- ◆ Change the configuration only if you have a conflict with another circuit card

DRQ and DACK must be treated as a pair of signals corresponding to a given DMA channel and assigned to the same link. If a channel is not used, both DRQ and DACK jumpers must be removed for that channel.

### Version 3.1 Only

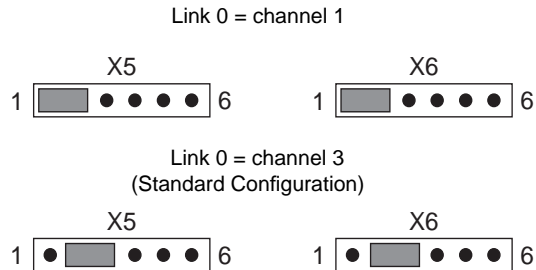
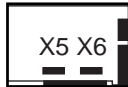

## Interrupt source

Jumper X7 provides the interrupt source level selection. Link 0 or link 3 is selected as the interrupt source. Interrupt level 3 or 5 is then assigned to the source selection.

- ◆ Do not select the same link for both interrupt levels.
- ◆ Change the configuration only if you have a conflict with another circuit card.

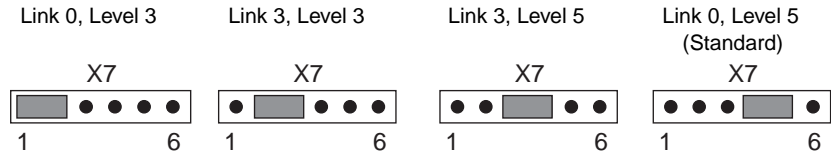



# Section D: Installing the Load Unit Control Panel

---

The load unit control panel is configured for the number of control channels in your system. Each control channel is configured for the type of service manifold (actuator manifold) that is used. You identify these configurations when the TestStar software is installed (Chapter 4).

The load unit control panel can be attached to the load unit or a free-standing pedestal.

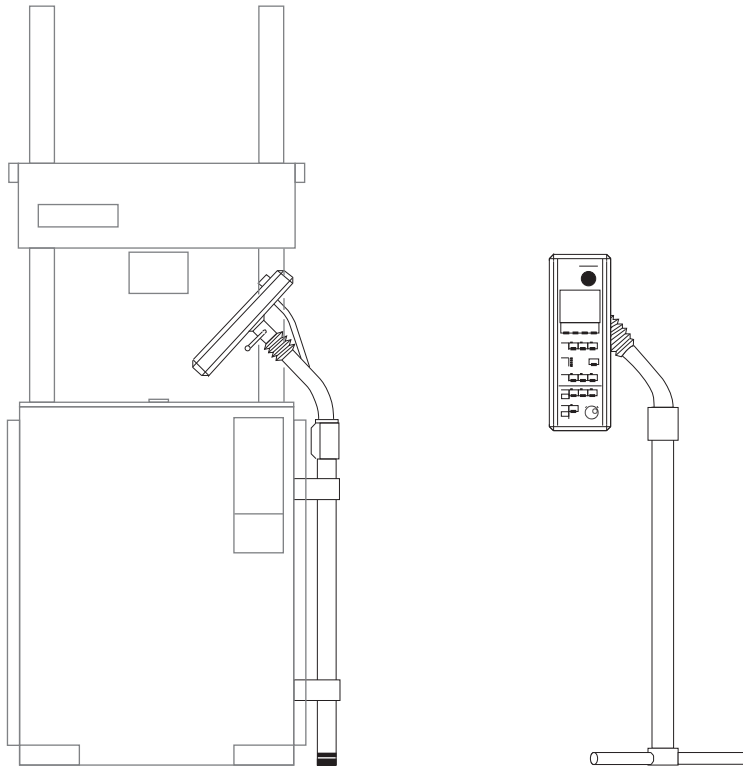

## Load unit control panel installation

The following procedure applies to the load unit and free-standing pedestal configurations.

1. Remove the threaded rubber grommets from the mounting plate screws on the load unit stand.
  2. Insert the threaded rubber grommets into the holes on the rear panel of the load unit control panel.
  3. Align the threaded grommets on the load unit control panel with the mounting plate holes of the stand.
  4. Secure the load unit control panel to the stand with the screws obtained in step 1.
  5. Connect Load Unit Control Panel Link cable (part number 397033-xx) to
  6. Connector J2 on the load unit control panel connects the load unit control panel Emergency Stop switch to the system.
- ◆ If connector J29 on the digital controller is to be connected to the load unit lift/lock controls, a pig-tail connector is provided for J2 of the load unit control panel (cable assembly numbers 397027-xx or 397028-xx).
  - ◆ If connector J29 on the digital controller is not to be connected to the load unit lift/lock controls, connect cable assembly 397030-xx to J2 of the load unit control panel.

# Section E: Setting Up a Sensor Cartridge

---

Each range of a resistive-bridge type transducer (dc sensor) uses a shunt calibration resistor to check the calibration accuracy of the sensor/conditioner combination. Each dc conditioner requires a sensor cartridge with a shunt calibration resistor for each calibrated range.

**Note** *Whenever a dc sensor is connected to the digital controller, be sure that the sensor cartridge associated with the sensor is installed in the corresponding dc conditioner module.*

## Removing the cartridge

The sensor cartridge is located in the front panel of a dc conditioner.

Squeeze the finger grips together and pull the cartridge out of the dc conditioner

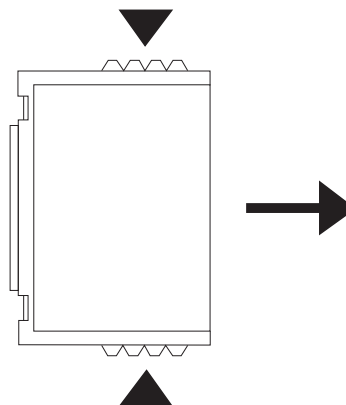

## Opening the cartridge

The sensor cartridge can be opened to access the circuit card where the shunt calibration and bridge completion resistors are located.

Release the tabs on the front of the cartridge and remove the top.

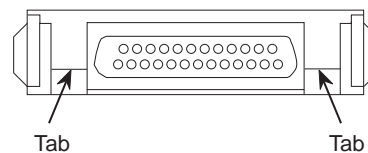

## Configure the cartridge

Add shunt calibration resistors or bridge completion resistors. See [Range Cartridge Resistors](#) on page 77 for details about shunt calibration and their location in the cartridge.

---

## Closing the cartridge

The cartridge shell has an interlocking channel at the rear of the two shell pieces. The channel acts like a hinge.

Seat the rear channel of the two pieces and snap the cartridge shell closed.

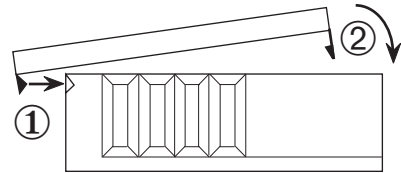

## Installing the cartridge

The sensor cartridge is associated with the sensor for which the shunt calibration resistors were selected. Be sure the label on the sensor cartridge matches the dc conditioner and associated sensor.

Install the cartridge into the selected dc conditioner with the cartridge label facing to the right of the digital controller.

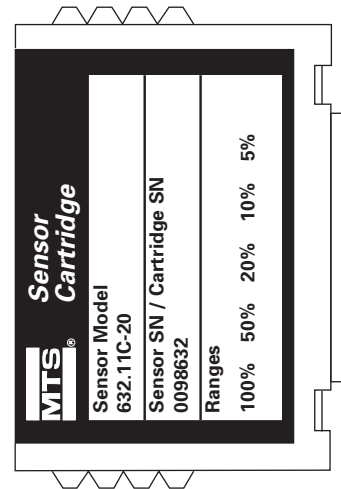

## Range Cartridge Resistors

Each sensor cartridge includes a selection of shunt calibration resistors. Resistor selection is based on the sensor bridge resistance and sensitivity. Refer to the calibration data sheet, final inspection card, product specification sheet, or product manual for the bridge resistance and sensitivity.

### Standard shunt cal values

MTS part number 468582-01 includes the following shunt cal resistor set. These are recommendations for shunt calibration resistors.

BRIDGE RESISTANCE	SENSITIVITY*	GAIN RANGE	RESISTOR	MTS P/N
350 $\Omega$	2 mV/V	x1	49.9 k	113407-22
		x2	100 k	113407-28
		x5	249 k	113407-29
		x10	499 k	113407-30
350 $\Omega$	1 mV/V	x1	100 k	113407-28
		x2	200 k	113407-26
		x5	499 k	113407-30
		x10	1000 k	113407-31
700 $\Omega$	2 mV/V	x1	100 k	113407-28
		x2	200 k	113407-26
		x5	499 k	113407-30
		x10	1000 k	113407-31
700 $\Omega$	1 mV/V	x1	200 k	113407-26
		x2	402 K	113407-24
		x5	1000 k	113407-31
		x10	2000 K	118793-07

\* Sensitivity is sensor output per volt of excitation.

### Bridge Resistors

Bridge completion accommodates quarter and half bridge strain gages. The sensor cartridge provides locations for bridge completion resistors. Two and three wire bridge completion and bridge balancing are also supported. See [Strain Gage Calibration](#) on page 405.

## Resistor locations

Install the selected resistors in their appropriate circuit card location. You need to know the value of the shunt cal resistors for each range you calibrate. Record the value of each resistor for future reference.

The sensor cartridge includes resistor locations for up to 5 shunt calibration resistors (R1 - R5) and 3 bridge completion resistors (R6 - R8).

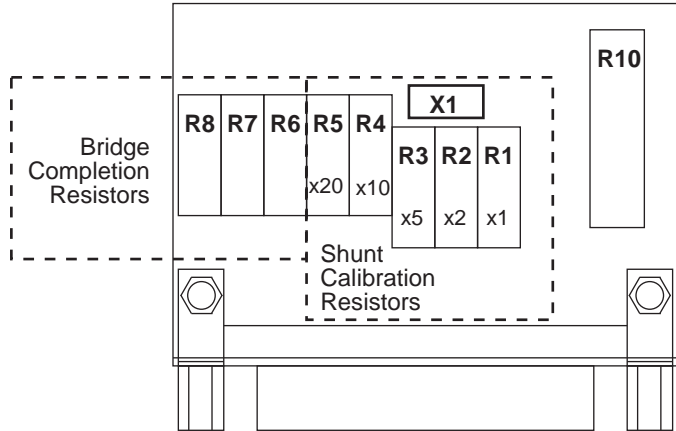

# Section F: Special Hardware Packages

---

Several optional kits are available to accommodate special hardware configurations.

<b>Contents</b>	Model 380 Load Unit Interface Package	81
	Model 490.17 Valve Driver Package	84
	Model 448.16C Power Driver Package	87
	Multiple HSM Channels	88
	Forward Loop Filter Package	92
	±15 Volt Power Package	95
	ADT Support Package	98
	115 Vac Solenoid Interface	100
	Extended Analog I/O	104
	Production QC	106

## **CAUTION**

**The TestStar plug-in modules contain static-sensitive components. Improper handling of the modules can cause component damage.**

Be sure the you use the following precautions when handling TestStar modules:

- ◆ Turn off electrical power before installing or removing a module.
- ◆ Use a ground strap to ground yourself to the TestStar chassis ground before touching the chassis or a module.
- ◆ Keep unused modules in conductive bags. Also be sure you are grounded when removing a module from a conductive bag.
- ◆ Handle modules with their front panel or circuit card edges. Do not touch any circuit card components, pins, or circuit connection points.

## The hardware packages

The following are brief descriptions of the optional hardware packages.

- ◆ The **Model 380 Load Unit Interface** package (part number 474393-01) describes how to interface TestStar with a Model 380 Load Unit.
  - ◆ The **Model 490.17 Valve Driver** package (part number 445615-xx) includes the valve driver and hardware to add a rear panel connector to support the inner loop LVDT from a 3-stage servovalve.
  - ◆ The **Model 448.16C Power Driver** package is required for the Series 257 Servovalve. This kit (part number 474396-xx) includes a Model 448.16C Power Driver and interface cables.
  - ◆ The **Multiple HSM Channels** packages allow more than one HSM to be used with TestStar. Two kits are available; part number 474391-xx supports multiple proportional HSMs; part number 476137-xx supports multiple solenoid HSMs.
  - ◆ The **Forward Loop Filter** package (part number 477605-01) includes a daughter board for the Model 490.14 or Model 490.17 Valve Driver. The forward loop filter kit helps prevent load frame resonance on systems with heavy grips.
  - ◆ The **±15 Volt Power** package (part number 474392-01) includes the required hardware to add a rear panel connector to provide ±15 volts to external equipment. This package is required for Tempo sonic transducers and the Series 633 Extensometer.
  - ◆ The **ADT Support** package (part number 474394-01) provides information to modify a Model 490.21 DC Conditioner for use with an angular displacement transducer.
  - ◆ The **Extended Analog I/O** package (part number 474394-01) includes a second Analog I/O module that allows an additional sixteen external analog signals to be used by TestStar.
  - ◆ The **Production QC** package supports a software option for the Dynamic Characterization and Static Deflection application. It is designed to test materials and components in a manufacturing environment
-



## Model 380 Load Unit Interface Package

The Model 380 Load Unit Interface package (part number 474393-01) includes a special cable to interface TestStar with a Model 380 Load Unit. Installing the interface consists of two parts:

- ◆ configuring jumpers
- ◆ connecting the cable

### Configure the jumpers

The required jumper configuration is accomplished on the Model 490.60 Hydraulic I/O module. Perform the following to set the jumper configuration:

7. If the Hydraulic I/O module is installed in the chassis, remove the front panel. Open the hinged panel and remove the 4 hex screws that secure the front panel to the chassis.
8. Remove the Hydraulic I/O module from slot 17 (top module). Loosen the 4 screws that secure the module to the machine control rack, then pull the module out of the rack.
9. Locate jumpers X7, X8, and X9 on the Hydraulic I/O module and configure them as shown.

The 380 Load Unit configuration for jumpers X7, X8, and X9.

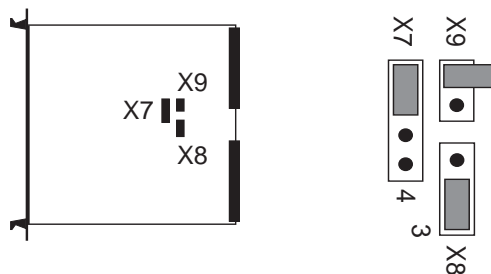

10. Install the Hydraulic I/O module into slot 17 and secure the module to the chassis with the 4 screws.
11. Replace the chassis front panel removed in step 1.

## Connect the cable

The cable assembly (part number 474399-xx) has seven connectors that interface the digital controller with the Model 380 Load Unit, the TestStar load unit control panel, and a 24 volt power supply (which provides power to the load unit solenoids). Connect the cable as follows:

- ◆ Connect P1 to the 24 volt power supply used with the 380 load unit.
- ◆ Connect P2 to the TestStar load unit control panel.
- ◆ Connect P7 to the control panel mounted on the load unit.
- ◆ Connect P13 to the control panel mounted on the load unit.
- ◆ Connect P29, P43, and P44 to the rear panel of the digital controller.

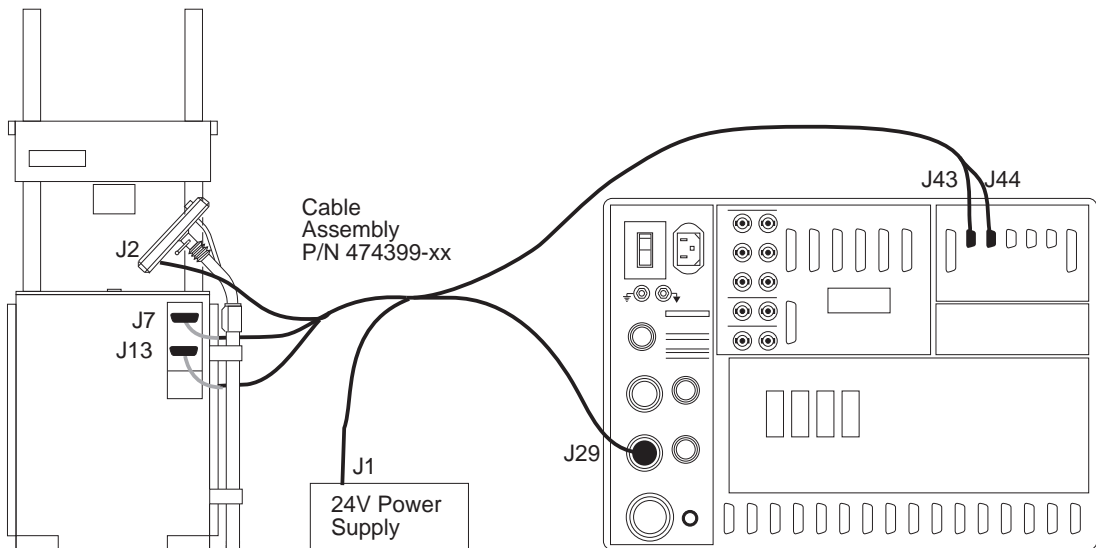

The connections for J7 and J13 on the load unit can be found behind the control panel, through the rear of the load unit.

## Cable assembly

The wiring diagram of the cable assembly part number 474399-xx is shown below.

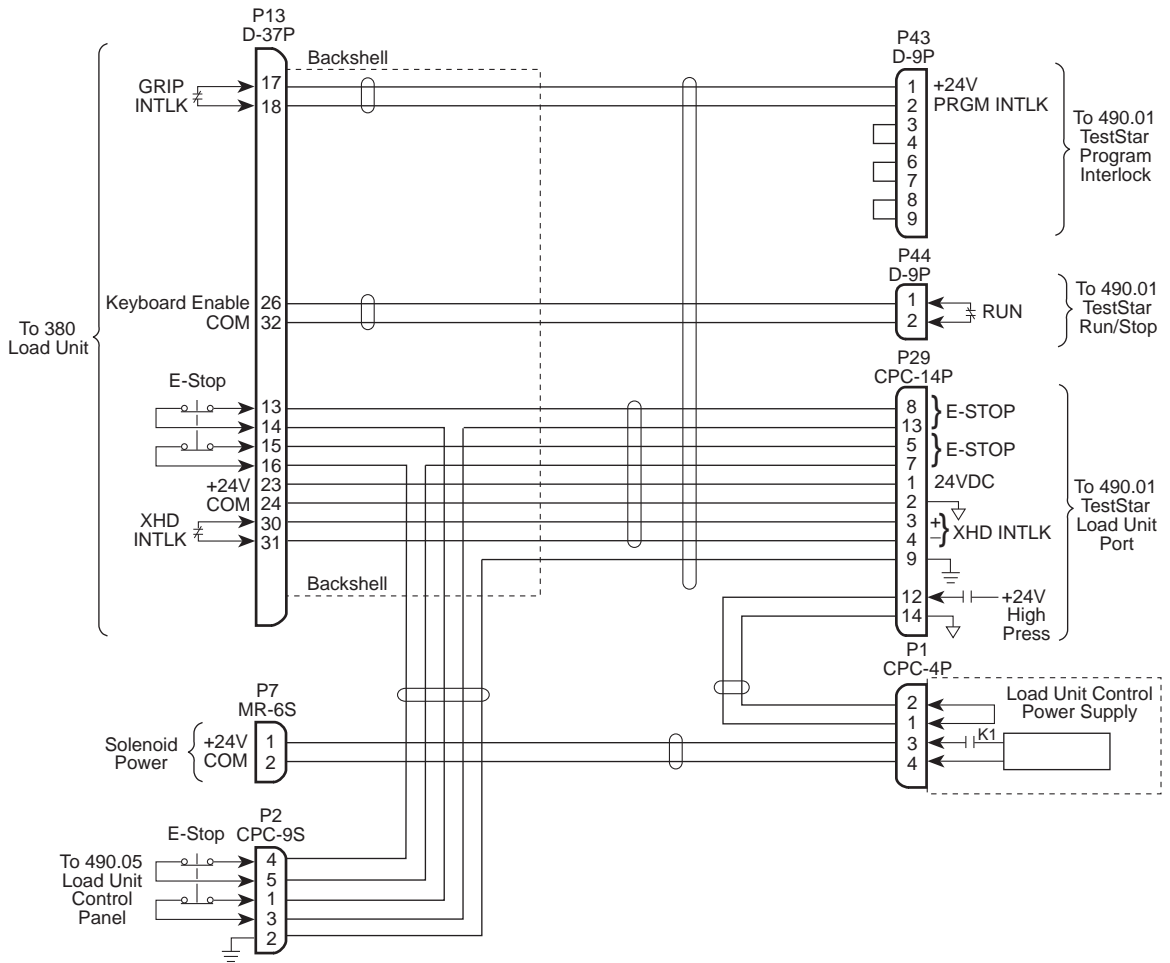

## Model 490.17 Valve Driver Package

---

The Model 490.17 Valve Driver Package (part number 445615-xx) includes the valve driver and the required hardware to add a rear panel connector to support the inner loop LVDT. The valve driver package has four configurations; each configuration is the same except for the cable labels.

PART NUMBER	MODULE LOCATION	AUX I/O CONNECTION
445615-01	14	J114
445615-02	13	J113
445615-03	12	J112
445615-04	11	J111

### Installation

1. Remove the Auxiliary I/O panel from the digital controller rear panel. The Auxiliary I/O panel contains connector locations marked J111 through J114 Aux I/O.
2. Install the Model 490.17 Valve Driver into the appropriate module location. The appropriate module location is slot 14 for a single valve driver or to the left of any existing valve drivers (slot 13, 12, or 11).
3. Identify the back plane connector of the valve driver module. The module location corresponds with the back plane connector. *For example*, module location 14 corresponds with the back plane connector location J114.
4. Remove the small panel from the selected connector location of the auxiliary I/O panel.
5. Install the two back plane connections of cable assembly 445616-xx to the pins of the selected back plane connector. A dot on each back plane connector corresponds with the back plane pins 19A and 21A. The connector locations are identified by the back plane markings that outline the connector locations.

*Continued...*

**Installation (continued)**

6. Install the 15-pin connector in the selected connector location on the auxiliary I/O panel with the hardware included. Also, secure the ground lug of the cable assembly to the panel along with the connector.
7. Reinstall the auxiliary I/O panel.

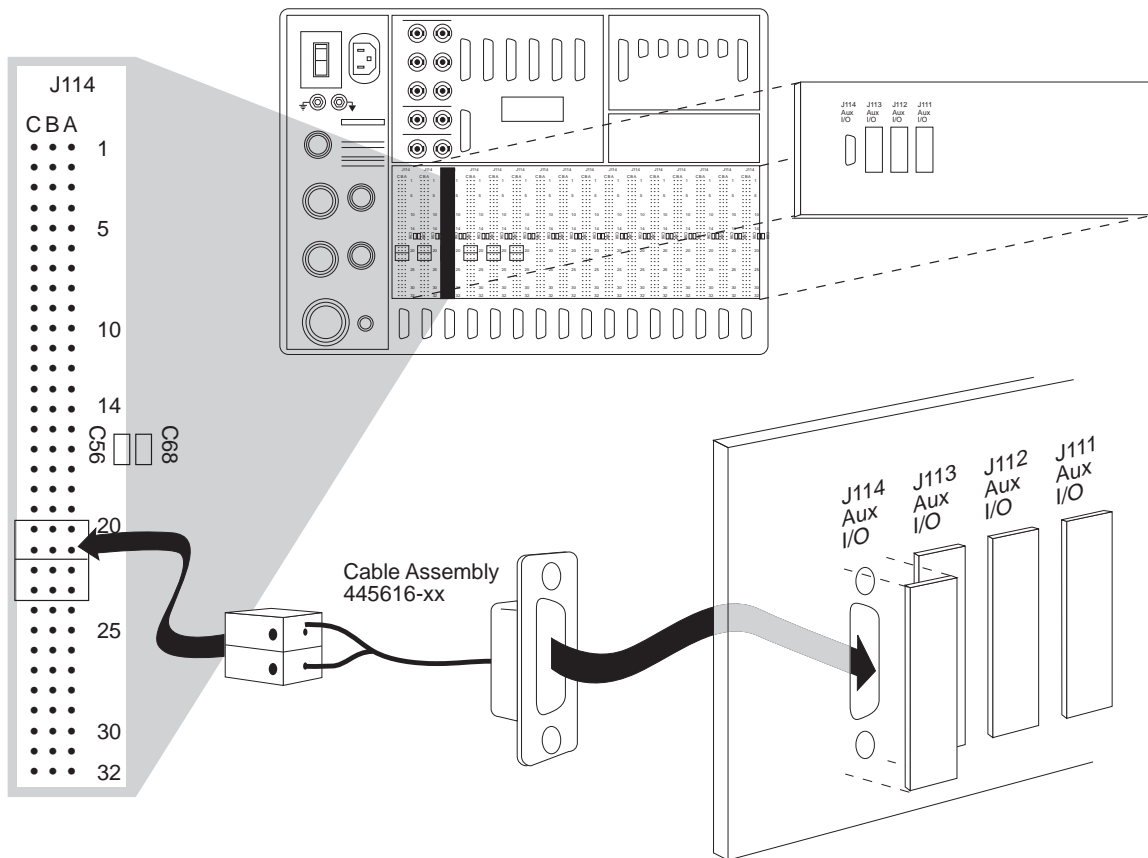
*Continued...*

**Installation (continued)**

8. Connect the Series 256 Servovalve. If you have a Series 257 Servovalve, refer to the 448.16C Valve Driver Package for cabling information.

Connect the cables as shown for a Series 256 Servovalve.

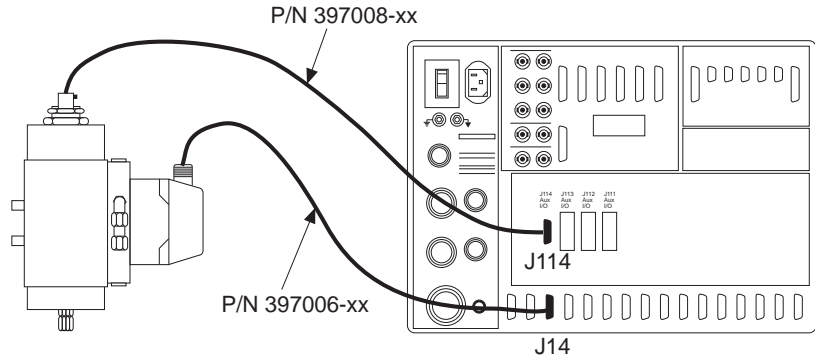

**Cable assembly**

Cable assembly 445616-xx connects between the digital controller back plane and the rear panel auxiliary I/O panel.

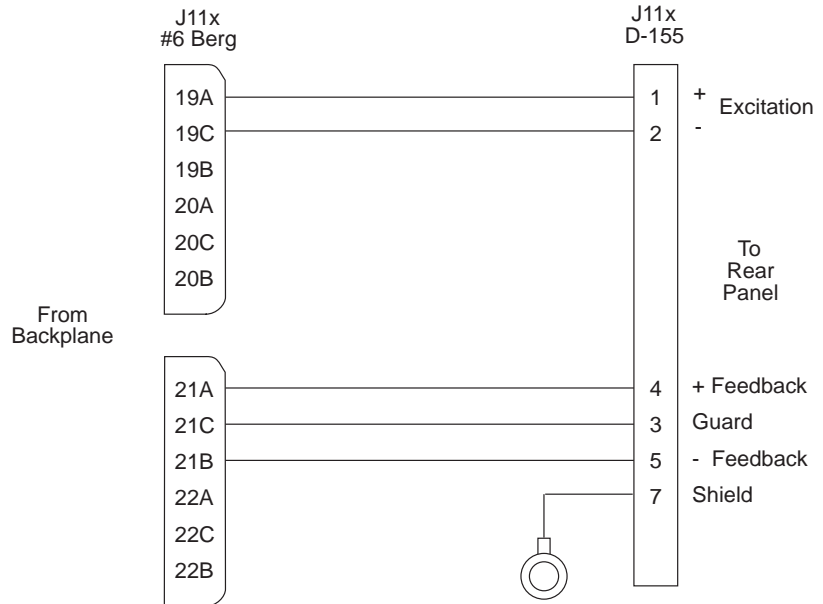

## Model 448.16C Power Driver Package

The Model 448.16C Power Driver package is required for the Series 257 Servovalve. The power driver generates the necessary power required by the servovalve. This package (part number 474396-xx) includes a Model 448.16C Power Driver and an interface cable. Two versions of this package are available:

- ◆ Part number 474396-01 includes the hardware to install the power driver into a vertical console or a table top console.
- ◆ Part number 474396-02 is the stand-alone version.

Refer to the Model 448.16C Power Driver product manual for information about the installation of the power driver chassis.

### Prerequisite

The Model 448.16C Power Driver package requires that the Model 490.17 Valve Driver package be installed.

### Cabling

The J4 connection is for an optional velocity sensor.

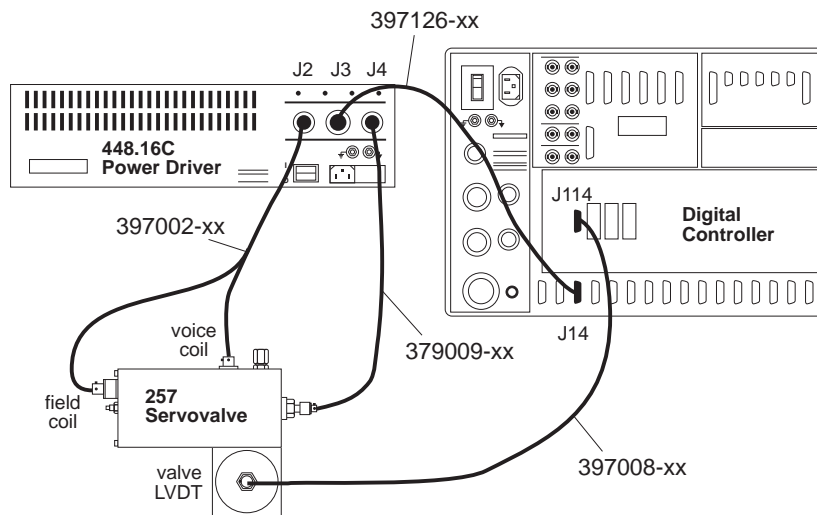

### Cable assemblies

The cables included with this package are standard MTS cables. The wiring diagrams are located in the MTS Cable Handbook.

## Multiple HSM Channels

---

The Multiple HSM Channel packages allow more than one HSM (hydraulic service manifold, also called actuator manifold) to be used with TestStar. Two packages are available:

- ◆ Part number 476137-xx supports multiple HSMs with on/off solenoids. Two configurations are available:
  - Part number 476137-01 is for a vertical console that needs a 8 foot (2.7 meter) cable.
  - Part number 476137-02 is for a stand alone chassis that needs a 3 foot (1 meter) cable.
- ◆ Part number 474391-xx supports multiple HSMs with proportional valves (also called electrical pressure reducing valves). Three configurations are available:
  - Part number 474391-01 supports a second HSM channel.
  - Part number 474391-02 adds a third HSM channel to the part number 474391-01 configuration.
  - Part number 474391-03 adds a forth HSM channel to the part number 474391-01 configuration.

PACKAGE	PARTS LIST	PART NUMBER
476137-01	Model 490.86 HSM Power Supply Cable Assembly (part number)	457995-01 476138-03
476137-02	Model 490.86 HSM Power Supply Cable Assembly	457995-01 476138-02
474391-01	Model 490.86 HSM Power Supply Cable Assembly Model 413.07 Service Manifold Interface Cable Assembly	457995-01 476138-03 413075-01 420757-01
474391-02	Model 413.07 Service Manifold Interface Cable Assembly	413075-01 420757-01
474391-03	Model 413.07 Service Manifold Interface Cable Assembly	413075-01 420757-01



## Installation

The installation procedures of the two Multiple HSM Channel packages are similar. Both packages require the Model 490.86 HSM Power Supply and the cable assembly part number 476138-xx.

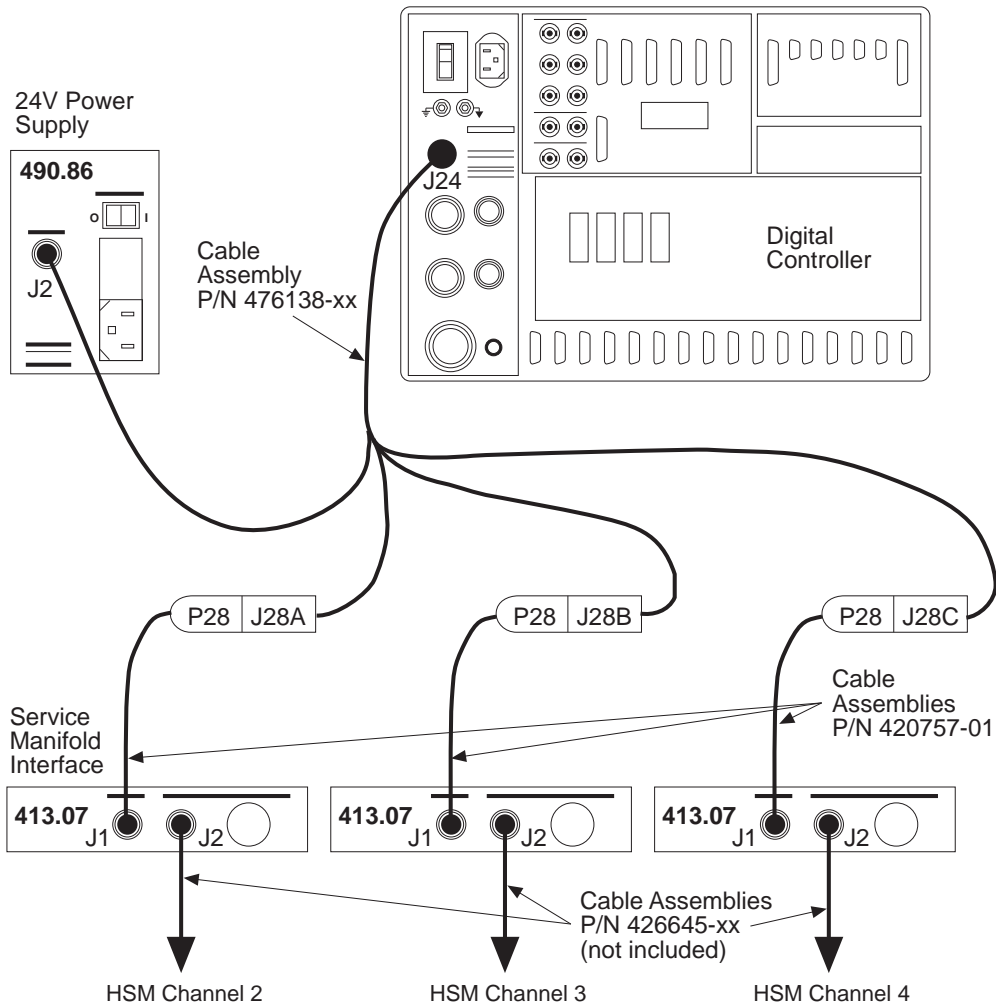

*Continued...*

**Installation (continued)**

Use the following procedure to install either the solenoid package or the proportional package.

1. Connect P24 of the cable assembly part number 476138-xx to J24 of the digital controller.
  2. Position the Model 490.86 HSM Power Supply within reach of P2 of the cable assembly part number 476138-xx. Connect P2 to the power supply.
  3. Perform step 3A if you are installing the solenoid package. Perform steps 3B - 3E if you are installing the proportional package.
- H Connect J28A of the cable assembly part number 476138-xx to the HSM designated as channel 2. For additional channels, connect J28B to the HSM designated as channel 3 and J28C the HSM designated as channel 4.
- I Connect J28A of the cable assembly part number 476138-xx to P28 of the extension cable assembly part number 420757-01. For additional channels, connect J28B to an extension cable for a third channel and connect J28C to an extension cable for a fourth channel.
- J Position each Model 413.07 Service Manifold Interface within reach of P1 of the cable assembly part number 420757-01. The Service Manifold Interface can be mounted in the rear of a console. Connect P1 of the cable to J1 of the Service Manifold Interface.
- K Connect P2 of each cable assembly part number 426645-xx to J2 of each Service Manifold Interface. The cable assembly is not included with the package.
- L Connect P1 of each cable assembly part number 426645-xx to the appropriate HSM. Each cable assembly is associated with one of the J28 connectors
- J28AHSM Channel 2
  - J28B HSM Channel 3
  - J28CHSM Channel 4
-

## Cable assemblies

The following show the wiring of the cable assemblies included with the multiple HSM channel packages.

Cable assembly 476138-xx is used with both HSM packages.

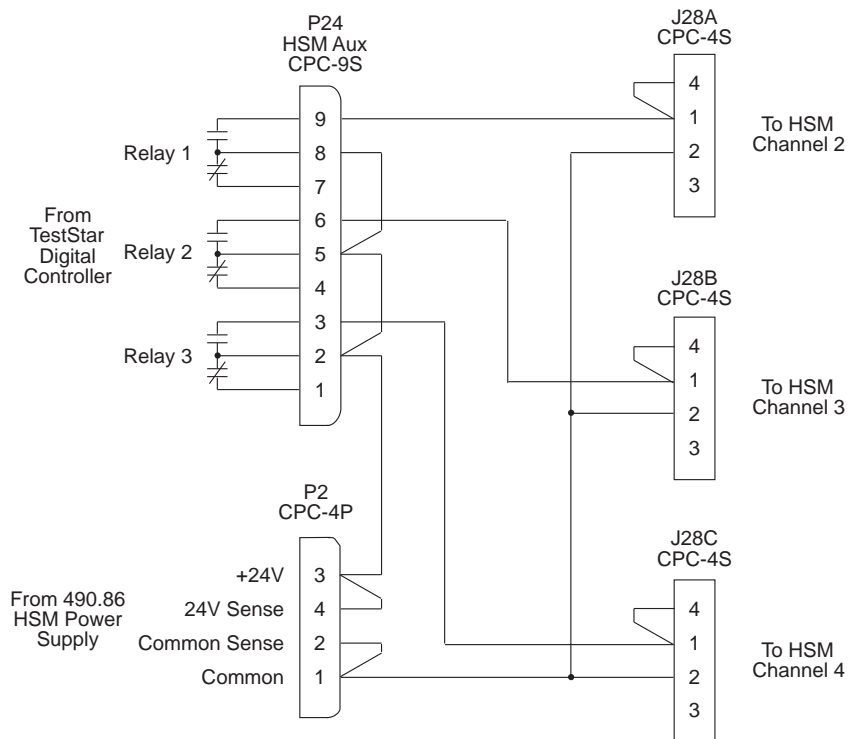

Cable assembly 420757-xx is used only with the proportional package.

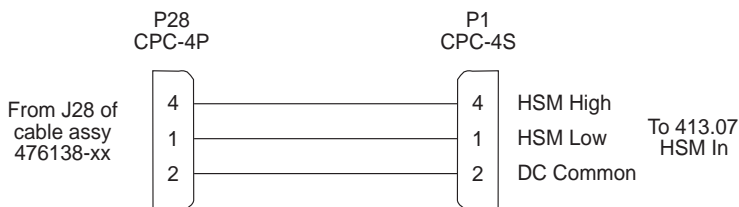

## Forward Loop Filter Package

The Forward Loop Filter package (part number 477605-01) includes a daughter board for the Model 490.14 Valve Driver module. The forward loop filter reduces load frame resonance on systems with heavy grips.

**Note** *The forward loop filter is included with the standard Model 490.17 Valve Driver module.*

### Installation

Installing the forward loop filter involves configuring a soldered jumper and mounting a daughter board to the valve driver module.

1. Remove the Model 490.14 Valve Driver from the digital controller. Loosen the screws that secure the module to the digital controller and pull the module out.
2. Locate jumper X9. This jumper is a wire soldered to the circuit board. Unsolder the wire jumper from pins 1 and 2, then solder the jumper between pins 2 and 3. This enables the filter.
3. The filter daughter board has pins that mate with connectors J2 and J3 of the valve driver circuit board. Align the pins with the connectors and carefully seat the pins into the connectors.
4. Secure the filter daughter board to the valve driver circuit card with the three screws, nuts, and stand-offs included with the package.
5. Install the valve driver module into the digital controller.
6. Perform the initial setup and adjustment procedure.

Be sure to configure jumper X9 before installing the daughter board.

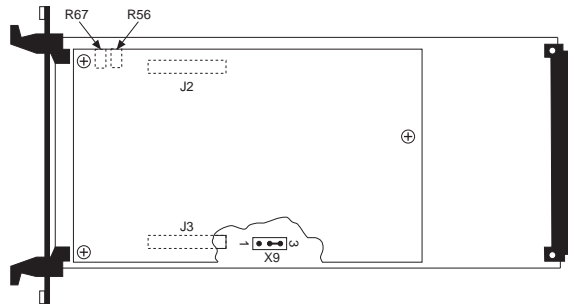

## Initial setup

Before you can adjust the filter circuit, the following must be true:

- ◆ The entire TestStar *system must be completely installed* (hardware, software, initial software settings, etc.).
- ◆ The filter must be mounted on the 490.14 Valve Driver module.
- ◆ Jumper X9 must be set to pin 2 and 3.
- ◆ No specimen should be installed.
- ◆ Lock the load unit crosshead.
- ◆ Install the valve driver on a 3U extender card. (MTS p/n 119506-48).
- ◆ You should also be familiar with the general operation of TestStar (such as selecting a control mode, installing a specimen, running a simple test).

## Adjustment procedure

The forward loop filter adjustment compensates for system resonance when heavy masses are installed in the load path (such as large grips). The filter should be adjusted when the system is installed and should not need readjustment.

The idea of is to adjust the potentiometers as high as possible without going unstable.

- ◆ The higher the adjustment, the higher the cutoff frequency of the filter. This provides a higher system bandwidth.
- ◆ In general, the softer the specimen, the lower the resonate point of the system.

This procedure attempts to place the filter notch over the system resonate point that improves system stability.

1. Be sure the Initial setup requirements are true.
2. Adjust both R67 and R56 fully counter clockwise.
3. Apply hydraulic pressure to the system.
4. Select force control for the load unit control panel (Pod).

*Continued...*

**Adjustment procedure  
(continued)**

5. Press the Actuator Positioning Control (APC) switch on the load unit control panel to enable the APC.
6. Open the Tune PIDF window (Adjust menu) for the LUC control mode. Adjust the proportional gain as high as possible without going unstable.
7. Adjust both R67 and R56 clockwise to the first mark; then adjust them to next mark; continue this progression until the system goes unstable. Then readjust both R67 and R56 back to the last stable settings. (These adjustments usually end up with the potentiometers set at three-quarters clockwise.)

**Note** *There may be situations where tuning the forward loop filter does not create instability. In these cases, adjust both controls fully counter clockwise.*

---

8. Tune the proportional gain (Tune PIDF window) according to normal procedures. See Chapter 9 in the Reference manual for guidelines.
  9. If the system is stable, you are done.
  10. If the system is unstable, then adjust R67 and R56 clockwise to stabilize the system.
  11. Shut down the system hydraulics and electrical power. Remove the extension board and install the Valve Driver in the appropriate module location.
-

## ±15 Volt Power Package

---

The ±15 Volt Power package (part number 474392-01) includes the required hardware to add a rear panel connector that provides ±15 volts for use with external devices.

### Limitation

The total current draw permitted from the digital controller ±15 volt power supply is 500 mA.

### Uses

The ±15 Volt Power package is designed to support two hardware applications. Other hardware may use the connector provided the power limitation is observed.

- ◆ The Temposonics™ linear displacement transducer system is compatible with the power limitation. Use cable assembly 467265-xx for a Temposonics transducer.
- ◆ The Series 633 Extensometer is compatible with the power limitation. Use cable assembly 397044-xx for a Series 633 Extensometer.

### Installation

The cable assembly is long enough to be installed in any one of the rear panel connector locations J111 through J114. The following procedure describes the installation for the J111 location.

1. Remove the Auxiliary I/O panel from the digital controller rear panel. The Auxiliary I/O panel contains connector locations marked J111 through J114 Aux I/O.
2. Remove the small panel from the J111 connector location of the auxiliary I/O panel. If this connector location is used, select an unused connector location (J112 - J114).
3. Install the 15-pin connector in the selected connector location on the auxiliary I/O panel with the hardware included. Also, secure the ground lug of the cable assembly to the panel along with the connector.

*Continued...*

**Installation (continued)**

4. Install the back plane connection of cable assembly 467268-01 to the pins of back plane connector J110. The cable assembly can be connected to back plane connectors J101 through J110. Do not connect to J111 through J114 since this could reduce the power available for the associated valve driver.

The dot on the connector corresponds with the back plane pin 16A. The connector covers pins 16A, 17A, 18A, 16B, 17B, and 18B.

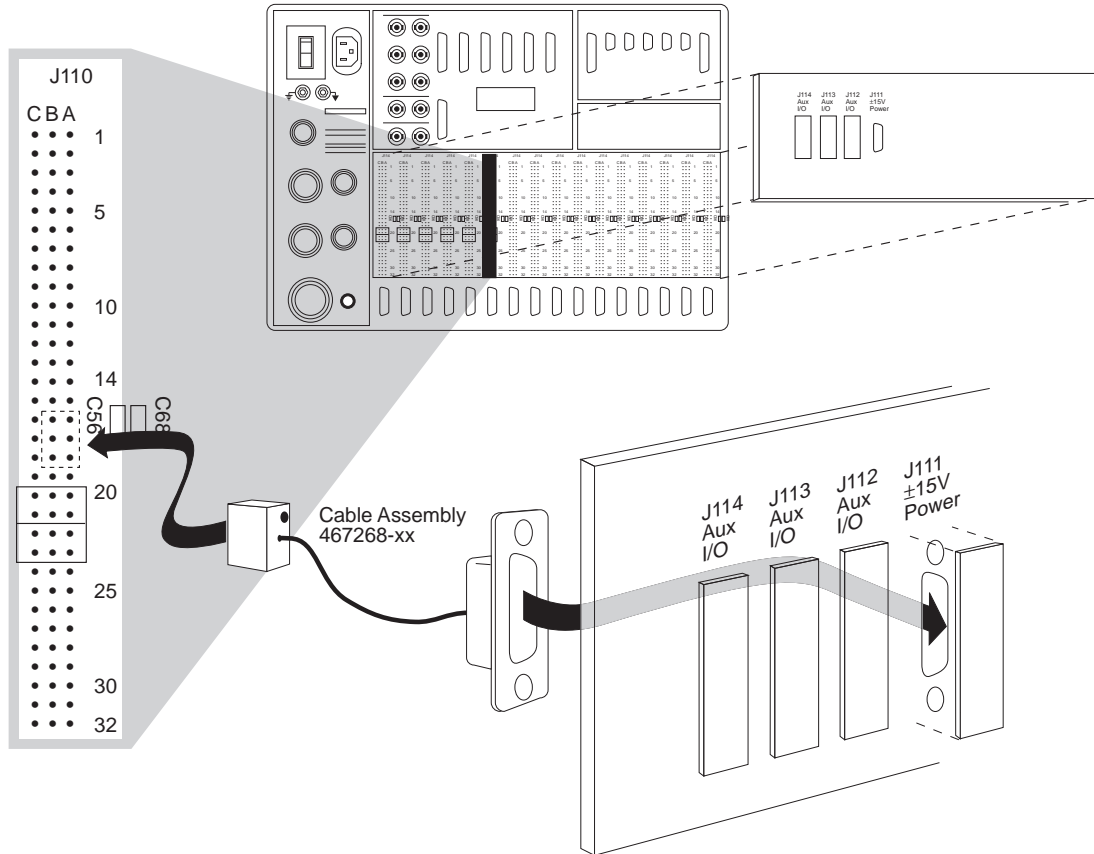

5. Reinstall the auxiliary I/O panel.
6. Apply the label Aux ±15V Power (part number 472497-01) above the selected connector location.



## Cable assembly

This shows the rear panel connections for the  $\pm 15V$  Power connector.

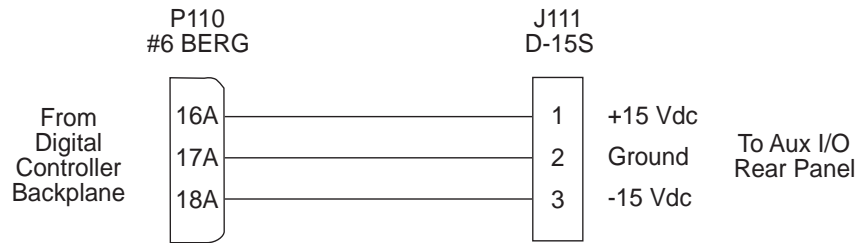

## ADT Support Package

---

The ADT Support package (part number 474394-01) provides information to modify a Model 490.21 DC Conditioner for use with an angular displacement transducer.

### CAUTION

**The DC Conditioner module contains static-sensitive components. Improper handling of the module can cause component damage.**

Installation of the ADT Support package requires the post amplifier daughter board to be removed and soldering of components. Be sure the person performing the installation of this package is qualified to perform circuit modifications.

### Installation

Perform the following procedure to modify a Model 490.21 DC Conditioner for use with an ADT. Be sure to use proper handling precautions during this procedure.

1. Remove the post amplifier daughter board from the dc conditioner. The daughter board is mounted to the main board with two screws and standoffs. The daughter board also has pins that seat into connectors J10 and J11 on the main board.
2. Identify the resistor R2 on the post amplifier daughter board. Replace the 100k R2 resistor with the 20k resistor (part number 114272-22) supplied with the package.
3. Identify the resistor pack Z2 on the main circuit card. The resistor pack looks like an IC chip. Solder the 10k resistor (part number 113407-44) across pins 2 and 15 of the resistor pack.
4. Install the post amplifier daughter board onto the main board. Align the pins of the daughter board with the J10 and J11 connectors on the main board. Seat the pins into the connectors.

Secure the daughter board to the main board with the standoffs and screws removed in step 1.

5. Replace the front panel label with the new label (490.21S DC Cond).

*Continued...*

**Installation (continued)**

The post amplifier daughter board is installed with the component side toward the main board.

Add the 10k resistor to the top of the resistor pack (which looks like an IC).

Do not add the 10k resistor to the non-component side because of the limited clearance between the plug-in modules.

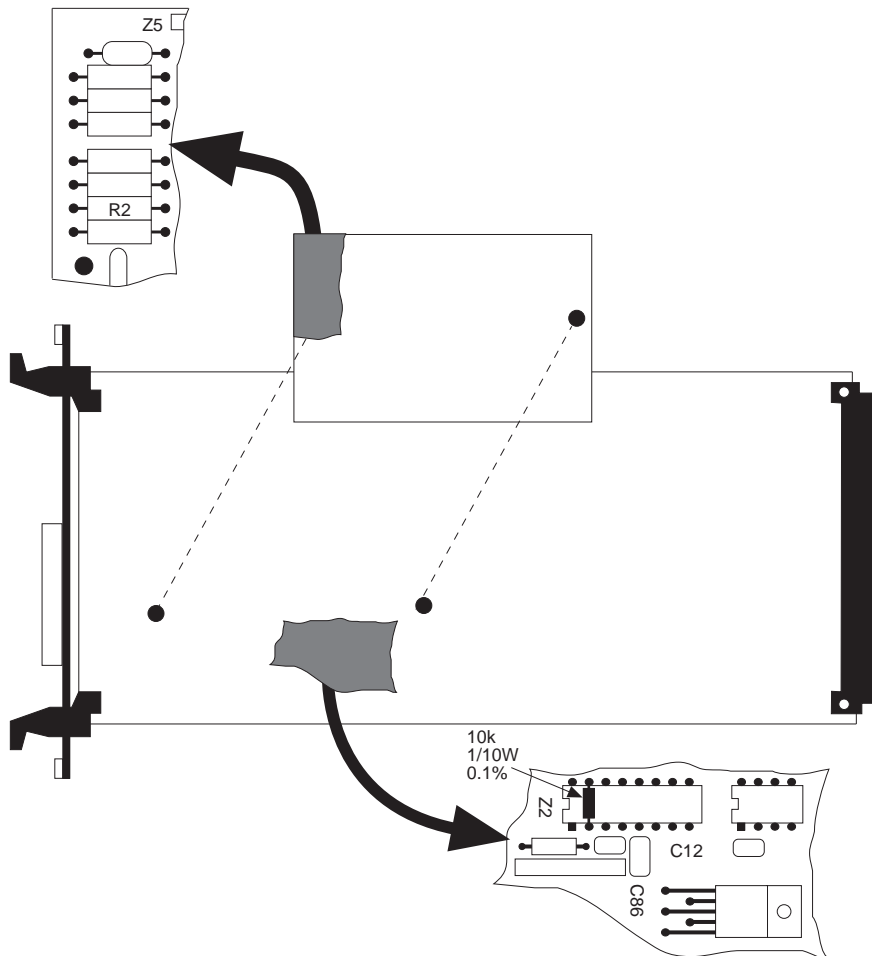
**Sensor cartridge**

When a DC conditioner has been modified for use with an ATD, shunt calibration is not used and a sensor cartridge is not needed. However, a sensor cartridge should be installed for maximum ESD protection.

## 115 Vac Solenoid Interface

---

The 115 Vac solenoid package (part number 474390-xx) allows you to control hydraulic equipment that uses 115 Vac solenoids. The kit contains an interface module that attaches to the rear panel of the digital controller. Two configurations are available:

- ◆ Part number 474390-01 provides the 115 Vac solenoid interface module with a USA power cord that plugs into a power strip.
- ◆ Part number 474390-02 provides the 115 Vac solenoid interface module with a modified power cord that plugs into a J25 of the HPS system cable. The HPS system cable must be part number 397043-xx (or equivalent).
- ◆ Be sure your hydraulic interface requires this hardware package. See Appendix E for information about different hydraulic interface cabling. This appendix describes the cabling interface with specific MTS load units.

---

### Installation

The 115 Vac solenoid interface module mounts on the rear panel of the digital controller. Perform the following to install the interface module:

1. Position the 115 Vac solenoid interface module as shown in the diagram. Note the six screws that will mount the module and remove them.
2. Position the module as shown in the diagram and secure it with the six screws removed in step 1.
3. Plug cables P28 and P29 into the corresponding connectors on the digital controller rear panel.

*Continued...*

Installation (continued)

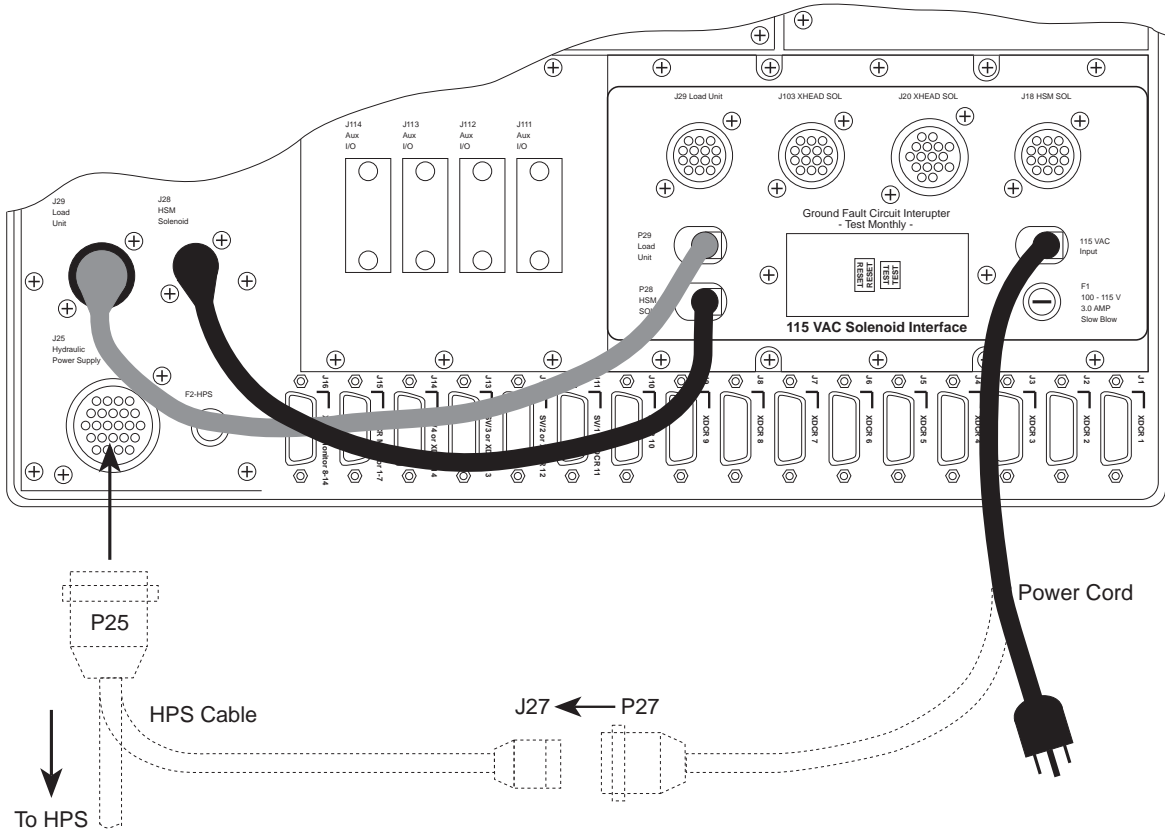

The 115 Vac Solenoid Interface mounts on the rear panel of the digital controller using existing screws.

Continued...

Installation *(continued)*

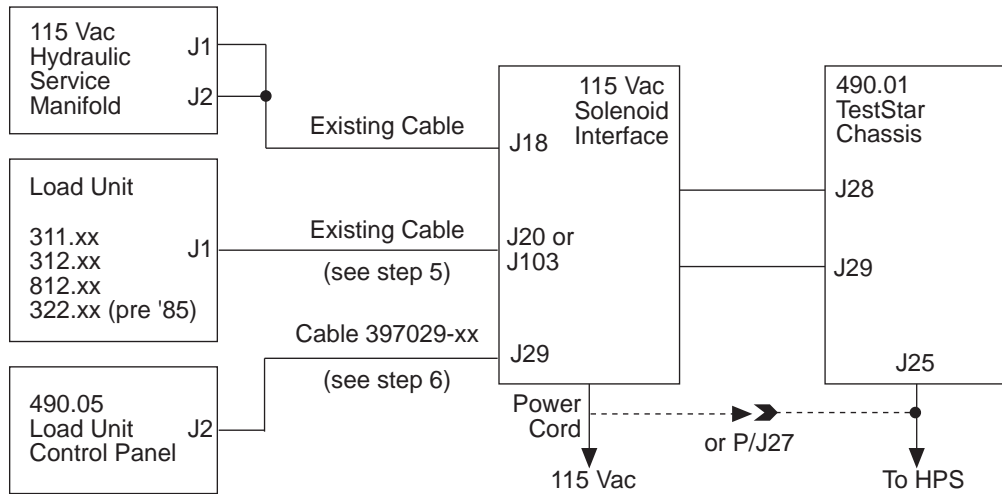

4. Connect the existing cable from the hydraulic service manifold into J18 of the solenoid interface.
5. Connect the existing cable from the load unit crosshead controls to either J20 or J103 (which ever fits).

If the system has a load unit with a DC solenoid, DO NOT plug it into J20 or J103 of the 115 VAC Solenoid Interface module.

6. If a load unit with a 115 Vac solenoid is plugged into J20 or J103 of the 115 VAC Solenoid Interface module, connect cable assembly 397029-xx between the load unit control panel (LUCP) and J29 of the solenoid interface module.

If the system has a 318 or similar load unit without a crosshead solenoid, plug cable P/N 397028-xx into J29 of the TestStar chassis. In this case, plug the short P29 cable from the solenoid interface module into J 29 of the same module (for storage).

7. Plug the power cord into a power strip or into the system HPS cable (part number 397043-xx).

## Wiring Diagram

The wiring diagram shows the internal wiring of the 115 Vac solenoid interface module. (Ref. wiring assembly 477417-01)

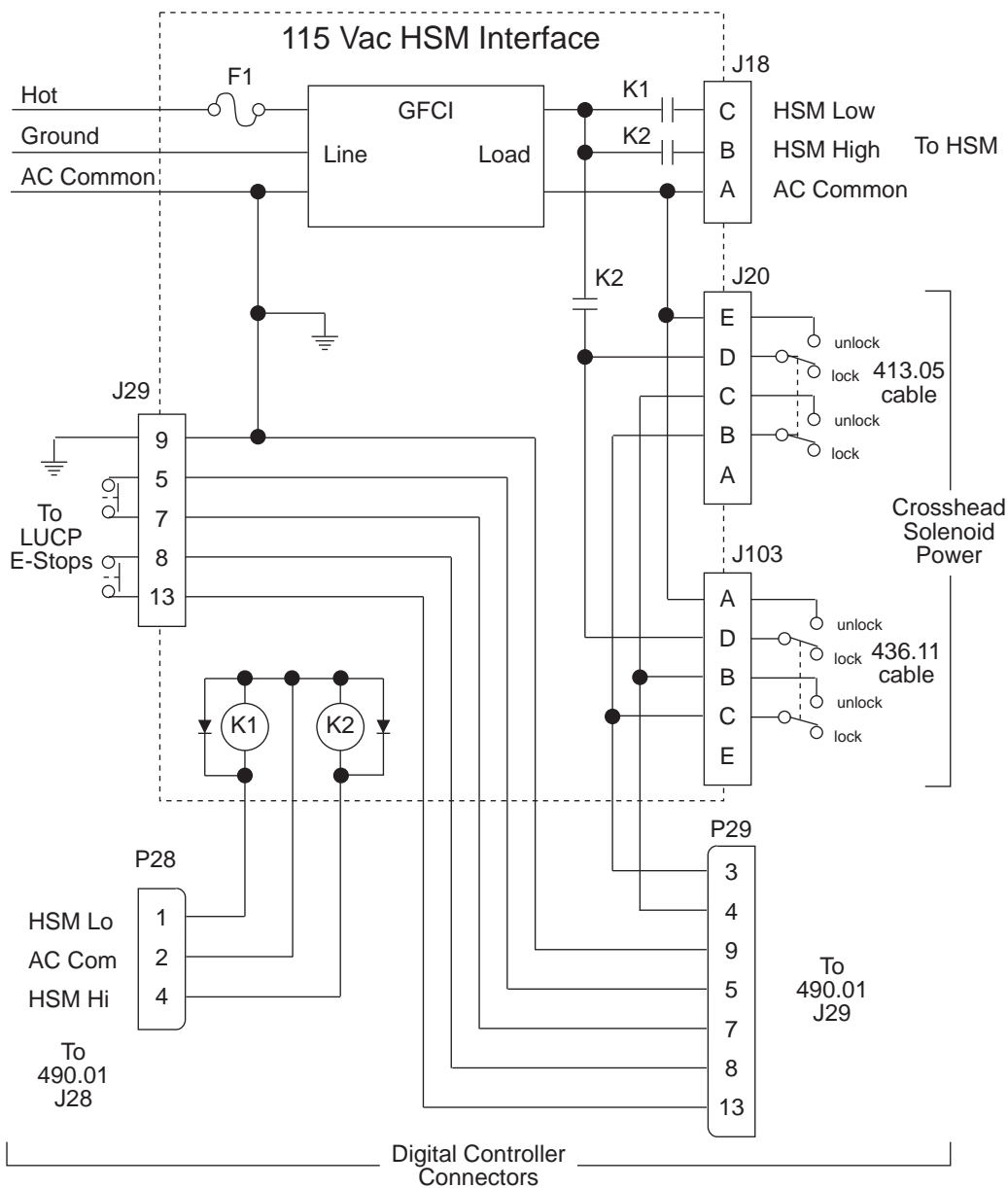

## Extended Analog I/O

The Extended Analog I/O package (part number 491089-02) adds sixteen external analog inputs to TestStar.

**Note** See J63/J64 in Chapter 3 to make a cable for your needs.

See Chapter 10 to use the additional analog inputs.

This hardware package involves installing a second 490.40 Analog I/O module and replacing two of the connector panels on the rear of the chassis.

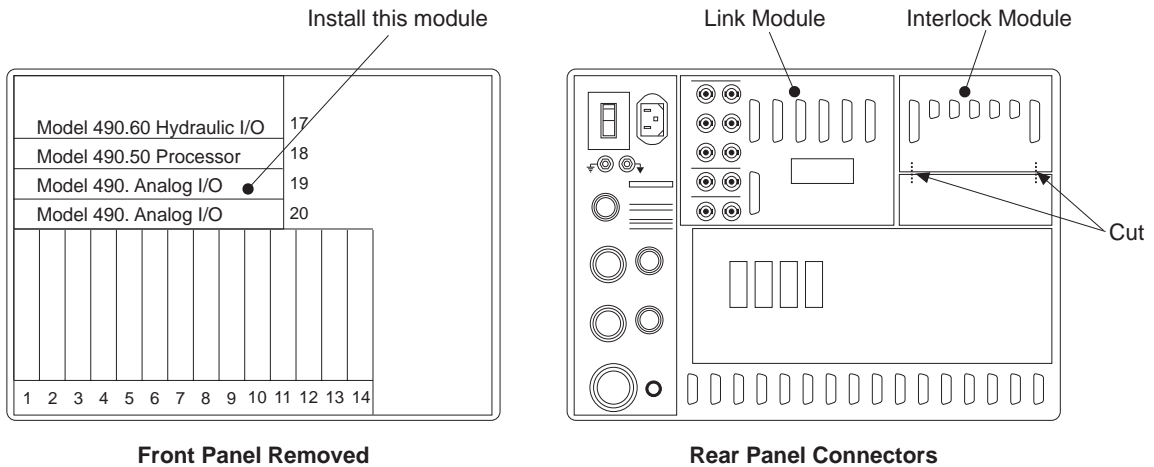

### Step 1 Install the 490.40 Analog I/O module

1. Remove the front panel of the TestStar chassis.
2. Remove the blank panel at slot 19 (above the other Model 490.40 Analog I/O module). The blank panel is no longer needed.
3. Plug the new Model 490.40 Analog I/O module into slot 19.
4. Install the front panel to the TestStar chassis.



**Step 2 Replace the link module**

The link module is a panel of connectors located on the rear of the TestStar chassis. Compare the new module with the one installed.

- ◆ Older versions of the link module have connectors J52 and J53.
  - ◆ Newer versions of the link module has J63 and J64 labels, but no connectors.
  - ◆ The new link module includes connectors for J63 and J64.
1. Remove the screws that secure the link module to the rear panel.
  2. Pull the module out of the chassis. The pins of each connector plug directly into the back plane of the chassis.
  3. Align the pins of the new link module with the back plane sockets and push the module in.
  4. Secure the new link module to the rear panel with the screws removed in Step 1.
- 

**Step 3 Replace the interlock module.**

The interlock module is a panel of connectors located on the rear of the TestStar chassis. Compare the new module with the one installed.

- ◆ Older versions of the interlock module are smaller than the new one.
  - ◆ Newer versions of the interlock module look the same as the new one. Replace the module to ensure the most recent revision is installed.
1. Remove the screws that secure the interlock module to the rear panel. TestStar chassis manufactured before 1994 have an additional panel below the interlock module to remove.
  2. Pull the module out of the chassis. The pins of each connector plug directly into the back plane of the chassis.
  3. Use the nibbling tool to cut the bar between the two openings.
  4. Align the pins of the new interlock module with the back plane sockets and push the module in.
  5. Secure the new interlock module to the rear panel with the screws removed in Step 1.
-

## Production QC

---

The Production QC hardware package supports a software option for the Dynamic Characterization and Static Deflection application. The Production QC feature includes both hardware and software. It is designed to test materials and components in a production environment.

---

### Prerequisites

You must have the Model 790.31 Dynamic Characterization or the Model 790.33 Static Deflection application and the Model 790.35 Production QC software application installed. You also need a test procedure designed to make use of the Production QC hardware package.

---

### How it works

The production QC hardware package includes a light curtain that is attached to a load unit. The light curtain monitors the crush zone of the load unit. The light curtain can detect objects that penetrate the infrared zone between two vertical bars (one is the infrared emitter and the other is the infrared detector).

---

### For example

The Dynamic Characterization software application produces the test for the specimen. The Production QC software application provides the interface between the hardware package and the Dynamic Characterization software application. A typical sequence of operation is as follows:

- ◆ The operator presses both Start buttons on the Production QC control panel. This starts the dynamic characterization test and enables the light curtain.
  - ◆ While the test is running, any object breaking the plain of the light curtain stops the test and causes a hydraulic interlock.
  - ◆ When the test is complete, the test results are displayed on the control panel (and recorded in a data file).
  - ◆ The light curtain is disabled so the operator can remove the specimen and install another one.
-

## Installation

The hardware installation involves mounting the control panel to the platen of the load unit, the light curtain to the crosshead, and the interface box to a convenient location. These components are usually fitted and installed at MTS Systems Corp. and not described here.

In the field, software installation and cabling (see below) may be needed. The software is installed using the Additional Application Installation mode in Setup program.

## Cabling

This figure shows how the production QC components are connected.

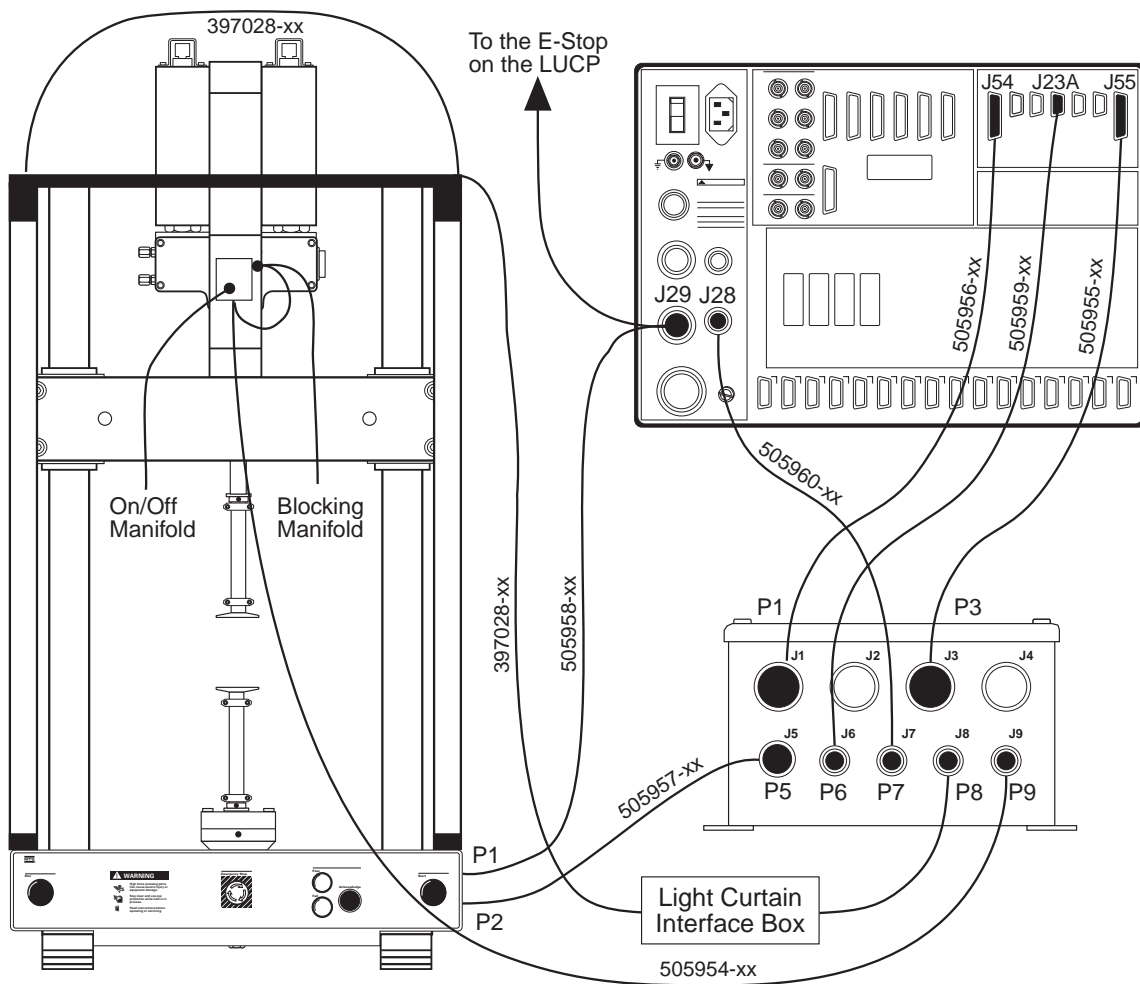

## Controls and indicators

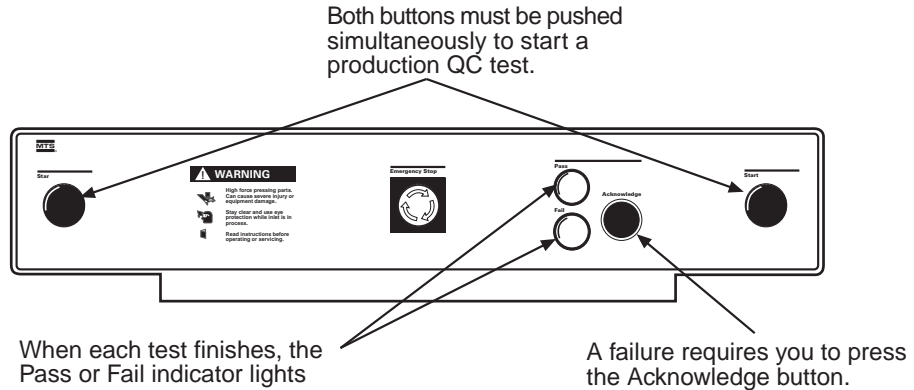

## Input channels

You must know which device is connected to each channel. See the “Hardware requirements”.

### Part ID and process start

The input channels can be multiplexed to identify different parts (specimens). The combination of input states (high or low) and the number of channels allow the following:

- ◆ 1 channel can identify 2 parts
- ◆ 2 channels can identify 4 parts
- ◆ 3 channels can identify 8 parts

Each Production QC process specifies the input channel pattern that will start the process. Otherwise, the process is ignored. See “Using the window” for an example.

### Acknowledge signal

If a test does not pass, a Limit Violation Notice is displayed in a small dialog box. Press OK to acknowledge the failure or warning. The Acknowledge signal duplicates this function along with the F1 switch on the load unit control panel.

*Continued...*

The Elastomer QC Interface control panel. can issue this signal when the operator presses the Acknowledge button. This is done to acknowledge that the Fail indicator is lit (see “Output channels”).

## Output channels

You must know which device is connected to each channel. See the Hardware requirements. The output channels are set to the opposite state when the process begin. *For example*, an output channel may be set to turn on a pass indicator; so the indicator is turned off at the beginning of the process.

### Pass/Fail/Warn

Each output channel can be set to:

- ◆ Pass, High
- ◆ Pass, Low
- ◆ Fail, High
- ◆ Fail, Low
- ◆ Warn, High\*
- ◆ Warn, Low\*
- ◆ Warn/Fail, High\*
- ◆ Warn/Fail Low\*

\* The warn function is available only with the Model 790.31 Dynamic Characterization application.

### Light pass/fail

When using the Elastomer QC Interface control panel, output channel 7 lights the Pass indicator and output channel 8 lights the Fail indicator. When the fail indicator lights, the operator must press the acknowledge pushbutton so the process can continue (see “Input channels”).

### Load washer

The 1000 Hz systems use load washers. While this may be a rare application for QC systems, you should be aware that this application reserves output channels 1 - 5 to select a range for the load washer.

### Light curtain

A light curtain is an optional device that inhibits operation while a specimen is being installed or removed from the load unit. If you use this device, output channel 6 is reserved to enable and disable the light curtain.





# *TestStar™ II*

Control System

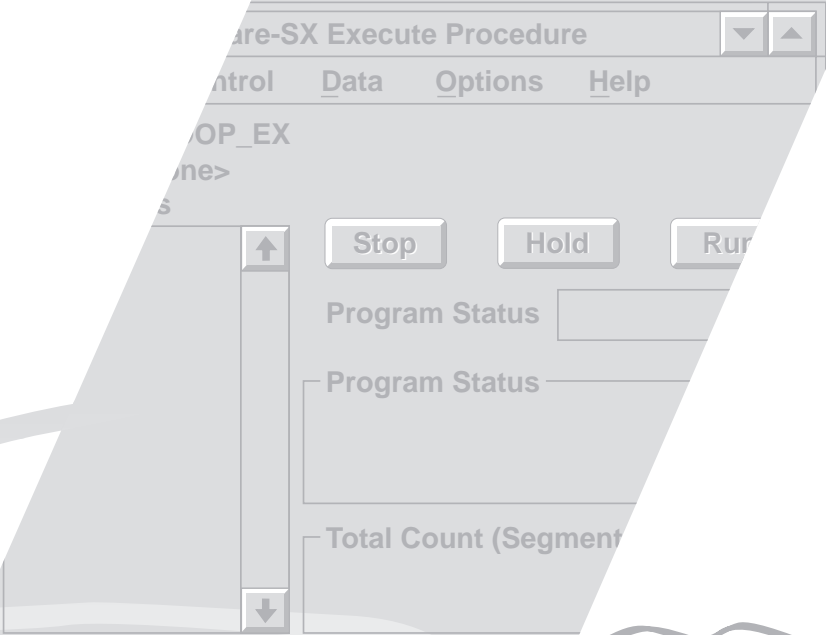
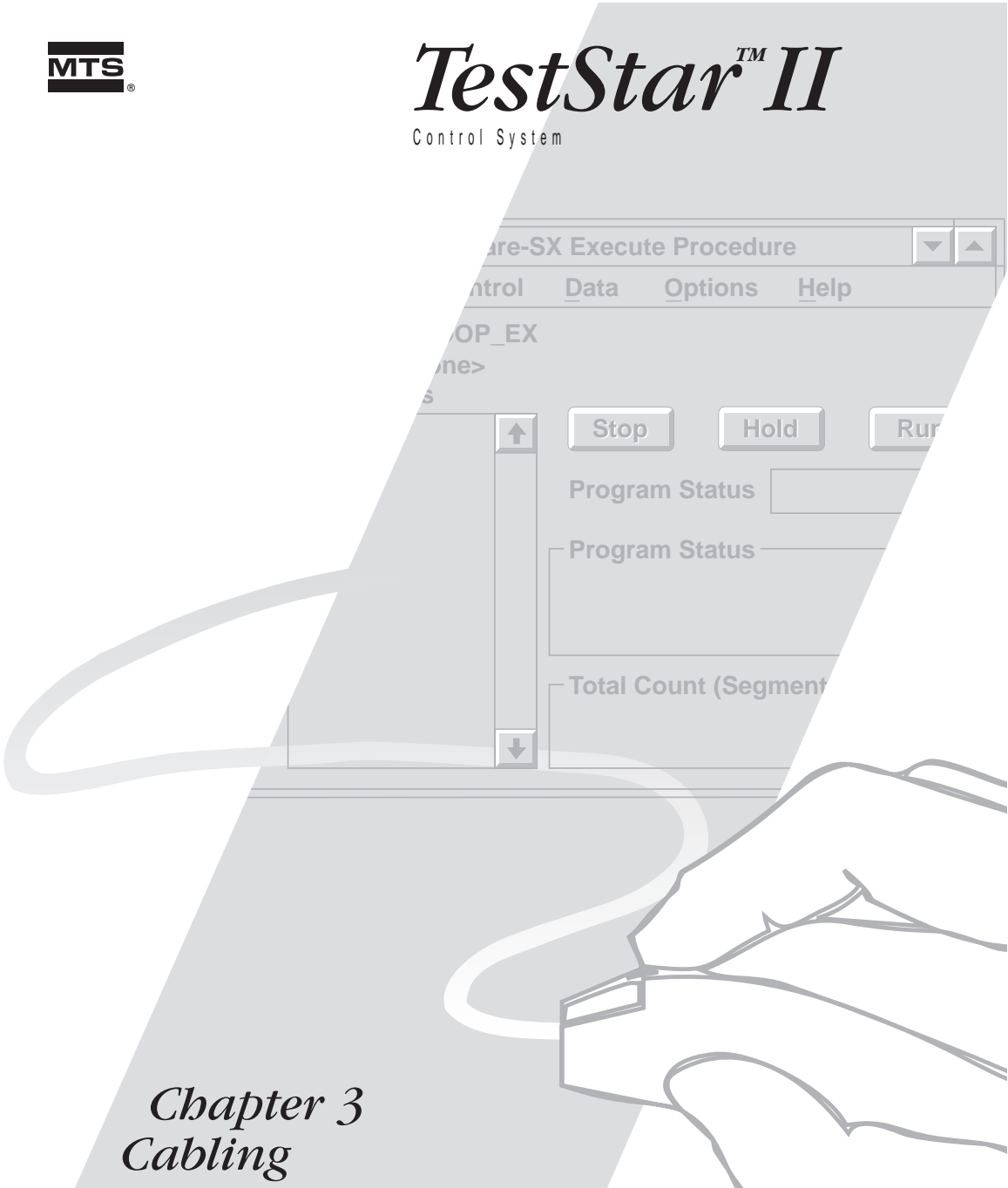

## *Chapter 3 Cabling*

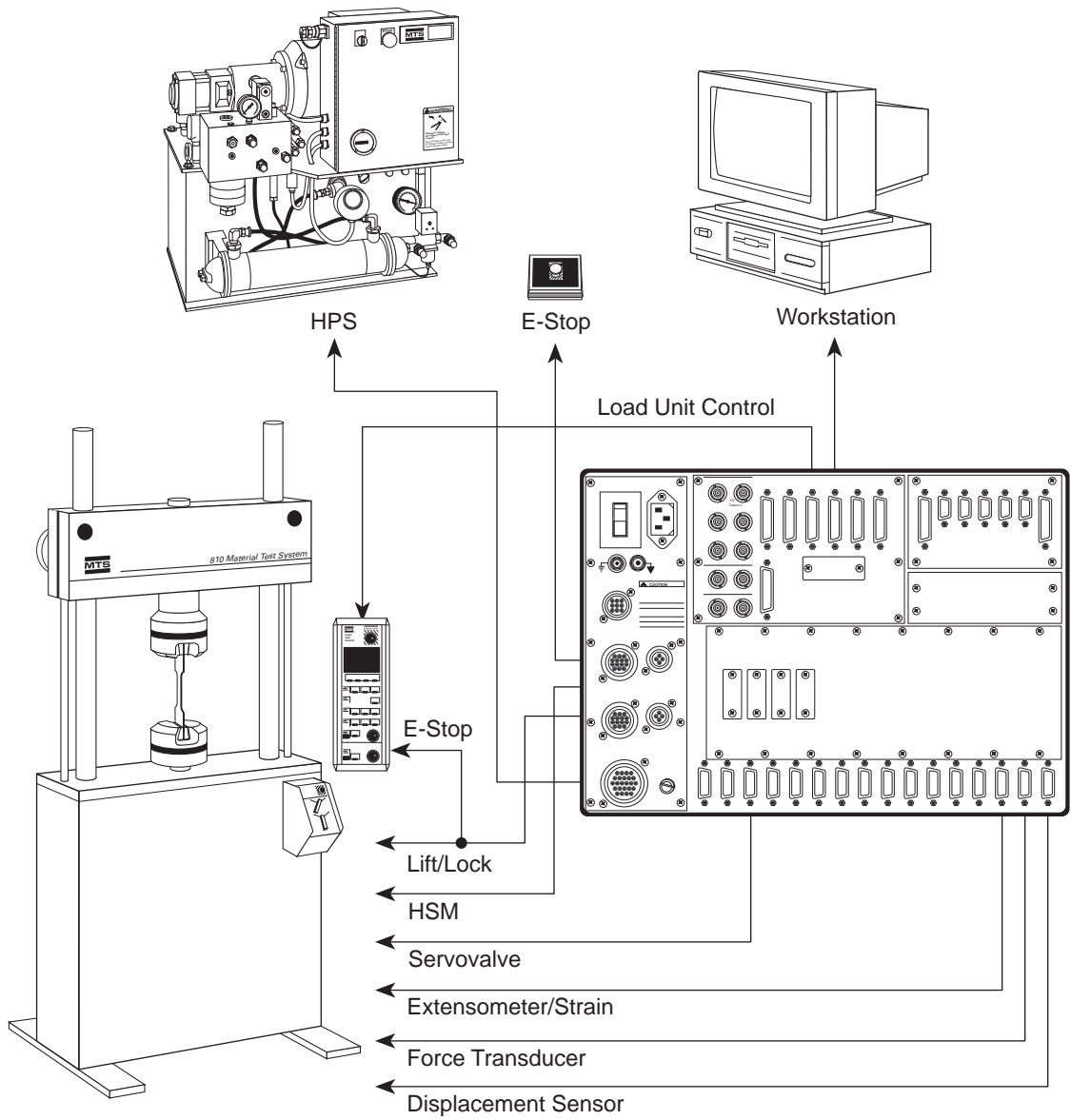



## Chapter 3

# Cabling

---

This section describes the TestStar cabling and rear panel connectors.

<b>Contents</b>	Typical Cabling	115
	Cable Assembly Numbers	116
	CE Compliant Cabling	117
	Rear Panel Connectors and Cabling	119
	Panel 1 Connectors	120
	J20 HSM Proportional	121
	J24 HSM Auxiliary	122
	J25 Hydraulic Power Supply	123
	J28 HSM Solenoid	124
	J29 Load Unit	125
	J30 Emergency Stop	126
	Panel 2 Connectors	127
	J41A, J41B Readout	128
	J42 External Data Inputs 1-8	129
	J50 Load Unit Link	130
	J51 Workstation Link	131
	J63/J64 Extended Analog I/O	132
	J71 through J80 BNC Connectors	133

*Continued...*

Panel 3 Connectors	134
J23A, J23B Hyd Intlk 1 and 2	135
J43 Prgm Intlk	136
J54 Digital Input	138
J55 Digital Output	140
J61 Aux I/O	142
Panel 4 Connectors	143
J1 - J10 Sensor Connections	144
J11 - J14 Sensor/Servo Valve Connections	146
J15, J16 Sensor Monitor Connections	148
Auxiliary I/O Panel	150

---

# Typical Cabling

The cabling shown includes the page numbers for the associated connectors.

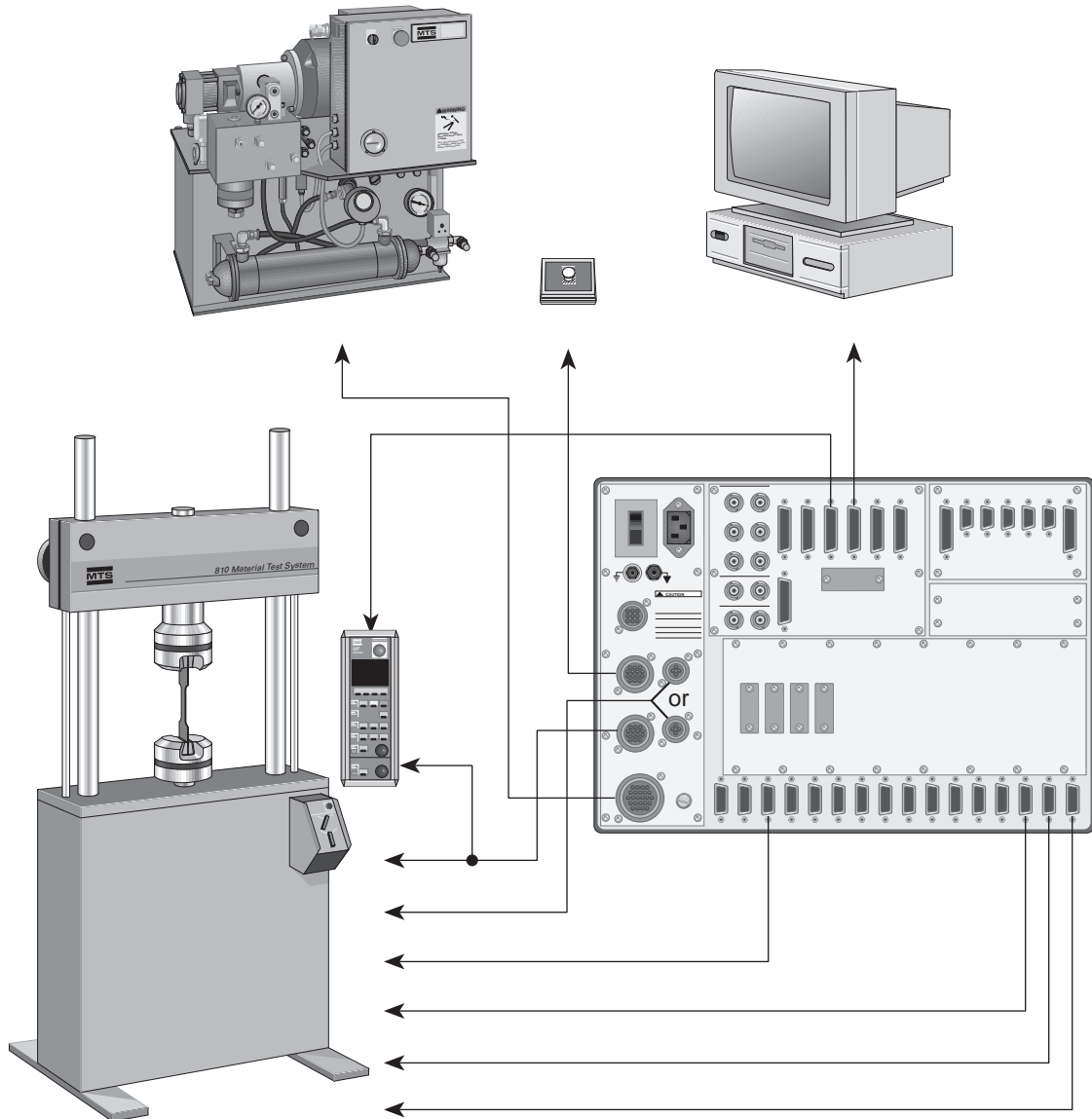

# Cable Assembly Numbers

CABLE DESCRIPTION	ASSEMBLY NUMBER	REAR PANEL	JUMPER PLUG
Force Transducer	397011-xx	J1 - J14	
Extensometer/Strain	397018-xx	J1 - J14	
Displacement/LVDT	397020-xx	J1 - J14	
ADT	471590-xx	J1 - J14	
Servo valve 252.xx single	397006-xx	J11 - J14	
Servo valve 252.xx dual	397007-xx	J11 - J14	
Servo valve 256.xx Valve LVDT	397006-xx 397008-xx	J11 - J14	
Servo valve 257.xx Valve LVDT 490.17 to 448.16C Velocity XDCR (opt)	397002-xx 397008-xx 397126-xx 397009-xx	J11 - J14	
System ground (console)	054023-xx		
System ground (floor standing)	397092-xx	gnd lug	
E-stop 318 Load Unit w/crosshead locks & LUCP	397185-xx	J29	397198-01
E-stop 318 Load Unit wo/crosshead locks & LUCP	397186-xx	J29	397198-01
E-stop 490.05 Load Unit Control Panel only	397187-xx	J29	397198-01
E-stop 490 Workstation	397188-xx	J30	397196-01
HPS 24 Vdc	397087-xx	J25	397199-01
HPS 115 Vac	397088-xx	J25	397199-01
HSM Proportional 298.12	397026-xx	J20	
HSM 290.xx on/off	397053-xx	J28	
HSM 290.xx/294.xx high/low	397055-xx	J28	
HSM 298.11 on/off	397081-xx	J28	
Test Enclosure Interlock	407836-xx	J23	397194-01
Hydraulic Interlock	per system	J23	397194-01
Program Interlock	per system	J43	397195-01
Auxiliary I/O	per system	J61	397193-01
Load Unit Control Panel Link	397037-xx	J50	397127-01
Workstation Link	397041-xx	J51	
-xx specifies cable length. -01 through -09 represent 10 feet through 50 feet in 5-foot increments.			

# CE Compliant Cabling

---

As of January 1, 1996, CE compliant cabling is required for all systems shipped to Europe. All cabling specifications in this chapter conform to the European CE requirements.

---

## Cable fabrication

When you construct an CE compliant cable you need the following:

- ◆ a metal body connector (tin plating is preferred)
  - ◆ a metal or metalized plastic back shell
  - ◆ cable with an overall foil or braided shield
  - ◆ Connect the overall shield to the metalized backshell at the TestStar chassis end.
  - ◆ An inline filter may also be required to meet CE compliance on cabling to some TestStar I/O connectors. See the CE compliant cable filtering topic in this section.
- 

## Low-frequency ground loops

It is possible that grounding both ends of the overall shield can produce a low frequency ground loop current. If you experience an unacceptable low-frequency noise level, do either of the following:

- ◆ Connect the system (chassis) ground of the external device directly to the digital controller chassis.
  - ◆ Disconnect the overall shield from the metalized back shell at the external device.
- 

## CE compliant cable filtering

To meet CE compliance, additional filtering is required on some of the TestStar chassis rear panel connectors when a cable is connected. Filtering is not required if a cable is not connected or if a jumper plug is installed.

The filter kits (p/n 514744-xx) include a filter, 2 connector screw locks, and instructions for installing the filter. See the following table:

*Continued...*

## CE compliant cable filtering (...continued)

<b>PART NUMBER</b>	<b>CONNECTOR NUMBER</b>	<b>FUNCTION</b>
<b>514744-01</b>	J11	Valve Driver channel 4 (2 stage only)
<b>514744-02</b>	J12	Valve Driver channel 3 (2 stage only)
<b>514744-03</b>	J13	Valve Driver channel 2 (2 stage only)
<b>514744-04</b>	J14	Valve Driver channel 1 (2 stage only)
<b>514744-05</b>	J15	Transducer Monitor 1-7
<b>514744-06</b>	J16	Transducer Monitor 8-14
<b>514744-07</b>	J23A	Hyd Interlock
<b>514744-08</b>	J23B	Hyd Interlock
<b>514744-09</b>	J41A	Readout
<b>514744-10</b>	J41B	Readout (same readouts as J41A)
<b>514744-11</b>	J42	External Data Inputs 1-8
<b>514744-12</b>	J43	Program Interlock
<b>514744-13</b>	J44	Run/Stop
<b>514744-14</b>	J54	Digital Input
<b>514744-15</b>	J55	Digital Output
<b>514744-16</b>	J61	Aux I/O
<b>514744-17</b>	J63	Extended Analog I/O
<b>514744-18</b>	J64	Extended Analog I/O
<b>Filter not needed</b>	J1-J10	Transducer connections
<b>Filter not needed</b>	J11-J14	3 Stage Valve Driver or xdcr connections
<b>Filter not needed</b>	J50	Load Unit Link
<b>Filter not needed</b>	J51	Workstation Link
<b>Filter not needed</b>	J71-J80	I/O BNCs
<b>Filter not needed</b>	J20, 24, 25, 28, 29, 30	Hydraulic control connections
<b>Filter not needed</b>	J111-J114	Auxiliary I/O connections

# Rear Panel Connectors and Cabling

All of the input and output connections that interface the digital controller to other system components are available at the rear panel.

<b>Panel 1</b>	Hydraulic connectors J20, J24, J25, J28, J29, and J30.
<b>Panel 2</b>	Link and readout connectors J41A, J41B, J42, J50, J51, J63, J64, and J71 through J80.
<b>Panel 3</b>	Interlock and digital I/O connectors J23A, J23B, J43, J44, J54, J55, and J61.
<b>Panel 4</b>	Instrumentation connectors J1 through J16.

## Jumper plugs

Connectors J25, 23A, 23B, 29, 30, 43, and 61 maintain the integrity of the interlock system. Connector J50 maintains the integrity of the link communication system. If any of these connectors are not used, a jumper plug must be installed.

The black connectors show the locations that require a cable or jumper plug.

The gray connectors are typically connected.

Each panel is shown in detail on the following pages.

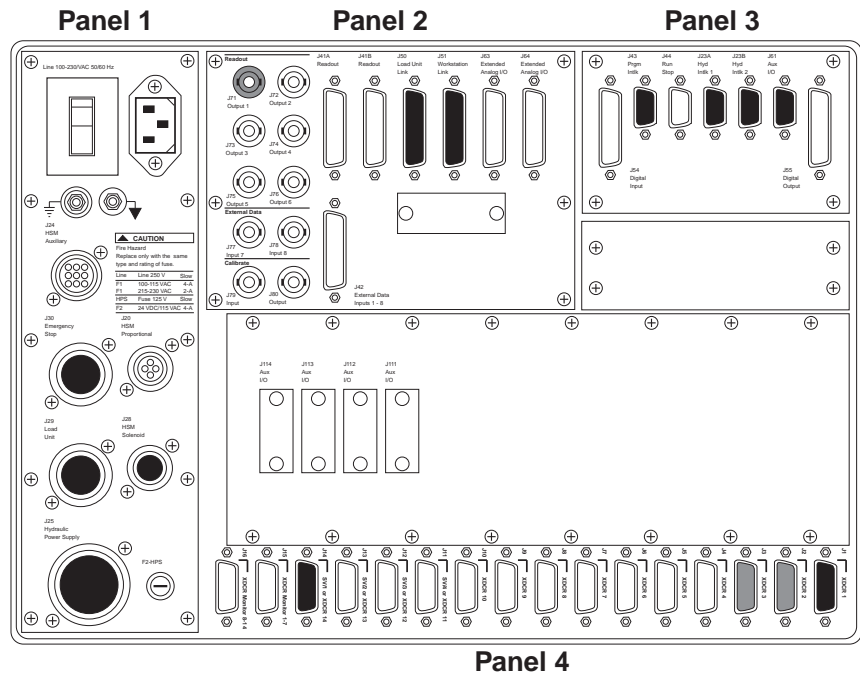

# Panel 1 Connectors

The panel 1 connectors are used primarily for hydraulic connections.

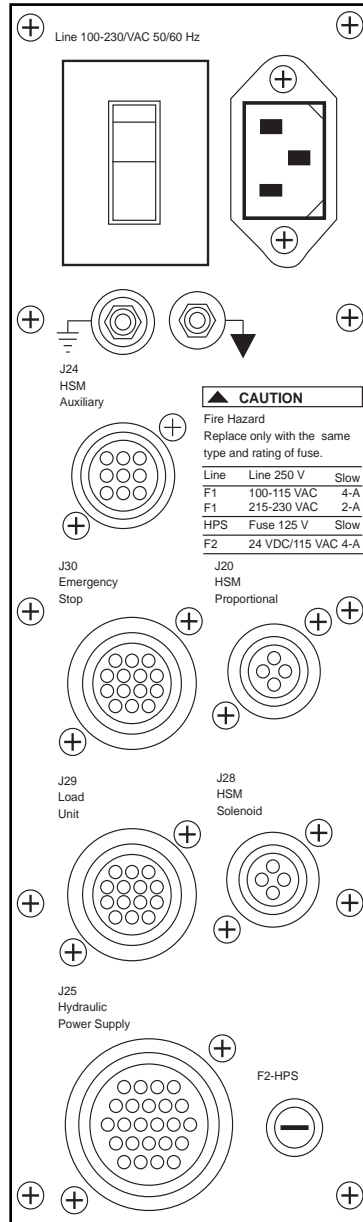



## J20 HSM Proportional

Connector J20 ramps an HSM from low pressure to high pressure at a selectable rate.

- ◆ The output signal can be ramped from 20 mA (minimum) to 800 mA (maximum) which corresponds with 50 psi (0.4 MPa) and 3000 psi (21 MPa).
- ◆ The ramp rate is set when the TestStar software is installed.

The proportional output is configured during the software installation and can be changed using the Reconfigure Hardware mode of the Setup program (see Chapter 4). The following configure the output signal:

- ◆ the ramp rate from off to low pressure
- ◆ the ramp rate from low pressure to high pressure
- ◆ the ramp rate from high pressure to off
- ◆ the low pressure setting

Connector J20 provides a proportional output signal to control a proportional valve (or an electrical pressure reducing valve).

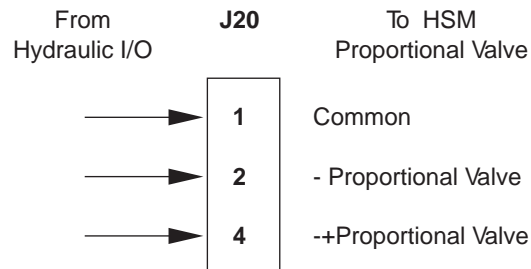

### Cable specification

- ◆ P20 is a 4-contact CPC male connector (AMP Incorporated)
- ◆ Cable – 18 AWG, 2 connector type SJ00W-A
- ◆ Cable assembly number 397026-XX

## J24 HSM Auxiliary

These outputs are reserved for use with additional hydraulic service manifolds.

- ◆ The contacts are rated at 115 Vac at 0.5 A; 30 Vdc at 4A.
- ◆ These contacts are used as required for systems.

Connector J24 provides contacts to control multiple HSMs.

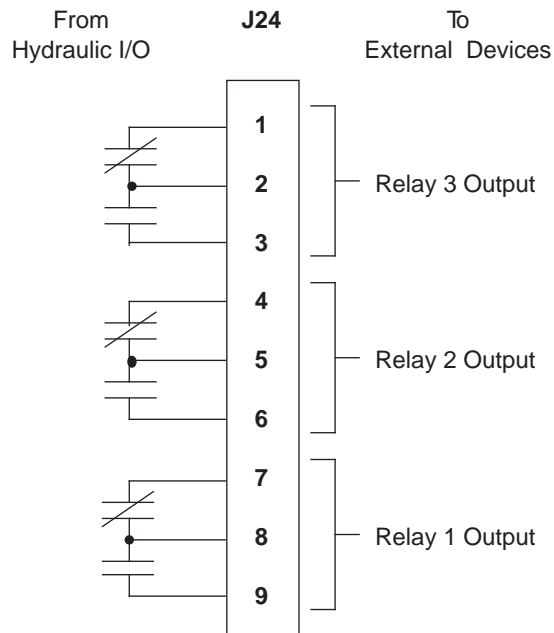

### Cable specification

- ◆ P24 is a 9-contact CPC female connector (AMP Incorporated)
- ◆ Cable – twisted pairs or triples wire size as required (#18 AWG SJO)
- ◆ For 115 Vac requirements use 18 AWG wire

## J25 Hydraulic Power Supply

Connector J25 controls the hydraulic power supply.

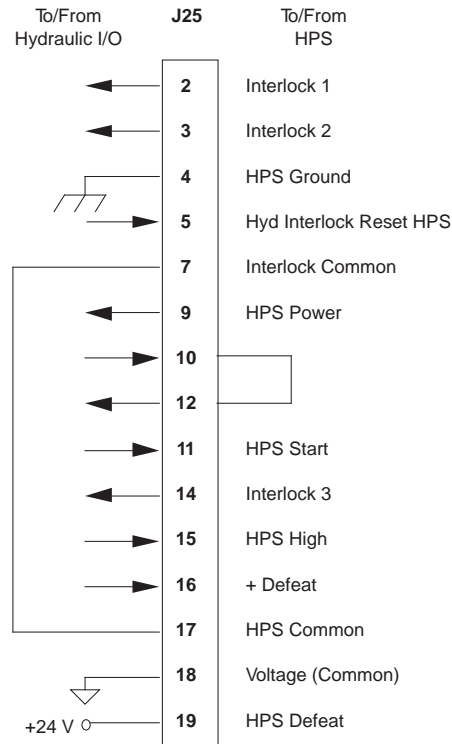

### Cable specification

- ◆ P25 is a 24-contact CPC female connector (AMP Incorporated)
- ◆ Cable – 18 AWG, 14 conductor rated for 300 V
- ◆ Compatible with MTS 24 Vdc or 115 Vac control cables
- ◆ Cable assembly numbers 397087-XX (24 Vdc), 397088-XX (115 Vac)
- ◆ Uses special MTS cable material (442973-01)

### Jumper plug

If an HPS is not connected to the digital controller, a jumper plug is required to maintain the integrity of the interlocks. Use jumper plug 397199-01 or jumper pins: 2 and 3; 3 and 7; 9 and 19; 10 and 12; 11 and 16; 17 and 18.

## J28 HSM Solenoid

The outputs provide 24 Vdc to turn on the HSM solenoids. See Chapter 2 for information about 115 Vac HSM Interface hardware package.

Connector J28 controls the low-pressure and high-pressure solenoids of a hydraulic service manifold.

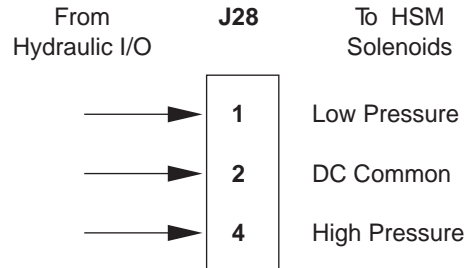

### Cable specification

- ◆ P28 is a 4-contact CPC male connector (AMP Incorporated).
- ◆ Cable – 18 AWG/2 connector type SJO for on/off HSMs  
18 AWG/3 connector type SJO for high/low HSMs
- ◆ Cable assembly numbers:
  - 290.XX HSM, on/off, 24 Vdc, 397053-XX - 18/2 SJO
  - 290.XX/294.XX HSM, high/low, 24 Vdc, 397055-XX - 18/3 SJO
  - 298.11 HSM, on/off, 24 Vdc, 397081-XX 18/2 SJO

## J29 Load Unit

Connector J29 connects to the load unit lift/lock panel.

See Appendix E for cabling information interfacing different types of load units.

See Chapter 2, Section F for information about a Model 380 Load Unit Interface package.

- ◆ Pins 1, 2, 3, and 4 can be configured for contacts or a logic signal.
- ◆ Pins 5, 7, 8, and 13 maintain the continuity of the emergency stop

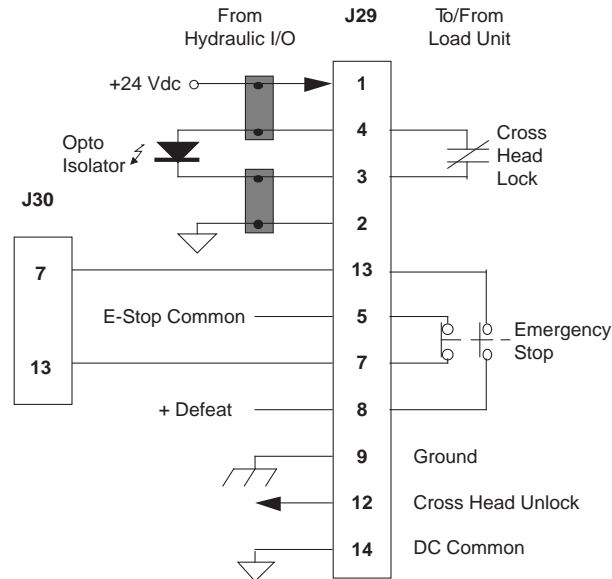

### Cable specification

- ◆ P29 is a 14-contact type CPC male connector (AMP Incorporated)
- ◆ Cable - 18 AWG, 7 conductor w/foil shield (drain to J29-9) and 18 AWG, 5 conductor w/foil shield (drain to J29-9)
- ◆ Cable assembly numbers:
  - 318 Load Unit w/crosshead locks 397185-XX
  - 318 Load Unit wo/crosshead locks 397186-XX
  - 490.05 Load Unit 397187-XX

### Jumper plug

If connector J29 is not used, a jumper plug is required to maintain the integrity of the interlocks. Use jumper plug 397198-01 or jumper pins: 3 and 4; 5 and 7; 8 and 13

## J30 Emergency Stop

Pins 5, 7, 8, and 13 maintain the continuity of the emergency stop interlock.

Connector J30 connects a remote emergency stop switch.

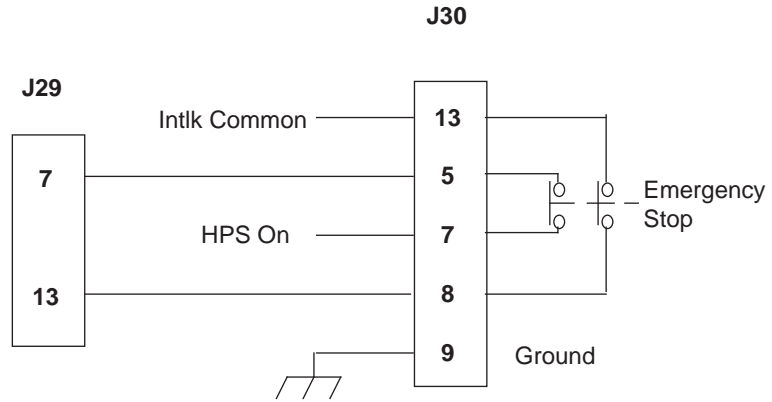

### Cable specification

- ◆ P30 is a 14-contact CPC male connector (AMP Incorporated)
- ◆ Cable - 18 AWG, 5 conductor, w/foil shield (drain to J30-9) and E-Stop box ground
- ◆ Cable assembly number 514734-XX (part of E-Stop station)

### Jumper plug

If connector J30 is not used, a jumper plug is required to maintain the integrity of the interlocks. Use jumper plug 397196-01 or jumper pins: 5 and 7; 8 and 13.

# Panel 2 Connectors

The panel 2 connectors are used primarily to link other TestStar components together and to monitor analog I/O.

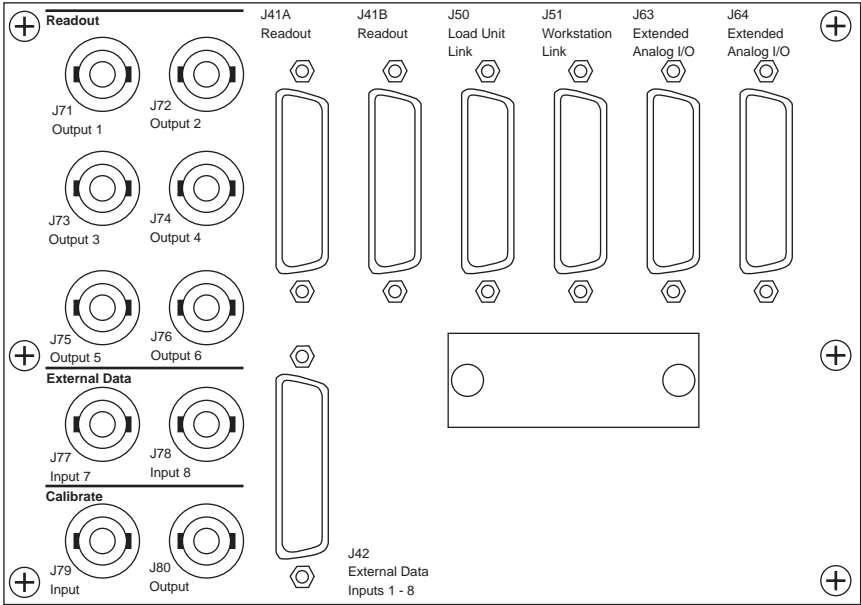

**Note** Connectors J63 and J64 are optional. They are installed when the Extended Analog I/O hardware package is installed (see Section F in Chapter 2 of this manual).

## J41A, J41B Readout

Connectors J41A and J41B provide up to six signals for readout on external devices.

Each readout signal is a differential analog output within  $\pm 10$  V.

The readout signals are also available at J71 - J76.

See Chapter 3 of the Reference manual to define output signals.

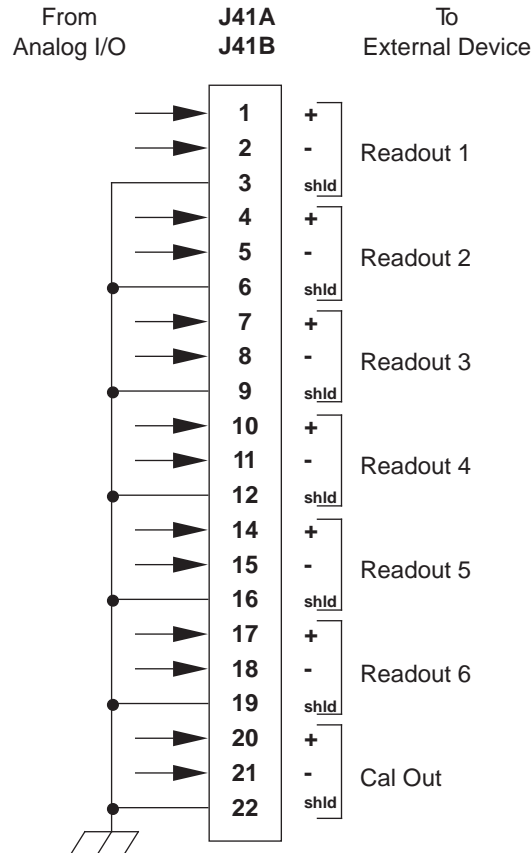

### Cable specification

- ◆ P41 is a 25-contact type D male, tin plated, metal body connector
- ◆ Back shell – EMI metalized plastic
- ◆ Cable – up to 6 twisted, shielded pairs (24 AWG minimum), each with drain wire connected at the P41A/B end only (pins 3, 6, 9, 12, 16, 19, and 22)
- ◆ Each output is shielded



## J42 External Data Inputs 1-8

Connector J42 allow externally conditioned sensor feedback signals or external command signals from another control system to be used by TestStar.

Connector J42 provides connections for up to eight analog input signals.

Each differential analog input must be within  $\pm 10$  V.

BNC connectors J77 and J78 can also be used as the external inputs 7 and 8.

See Chapter 10 for procedures to use external sensors and commands.

Module locations 7 - 14 correspond with external inputs 1 - 7 respectively.

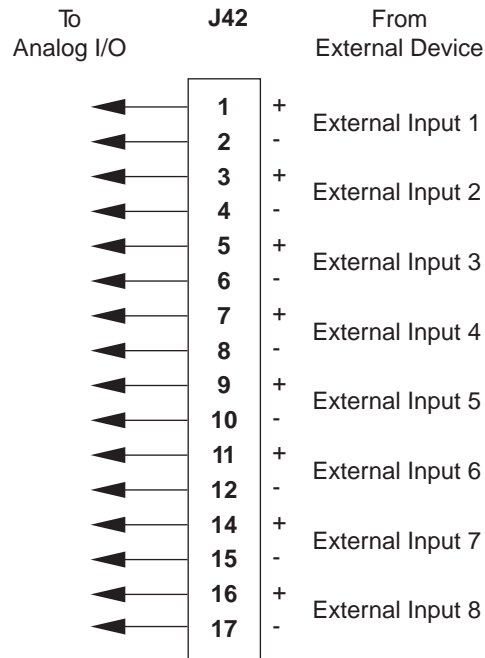

**Note** External inputs 7 and 8 are also available at rear panel connectors J77 and J78 respectively.

### Cable specification

- ◆ P42 is a 25-contact type D male, tin plated, metal body connector
- ◆ Back shell – EMI metalized plastic
- ◆ Cable - European CE compliant
  - up to 8 twisted, shielded pairs, each with drain wire with all pairs enclosed with a common braid shield. All drain wires and braided shield connected to the EMI metalized backshell at the P42 end
- ◆ Cable - not European CE compliant
  - up to 8 twisted, shielded pairs, each with drain wire connected at the signal source end only (not at the P42 end).

## J50 Load Unit Link

Connector J50 provides the required interface between the load unit control panel and the digital controller.

The linkin, linkout, reset, analyze, and error signals are differential signals. A difference of +200 mV results in a "1", a difference of -200 mV results in a "0".

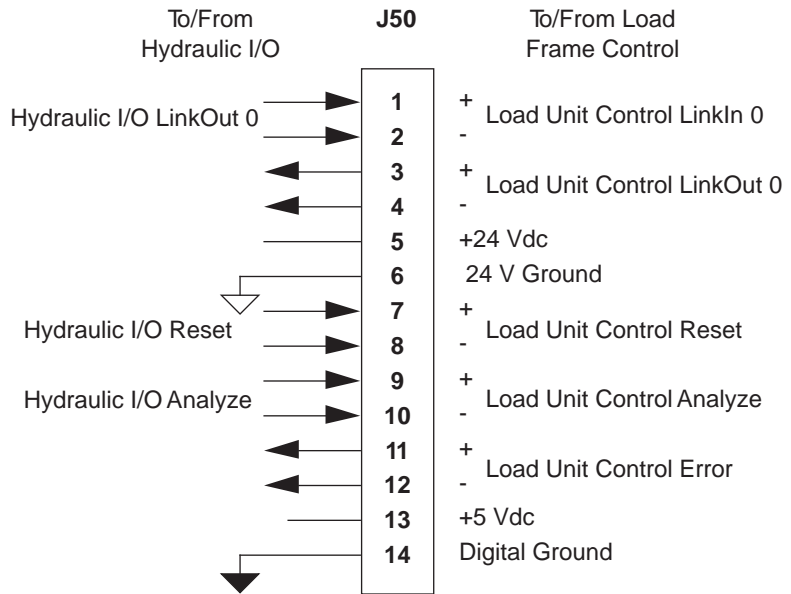

### ⚠ CAUTION

**Do not build this cable in the field. Improper shielding may cause unpredictable operation.**

Proper construction requires special tools and cable material.

### Jumper plug

If this cable is not connected, install the jumper plug P/N 397127-01.

## J51 Workstation Link

Connector J51 provides the required interface between the Workstation and the digital controller.

All of the signals are differential signals. A difference of +200 mV results in a "1", a difference of -200 mV results in a "0".

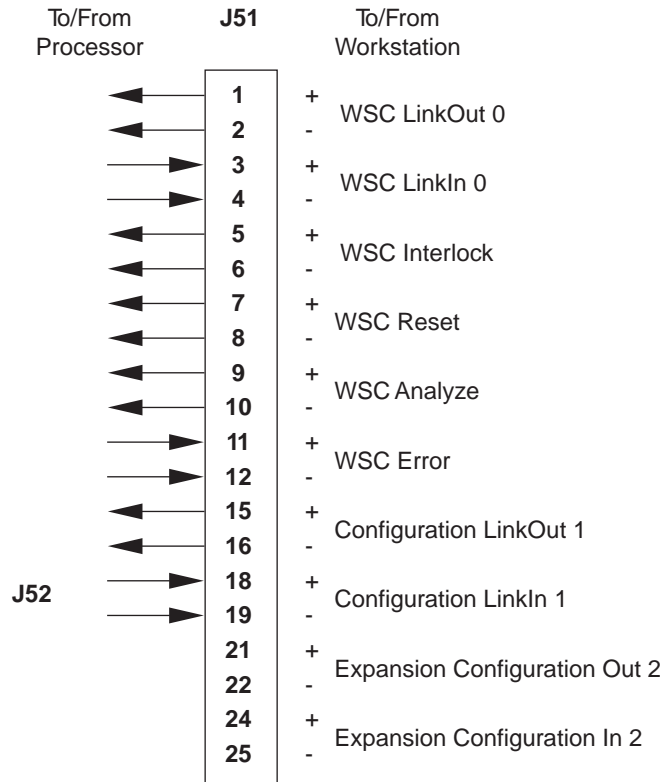

### ⚠ CAUTION

**Do not build this cable in the field. Improper shielding may cause unpredictable operation.**

Proper construction requires special tools and cable material.

## J63/J64 Extended Analog I/O

Connectors J63 and J64 are a part of the optional Extended Analog I/O hardware package. They allow externally conditioned sensor feedback signals or external command signals from another control system to be used by TestStar (just like J42). See Chapter 2 for more information about this package.

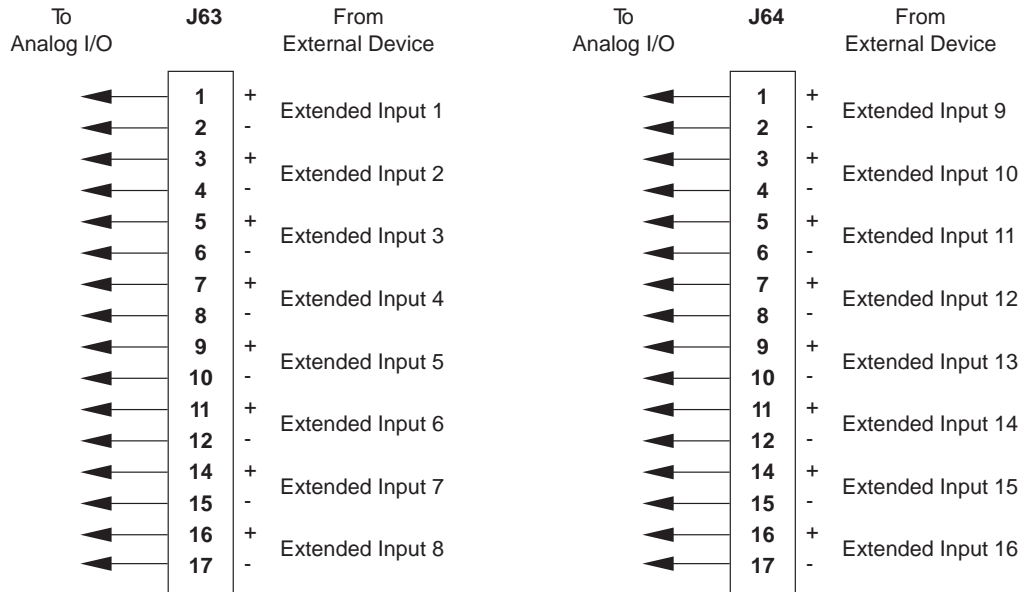

### Cable specification

- ◆ J63 and J64 are 25-contact type D male, tin plated, metal body connectors
- ◆ Back shell – EMI metalized plastic
- ◆ Cable – European CE compliant  
Up to 8 twisted, shielded pairs, each with drain wire with all pairs enclosed with a common braid shield. All drain wires and braided shield connected to the EMI metalized backshell at P63 & P64 end.
- ◆ Cable – not European CE compliant  
Up to 8 twisted, shielded pairs, each with drain wire connected at the source end only (not at P63 & P64 end).

## J71 through J80 BNC Connectors

### Readout

The **Readout** BNC connectors J71 through J76 and **Calibrate Output** connector J80 provide the same signals that are available at connectors J41A and J41B.

Each readout signal is a differential analog output within  $\pm 10$  V.

See Chapter 3 in the Reference manual to define the outputs.

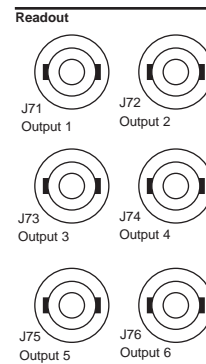

### External Data

The **External Data** BNC connectors J77 and J78 provide the same inputs as connector J42, pins 14 through 17 (input 7 and input 8). When using input 7 or input 8, use only one connector for each channel. Each differential analog input must be within  $\pm 10$  V.

See Chapter 10 to use these connectors.

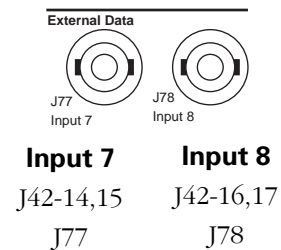

### Calibrate

The **Calibrate** BNC connectors provide an input for an external calibration signal (J79) and an output to monitor the calibration signal (J80). The calibration signals are  $\pm 10$  V.

See Appendix C to use these connections.

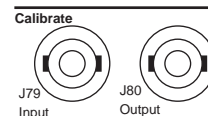

### Cable specification

- ◆ BNC connectors, UG88/U
- ◆ Cable – coaxial RG-58
- ◆ For CE compliance, the outer RG58 cable shield must be connected to ground at the signal source (J77, J78, and J79 inputs only)

# Panel 3 Connectors

---

The panel 3 connectors are primarily used for the interlocks and digital I/O connections.

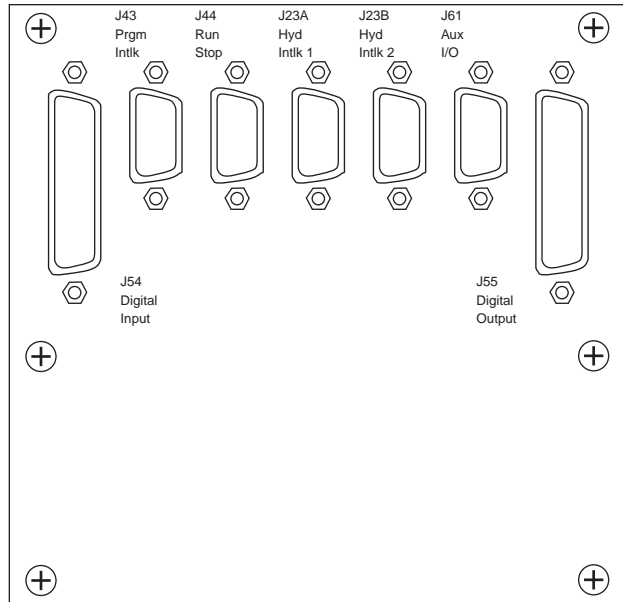

## J23A, J23B Hyd Intlk 1 and 2

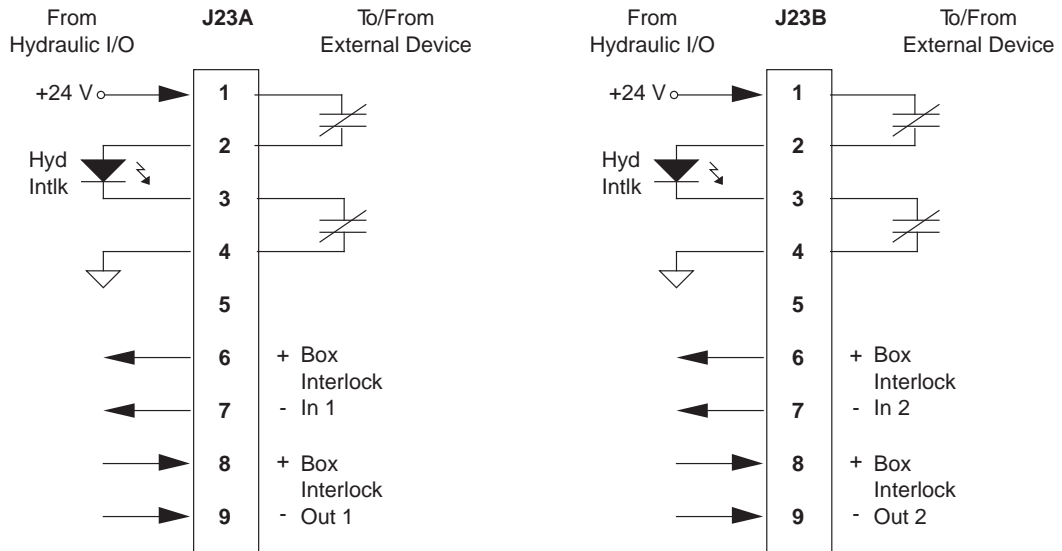

The hydraulic Interlock connections allow external devices to be connected to the hydraulic interlock chain.

Pins 1, 2, 3, and 4 each connector allow two sets of contacts to be installed into the hydraulic chain.

The Box Interlock In and Out signals are differential signals. A difference of +200 mV results in a "1", a difference of -200 mV results in a "0".

### Specifications

- ◆ P23A & B are 9-contact type D male, tin plated, metal body connectors
- ◆ Back shell – EMI metalized plastic
- ◆ Cable – up to four twisted shielded pairs (24 AWG min), all drain wires connected to the EMI metalized plastic back shell at the P23 end.

### Jumper plug

If no external devices are connected to either connector, a jumper plug must be installed. Use jumper plug 397194-01 or jumper pins: 1 and 2; 3 and 4; 6 and 8; 7 and 9 of each connector.

## J43 Prgm Intlk

These connections are reserved for use with application-specific software.

The J43 connector allows up to four external devices to be connected to the program interlock chain.

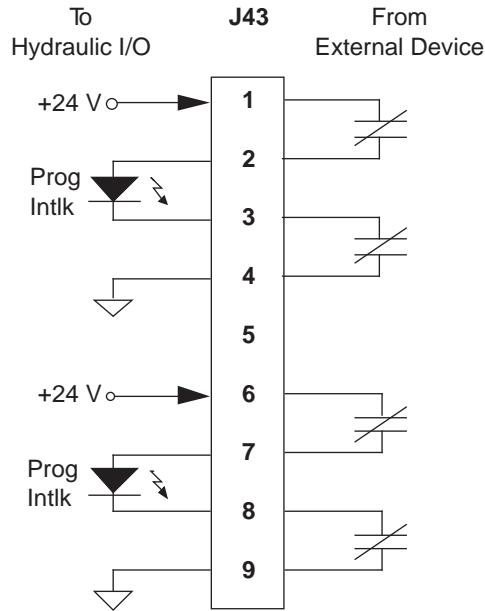

### Cable specification

- ◆ P43 is a 9-contact type D male, tin plated, metal body connector
- ◆ Back shell – EMI metalized plastic
- ◆ Cable – up to four twisted shielded pairs (24 AWG min) all drain wires connected to the EMI metalized plastic back shell at the P43 end.

### Jumper plug

If no external devices are connected to the connector, a jumper plug must be installed. Use jumper plug 397195-01 or jumper pins: 1 and 2; 3 and 4; 6 and 8; 7 and 9 of the connector.



## J44 Run Stop

The J44 connector provides the run/stop status of the digital controller to external devices.

Contact rating is 0.5 A at 30 Vdc.

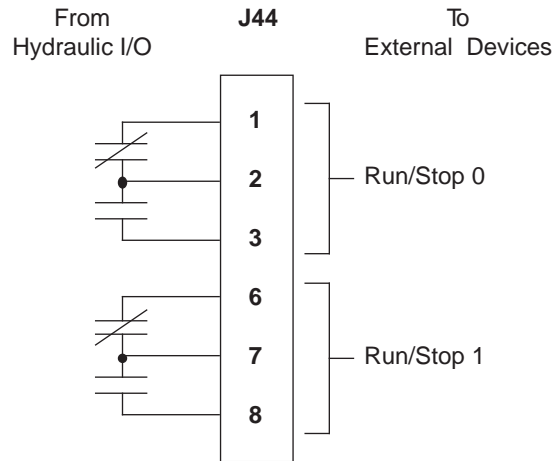

### Cable specification

- ◆ P43 is a 9-contact type D female, tin plated, metal body connector
- ◆ Back shell – EMI metalized plastic
- ◆ Cable – up to 2 shielded twisted pairs or triples (24 AWG minimum), each with a drain wire. All drain wires connected to the EMI backshell at the P44 end

## J54 Digital Input

The J54 connector provides eight general purpose inputs.

The inputs can be configured for relay contacts or logic levels jumpers X1 - X8 on the processor module (see Section B, Chapter 2).

The inputs are used with the Digital Input Detector process in the TestWare-SX application

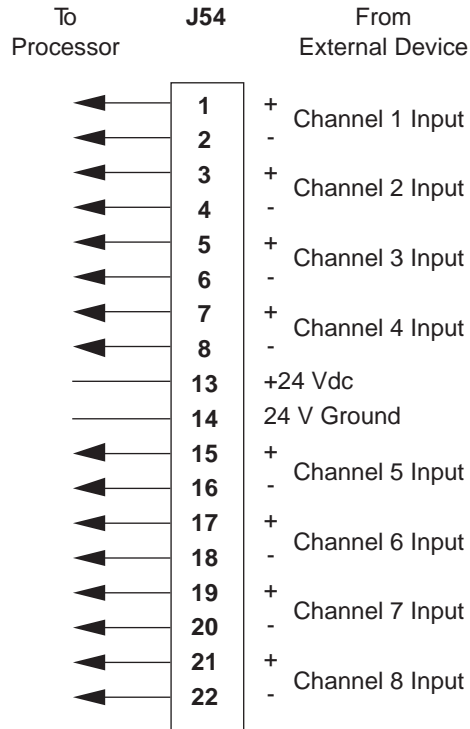

### Cable specification

- ◆ P54 is a 25-contact type D male, tin plated, metal body connector
- ◆ Back shell – EMI metalized plastic
- ◆ Length – 100 feet maximum
- ◆ Cable – twisted pairs as required (24 AWG minimum) with an overall braided shield
- ◆ Fold braided shield under cable clamp of the metalized plastic backshell at the P54 end

## Power characteristics Considerations

Channel inputs can be within 5 volts (minimum) and 24 volts (maximum)

The cabling information shown for Digital In (P54) assumes a single-cable destination (with an overall shield). In other applications, the cable may have more than one destination. For these applications an overall shield is not practical and non-EMI connectors and back shells are permissible.

## Example interfaces

Each of the eight input channel can be configured for a contact or a logic level.

For external switches or relay contacts, only a switched ground is needed.

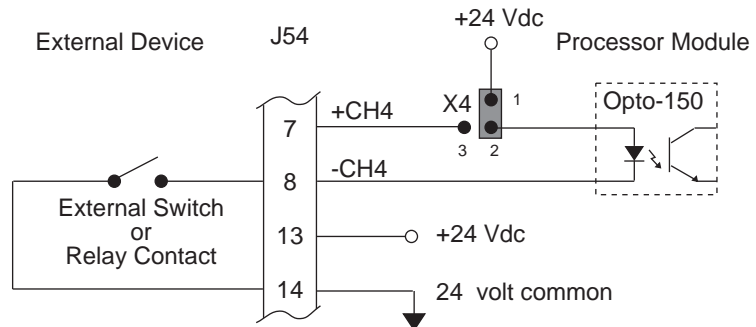

Here, the supplied voltage powers the output of an external optical isolator.

The supplied voltage is unnecessary if the external device can produce a switching signal referenced to a ground (such as a 5 volt logic signal).

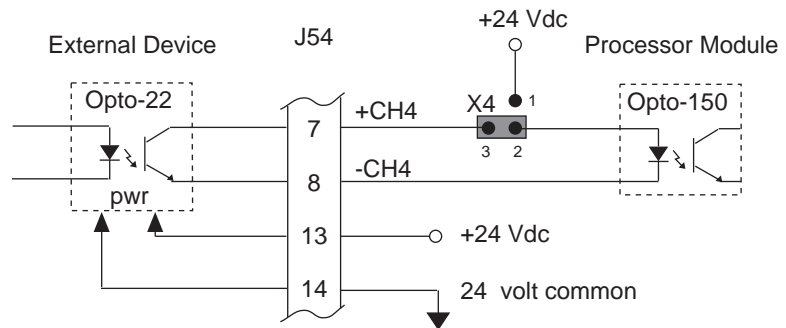

## J55 Digital Output

The digital output is used in conjunction with the Digital Output process in the TestWare-SX application.

The J55 connector provides eight general purpose outputs.

The outputs are optically isolated.

These outputs are used with the Digital Output process in the TestWare-SX application.

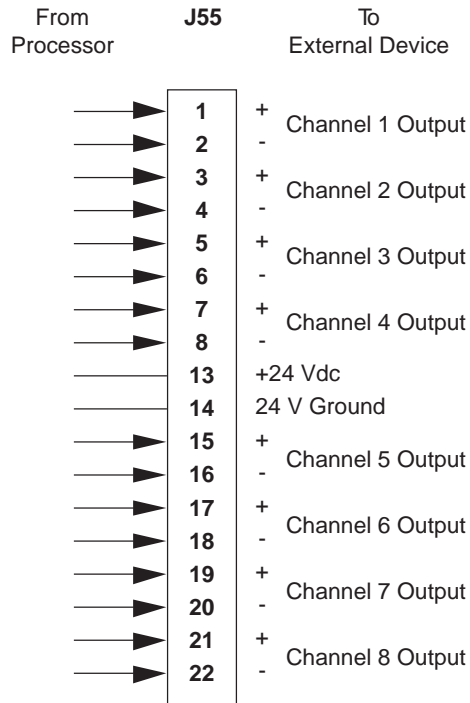

### Cable specification

- ◆ P55 is a 25-contact type D male, tin plated, metal body connector
- ◆ Back shell – EMI metalized plastic
- ◆ Length – 100 feet maximum
- ◆ Cable – twisted pairs as required (24 AWG minimum) with an overall braided shield
- ◆ Fold braided shield under cable clamp of the metalized plastic backshell at the P55 end

## Power characteristics

- ◆ 24 volt output
- ◆ The channel outputs produce a 30 mA sink at a 5 volt drop (max.)

## Considerations

The cabling information shown for Digital Out (P55) assumes a single cable destination (with an overall shield). In other applications, the cable may have more than one destination. For these applications an overall shield is not practical and non-EMI connectors and back shells are permissible.

## Digital Output Process

Use the Digital Output process (TestWare-SX) to signal or trigger Use the Digital Output process (TestWare-SX) to signal or trigger external devices. This process uses connector J55 to signal up to eight outputs.

Each output can be set (+24V), cleared (zero), toggled, or pulsed.

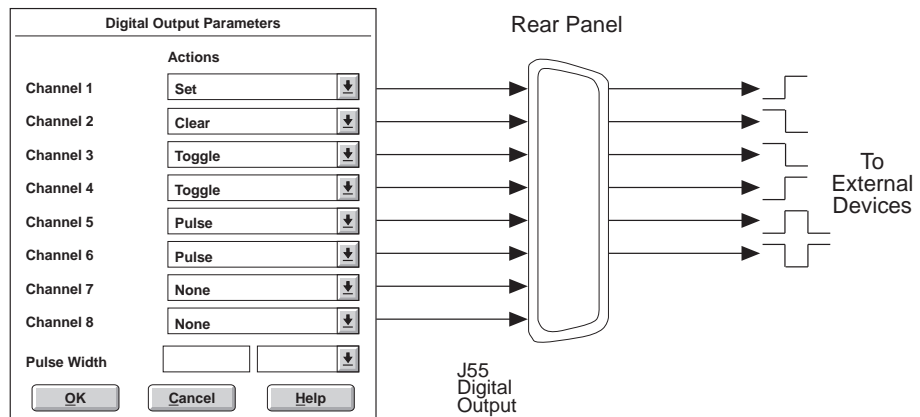

The following define the actions that can be assigned to each output.

<b>ACTION</b>	<b>DEFINITION</b>
<b>None</b>	Disables the channel.
<b>Set</b>	Turns the channel on – a logic high signal (+24 Vdc).
<b>Clear</b>	Turns the channel off – a logic low signal (0 Vdc).
<b>Toggle</b>	Inverts the current state (from high-to-low or low-to-high).
<b>Pulse</b>	Inverts the current state for the duration of the Pulse Width specification.

## J61 Aux I/O

Connector J61 provides an auxiliary set of transputer signals to interface with the digital controller.

The Aux I/O In and Out signals are differential signals. A difference of +200 mV results in a "1", a difference of -200 mV results in a "0".

These connections are reserved for use with application specific software.

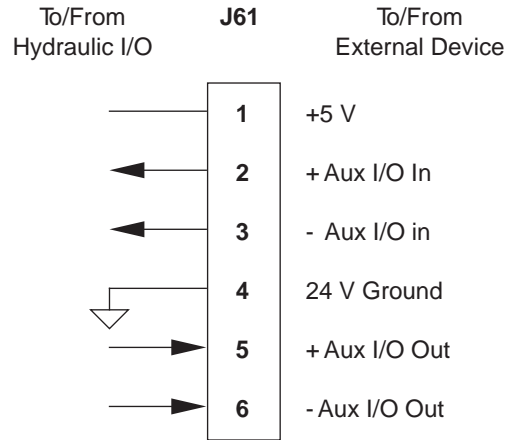

### Cable specification

- ◆ P61 is a 9-contact type D male, tin plated, metal body connector
- ◆ Back shell – EMI metalized plastic
- ◆ Cable – up to 3 twisted shielded pairs (24 AWG minimum) each with a drain wire connected to the EMI metalized plastic backshell at the P61 end.

### Jumper plug

If no external devices are connected to connector J61, a jumper plug must be installed. Use jumper plug 397193-01.

# Panel 4 Connectors

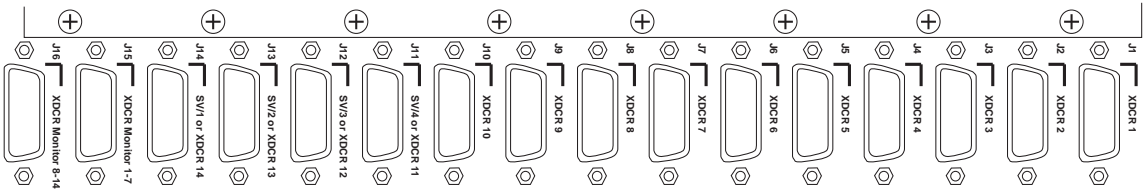

The panel 4 connectors provide connections for sensors, servovalves, and sensor monitors for readout. Each connector location corresponds with a module location on the instrumentation bus.

## Specifications

- ◆ Connectors J1 through J10 are sensor connections.
- ◆ Connectors J11 through J14 can be used for sensor connections or servovalve connections.
- ◆ Connectors J15 and J16 provide readout connections.

EXTERNAL INPUT CHANNELS							
1	2	3	4	5	6	7	8
J42-1,2	J42-3,4	J42-5,6	J42-7,8	J42-9,10	J42-11,12	J42-14,15 J77	J42-16,17 J78

# J1 - J10 Sensor Connections

Connectors J1 through J10 provide sensor connections for the conditioners.

Each sensor connection can define an input signal.

See Chapter 3 in the Reference manuals to define an input signal.

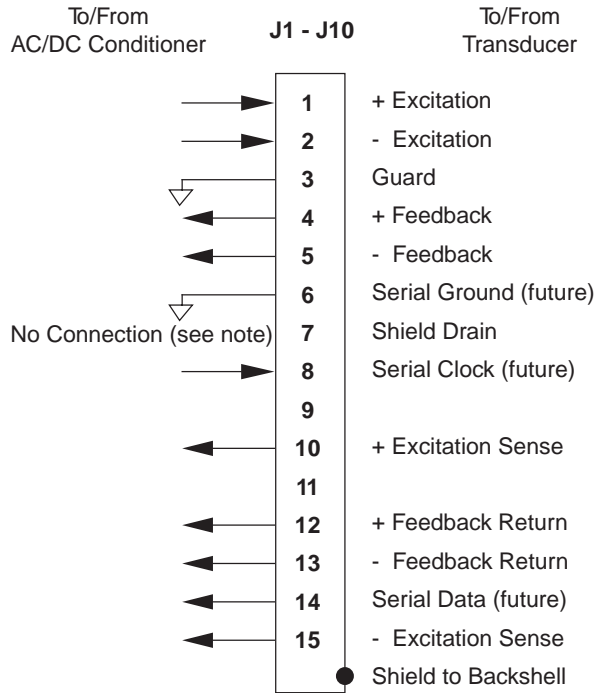

## Cable specification

- ◆ P1 through P10 are 15-contact type D male, tin plated, metal body connectors
- ◆ Back shell – EMI metalized plastic
- ◆ Cable - two twisted shielded pairs with an overall braided shield (MTS material 037244-01). Cable outer shield drain wire to be connected to pin 7 (optional) and cable outer braid folded back under the EMI backshell clamp.

CABLE	ASSEMBLY NUMBERS:
Load cell, 661.XX w/PT connector	397011-XX
Strain	397017-XX
LVDT	397020-XX
ADT	471590-XX



### AC sensor connection

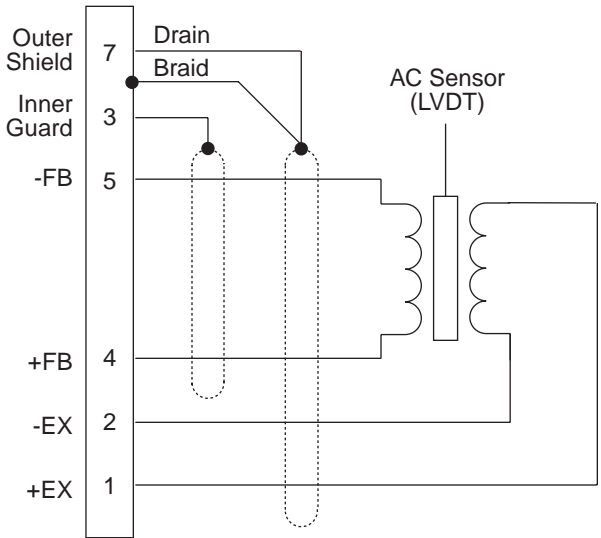

### DC sensor connection

4-wire connections are the most common. An 8-wire connection is typically used for long cables.

The additional wires for an 8-wire connection are shown with dashed lines.

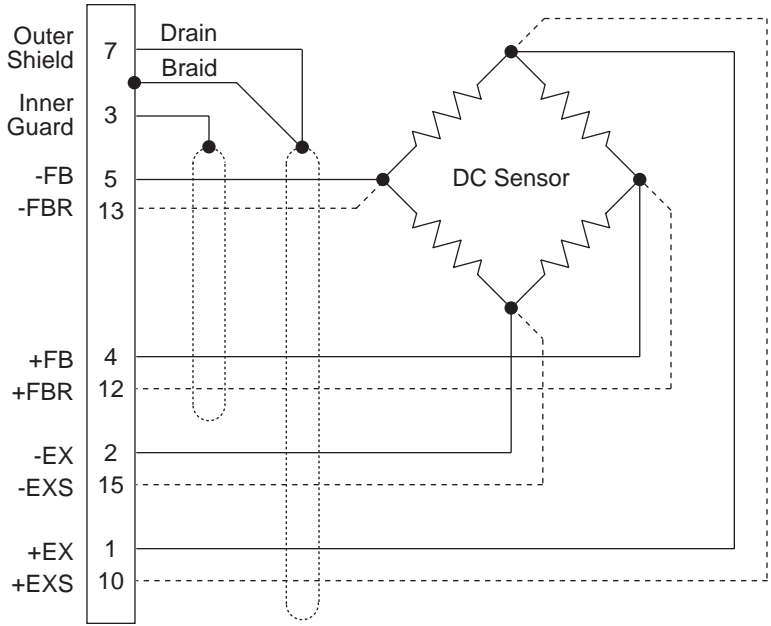

## J11 - J14 Sensor/Servo Valve Connections

Connectors J11 through J14 provide sensor or servovalve connections for the conditioners or valve drivers.

Each servovalve connection can define a control channel.

See Chapter 3 in the Reference manual to define a control channel.

See the previous pages for Sensor connection information.

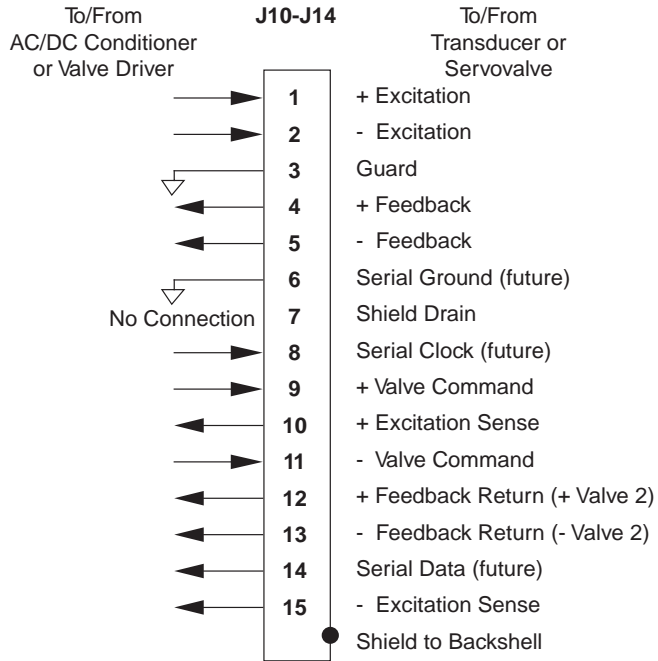

### Cable specification

- ◆ P11 through P14 are 15-contact type D male, tin plated, metal body connector
- ◆ Back shell – EMI metalized plastic
- ◆ Cable – 18 AWG, 4-conductor shielded (Belden 9418 or equivalent)  
Cable outer shield drain wire to be connected to pin 7 (optional) and to the EMI backshell

CABLE	ASSEMBLY NUMBERS:
Transducer	See J1 - J10 assembly numbers
Servovalve, 252/256, single	397006-XX
Servovalve, 252, dual	397007-XX
Servovalve, 256/257 w/valve LVDT	397059-XX
To 448.16C Power Driver (257)	397126-xx

### Single valve connection

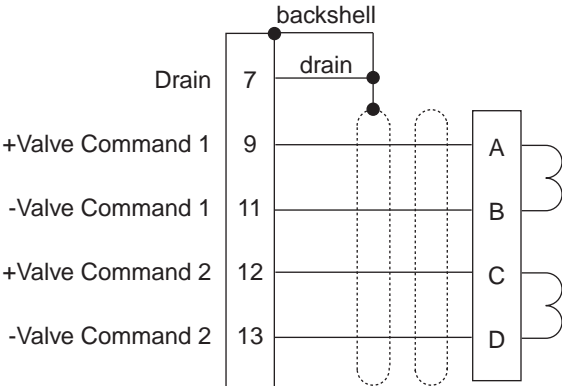

### Dual valve connection

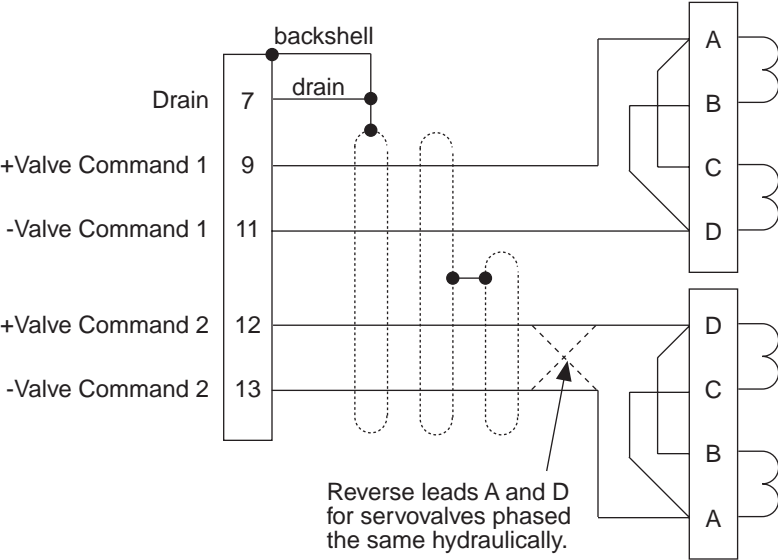

# J15, J16 Sensor Monitor Connections

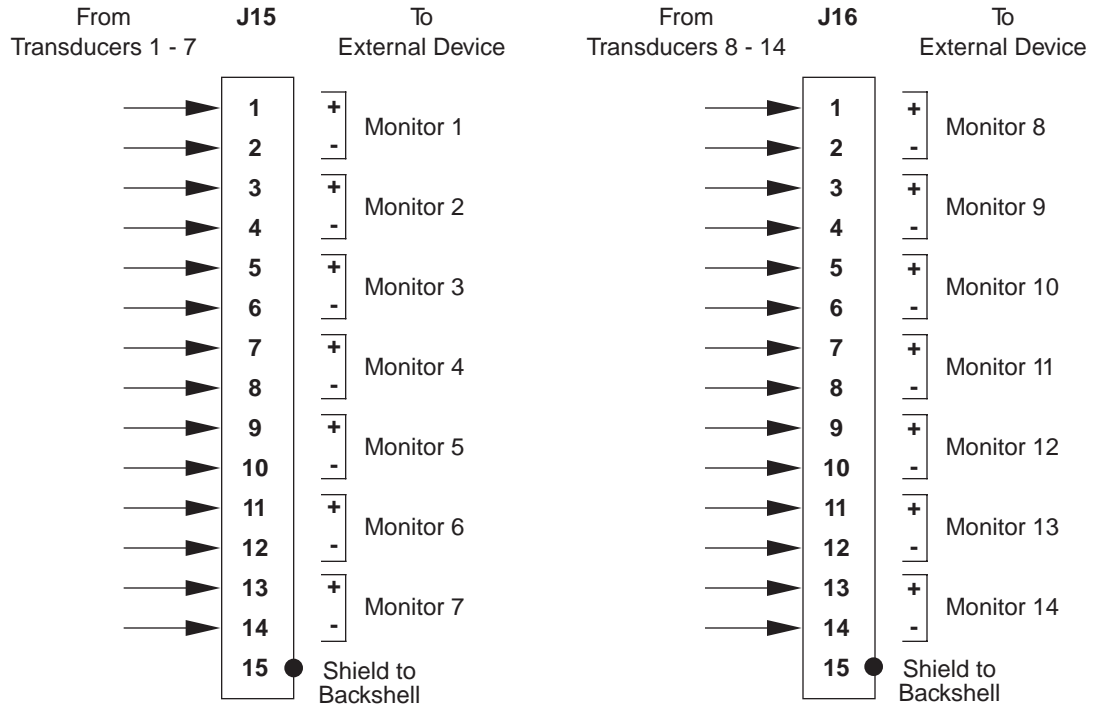

The J15 and J16 connections allow an external device to monitor the transducer signals from module locations 1 through 14.

Each monitor output is within  $\pm 10$  volts.

## Cable specification

- ◆ P15 & P16 are 15-contact type D, tin plated, metal body connectors (see BNC alternative)
  - ◆ Back shell – EMI metalized plastic
  - ◆ Cable - per system requirements, each signal and common should be a twisted, shielded pair (24 AWG min) with drain wire (see below for shield connections).
- 

## Considerations

Because there can be several uses for the monitor signals at P15 and P16 and because individual shield connection points are not available for each signal, the following cabling approaches are permissible.

- ◆ Use twisted shielded pairs and connect all shield drains to the EMI backshell at the P15 and P16 ends (CE compliant).
  - ◆ Use micro coaxial cable (RG-174-U, MTS P/N 118796-05) with BNC connector(s) (MTS 118796-04), cable assembly 460528-01 (not CE compliant).
-

# Auxiliary I/O Panel

These connector locations are used with special hardware packages.

See [Section F: Special Hardware Packages](#) on page 79 for information about optional hardware packages that use this panel.

The Auxiliary I/O panel has locations for additional connectors. These connector locations can provide selected signals for special use.

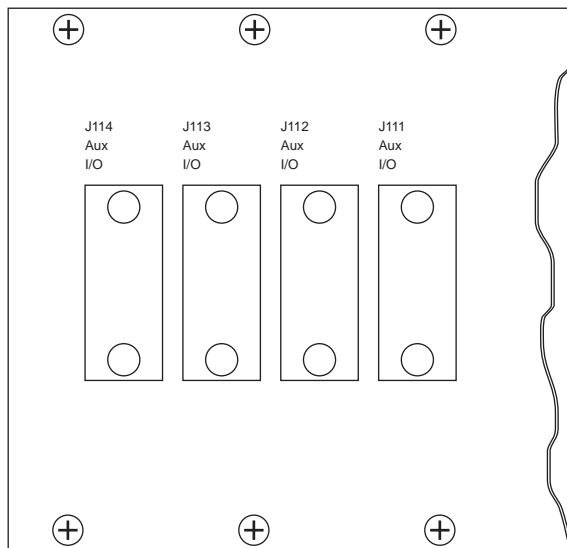

Adding a connector requires the Auxiliary I/O panel to be removed from the rear panel and removing one of the connector blanks. A connector assembly can be attached to the Auxiliary I/O panel and plugged onto the back plane pins of any module connector.

*For example*, an Aux I/O connector is added to accommodate the inner loop LVDT signal of a Series 256 or 257 Servovalve.

## Cable specifications

The following are general requirements for the Auxiliary I/O Panel.

- ◆ P15 & P16 are 15-contact type D, tin plated, metal body connectors (see the BNC alternative on the following page)
  - ◆ Back shell – EMI metalized plastic
  - ◆ Cable – twisted shielded pairs with drain wires, with all drain wires connected to the metalized backshell at the P111 - P114 end
  - ◆ Pinouts – per system requirements
- 

## Alternate BNC cabling:

- ◆ BNC type UG88/U connectors
  - ◆ Cable - coaxial RG-58
  - ◆ For CE compliance the outer RG-58 cable shield must be connected to ground at the signal source end.
-

Auxiliary I/O Panel





# *TestStar™ II*

Control System

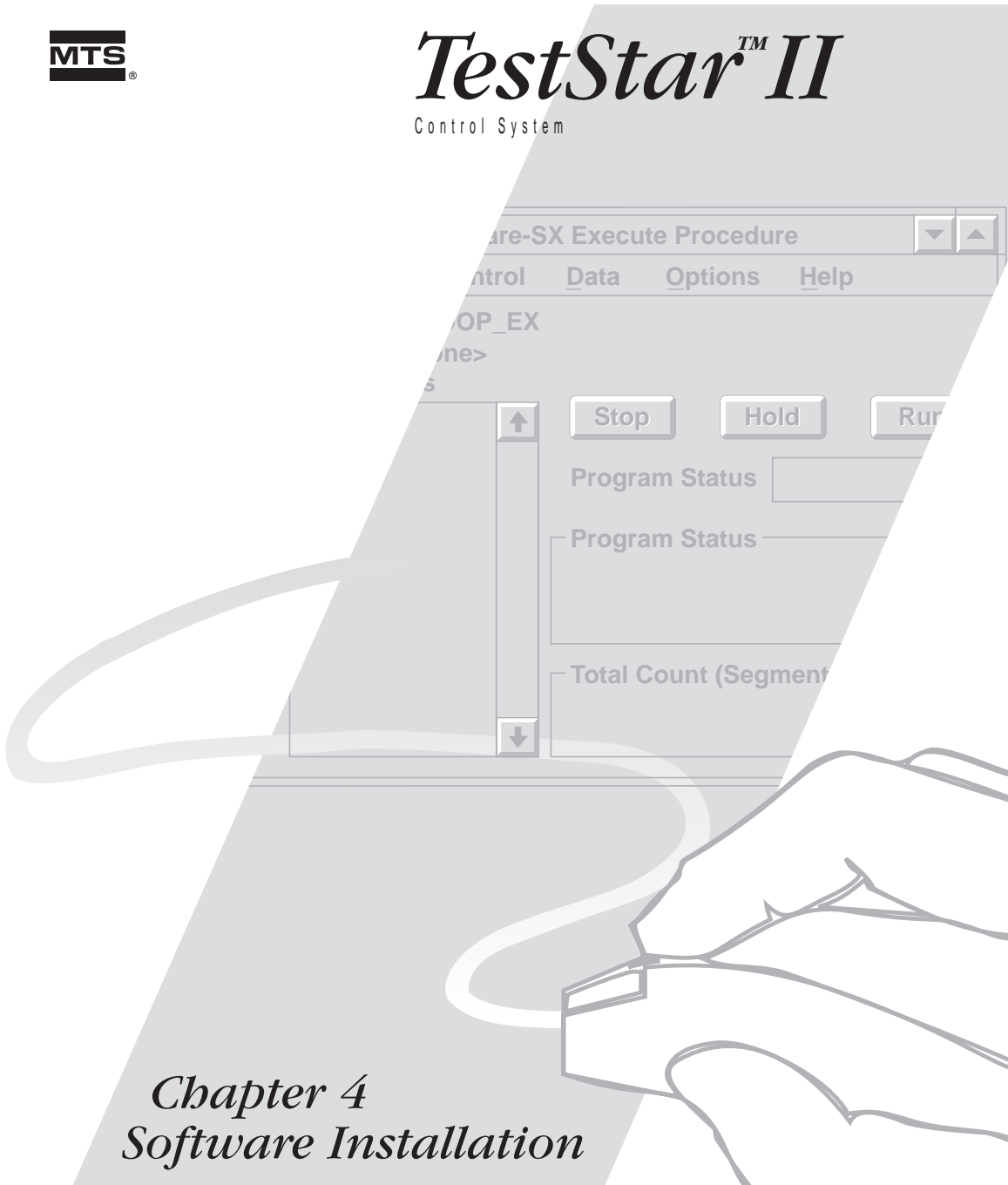

## *Chapter 4 Software Installation*



## Chapter 4

# Software Installation

---

TestStar can be installed on IBM's OS/2 operating system or Microsoft's Windows NT operating system. Each operating system requires a different version of the TestStar Software.

**Note** *The current version of TestStar software is 4.0A. Version 3.1C will continue to be available.*

- ◆ TestStar version 3.1C is for OS/2® Warp®
- ◆ TestStar version 4.0A is for Microsoft® Windows NT®

---

### Contents

Installing TestStar V3.1C 156

Moving TestStar V3.1 Files to TestStar V 4.0 180

Installing TestStar V4.0 182

---

# Installing TestStar V3.1C

---

The following procedure describes how to install TestWare version 3.1C. This version of TestStar is for OS/2 version 3.0 Warp.

Use the TestStar setup program to:

- ◆ Install the TestStar software for the first time
  - ◆ Install TestStar software updates
  - ◆ Redefine the TestStar hardware configuration
  - ◆ Install any optional applications
- 

## Prerequisites

We assume that the OS/2 version 3.0 Warp operating system is properly installed in your computer. We also assume you have turned your computer on and have OS/2 running.

- ◆ You must install software updates in the order of release. For example, from version 1.4 to version 2.0x and from version 2.0x to version 3.0x.
- 

## Backup the software

Make a copy of the Test Star system software. Use the copies to install the TestStar software onto the hard disk. Keep the original TestStar software in a safe, cool, dry place.

---

## Read the readme file

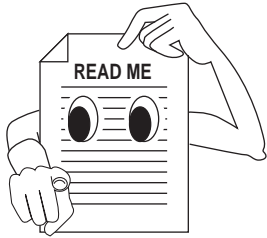

### Before you begin

TestStar system software generally includes a README.TXT file that contains late-breaking information not included in TestStar manuals. If the file is included, it should be opened and the information reviewed before installing the system software. The file is typically located on disk 1.

To read the file, double-click the README.TXT file in drive A or open an OS/2 window and enter the following command:

#### **TYPE A:README.TXT | MORE**

Press any key to display the next page of the file. Press ^C (cntl + C) to exit the file.

---

Locate the following floppy disks:

- ◆ The TestStar System Software disks.
- ◆ The System Calibration disk includes the calibration data for the Analog I/O module. This disk may include sensor calibration data for sensors calibrated at MTS Systems Corp. This disk is only needed for the initial installation.
- ◆ Any additional application disks such as TestWare-SX.
- ◆ Read the README.TXT file (typically on disk 1) for late-breaking information that may not be included the manuals.

## Know your system

You need to know the following information to complete the initial installation:

- ◆ Hydraulic pump configuration (none, on/off, or off/low/high)
- ◆ Hydraulic service manifold configuration (none, on/off, off/low/high, or proportional)

## Setup program

The setup program can be run from disk 1 of the TestStar software (as described in Task 1). After the software installation it can be run from the hard disk (C:\TS2\SETUP) to change hardware or software parameters.

## Operational modes

The TestStar setup program has 5 modes of operation.

MODE	FUNCTION
Initial Software Installation	Installs the TestStar software for the first time.
Update Software Installation	Installs new versions of the TestStar software. Use this selection to install TestStar v3.0 on a system that has v2.0 currently installed.
Reconfigure Software	Selects the software parameters such as the language used for the windows and menus.
Reconfigure Hardware	Identifies certain devices connected to the digital controller such as the number of control channels, the type of HSM, or the type of HPS.
Additional Application Installation	Installs optional TestStar applications or application software upgrades.

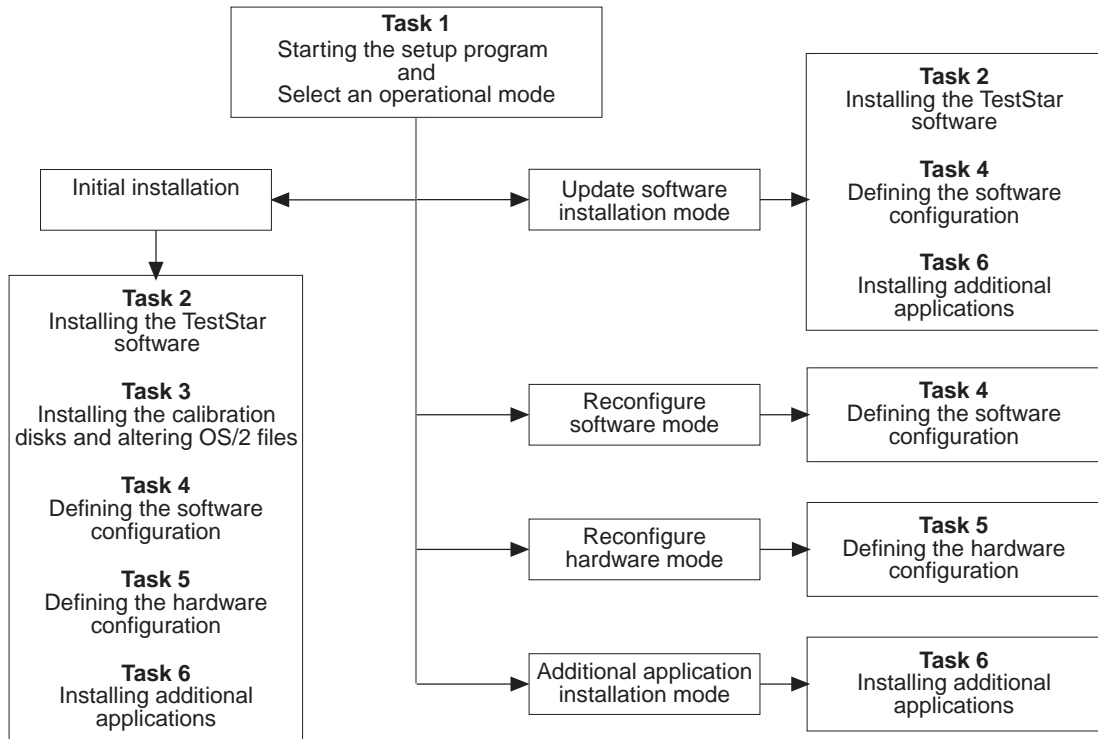

## Abbreviated Procedure

---

- Task 1 Starting the Software Installation Program 161
1. Start the software installation program 161
  2. Select the Setup Program's Operational Mode 161
- Task 2 Installing the TestStar Software 162
1. Enter the TestStar directory path 162
  2. Note about the readme file 162
  3. Insert TestStar Disk 2 into the floppy drive 163
  4. Insert TestStar Disk 3 into the floppy drive 163
  5. Insert the example programs 163
  6. Insert TestStar Disk 4 into the floppy drive 164
- Task 3 Installing the Calibration Disks and Altering OS/2 Files 165
1. Install the System Calibration data 166
  2. Install the Sensor Calibration data 166
  3. Install the External Sensor Calibration data 167
  4. Alter the Startup.cmd file 167
  5. Alter the Config.sys file 167
- Task 4 Defining the Software Parameters 168
1. Define the TestStar directory for configuration files 168
  2. Select the default engineering units 168
  3. Select the TestStar language 169

*Continued...*

Task 5 Defining the Hardware Configuration 170

1. Do you have extended AIO 170
2. Do you have high speed data acquisition 171
3. Select the system configuration 171
4. Identify the pump configuration 172
5. Enter the number of control channels 172
6. Enter the module location of the Valve Driver 173
7. If necessary, enable the CE compliant feature 173
8. Identify the manifold configuration 174
9. Select a comm port for a temperature controller 175
10. If necessary, set up the acceleration compensation option  
177

Task 6 Installing Additional Applications 178

Task 7 Completing the Software Installation 179



## Task 1 Starting the Software Installation Program

---

### Step 1 Start the software installation program

The software installation program is called setup.exe. Perform the following:

- A Insert TestStar Disk 1 in a floppy drive.
- B Double-click the Drive A icon.
- C Double-click the SETUP.EXE icon. This starts the software installation program.

**Note** *If you intend to use the operational modes to modify existing software parameters, hardware configuration, or adding applications, you can find the setup program at this location C:\TS2\SETUP after you install the TestStar software.*

---

### Step 2 Select the Setup Program's Operational Mode

- ◆ Select **Initial Software Installation** if you are installing the TestStar software for the first time (this is used only once).
  - ◆ Select **Update Software Installation** if you are installing a newer version of the TestStar software or reloading the software after the initial installation. Software updates must be installed in the order of their release.
  - ◆ Select **Reconfigure Software Parameters** if you want to change the language used in the TestStar windows and menus (English, French, German). This selection only uses task 4.
  - ◆ Select **Reconfigure Hardware** if you changed a hydraulic component, the number of control channels, or added a temperature controller. This selection only uses Task 5.
  - ◆ Select **Additional Application Installation** if you are installing an optional MTS application program. This selection only uses Task 6.
-

## Task 2 Installing the TestStar Software

---

- Task2 Procedure**
1. Enter the TestStar directory path 162
  2. Note about the readme file 162
  3. Insert TestStar Disk 2 into the floppy drive 163
  4. Insert TestStar Disk 3 into the floppy drive 163
  5. Insert the example programs 163
  6. Insert TestStar Disk 4 into the floppy drive 164
- 

### Step 1 Enter the TestStar directory path

This step is only necessary if you are installing the TestStar software for the first time, or you installed your software in a directory other than C:\TS2. Be sure the drive is formatted for OS/2. The setup program displays the following prompt:

**Please enter the desired location for the TestStar executable files.**

The default location— C:\TS2 is shown in the entry field. If you choose a different location, edit the entry field to show your desired location.

Press the **OK** pushbutton.

---

### Step 2 Note about the readme file

The installation program asks if you have read the readme file.

- ◆ Select **Yes** to continue the installation procedure.
- ◆ If you select **No**, a message is displayed that tells you that the readme file will be displayed. When you have finished reading the file, close the window to continue the setup program.

The first page of this chapter has more information about the readme file. At this point the setup program begins to copy the contents of disk 1 to the hard disk.

---

### Step 3 Insert TestStar Disk 2 into the floppy drive

When the files of Disk 1 are copied, the setup program displays the prompt

**Please Enter TestStar Installation Disk 2.**

Remove Disk 1 from the drive and install Disk 2. Press the OK pushbutton and the setup program begins copying the Disk 2 files.

---

### Step 4 Insert TestStar Disk 3 into the floppy drive

When the files of Disk 2 are copied, the setup program displays the prompt

**Please Enter TestStar Installation Disk 3.**

Remove Disk 2 from the drive and install Disk 3. Press the OK pushbutton and the setup program begins copying the Disk 3 files.

---

### Step 5 Insert the example programs

When the files of Disk 3 are copied, the setup program displays the prompt

**Do you want to install the programming environment plus example programs?**

Four sets of example programs are included: BASIC examples and C language examples. These text files can be compiled with the appropriate compiler. These files are installed in following locations:

- ◆ Microsoft C6.0 examples are installed at C:\TS2\examples\msc
- ◆ Borland C++ examples are installed at C:\TS2\examples\borc
- ◆ Microsoft 7.0 BASIC examples are installed at C:\TS2\examples\msbasic
- ◆ IBM Set++ examples are installed at C:\TS2\examples\ibmc

A ReadMe.ex file located in the examples directory explains the examples. An optional Programming Reference manual is available.

- ◆ Select **Yes** if you plan to use the TestStar programming calls.
  - ◆ Select **No** if you do not plan to use the programming calls.
-

## Step 6 Insert TestStar Disk 4 into the floppy drive

When the files of Disk 3 are copied, the setup program *may* display the prompt

### **Please Enter TestStar Installation Disk 4.**

Remove Disk 3 from the drive and install Disk 4. Press the **OK** pushbutton and the setup program begins copying the Disk 4 files.

---

## Task 3 Installing the Calibration Disks and Altering OS/2 Files

---

Every TestStar digital controller includes a System Calibration disk with calibration data for the Analog I/O module.

In order to run TestStar, the Startup.cmd and Config.sys files must be altered by the installation program. These files Startup.MTS and Config.MTS list the changes made to the system files. This needs to be done once only, when the TestStar system software is installed for the first time.

### Task 3 procedure

1. Install the System Calibration data 166
2. Install the Sensor Calibration data 166
3. Install the External Sensor Calibration data 167
4. Alter the Startup.cmd file 167
5. Alter the Config.sys file 167

#### CAUTION

---

**During the initial software installation, the Startup.cmd and Config.sys files must be altered.**

**Do not** alter these files when installing a software update (or reinstalling the TestStar software). If they are altered a second time, you will encounter problems with your computer when you reboot at the end of this procedure. You will need to contact MTS Systems Corporation to correct this problem.

---

## Step 1 Install the System Calibration data

The setup program displays the prompt:

### Do you wish to install the System Calibration (Analog I/O) file?

- ◆ If you are installing the software for the first time, insert the System Calibration disk in drive A and press the **Yes** pushbutton.
- ◆ If you are installing a software update, press the **No** pushbutton.

---

**Note** Steps 2 and 3 are looking for a sensor database—NOT individual sensor files. A sensor database is a file that contains the calibration information for all your sensors. This file is created using the Sensor Calibration program.

*If you have a disk that contains the file SENS\_DB.DB, use it for step 2.*

*If you have a disk that contains the file EXT\_DB.DB, use it for step 3.*

*If you only have individual calibration disks for each sensor you must use the Sensor Calibration program to import your sensor calibration files to create a database. See Chapter 9 (Calibration Data) in this manual. Also, once the sensor database is created, export the file for backup.*

---

## Step 2 Install the Sensor Calibration data

The setup program displays the prompt:

### Do you wish to install the system Sensor Calibration data base (SENS\_DB.DB)?

- ◆ If you have sensors calibrated at MTS that are included with a new system, the sensor calibration data base is recorded on the System Calibration disk. Press the **Yes** pushbutton.
  - ◆ If you have sensors calibrated at MTS that are not included with a new system, the sensor calibration data is recorded on a disk. The calibration data should be imported to an installed data base with the Sensor Calibration program.
  - ◆ If you do not have calibrated sensors, press the **No** pushbutton. You can create the sensor calibration data base with the Sensor Calibration program.
  - ◆ If you are installing a software update, press the **No** pushbutton. Your data is already installed.
-

### Step 3 Install the External Sensor Calibration data

The setup program displays the prompt:

**Do you wish to install the system External Sensor Calibration data base (EXT\_DB.DB)?**

- ◆ If you have external sensors calibrated at MTS that are included with a new system, the sensor calibration data base is recorded on the System Calibration disk. Press the **Yes** pushbutton.
  - ◆ If you have external sensors calibrated at MTS that are not included with a new system, the sensor calibration data is recorded on a disk. The calibration data should be imported to an installed data base with the Sensor Calibration program.
  - ◆ If you do not have calibrated sensors, press the **No** pushbutton. You can create the sensor calibration data base with the Sensor Calibration program.
  - ◆ If you are installing a software update, press the **No** pushbutton. Your data is already installed.
- 

### Step 4 Alter the Startup.cmd file

The setup program displays the prompt:

**Do you want your STARTUP.CMD file altered for running TestStar?**

- ◆ If you are installing the software for the first time, press the **Yes** pushbutton.
  - ◆ If you are installing a software update or re-installing the software, press the **No** pushbutton.
- 

### Step 5 Alter the Config.sys file

The setup program displays the prompt:

**Do you want your CONFIG.SYS file altered for running TestStar?**

- ◆ If you are installing the software for the first time, press the **Yes** pushbutton. Altering the Config.sys file takes a few minutes.
  - ◆ If you are installing a software update or re-installing the software, press the **No** pushbutton.
- 

If you change a jumper setting on the WSCI board, you will need to edit the config.sys file. See page 70.

## Task 4 Defining the Software Parameters

---

The software parameters establish a default set of units and the language for the TestStar windows and menus.

- Procedure**
1. Define the TestStar directory for configuration files 168
  2. Select the default engineering units 168
  3. Select the TestStar language 169
- 

### Step 1 Define the TestStar directory for configuration files

The setup program displays the prompt:

**Please enter the default Subdirectory location for the TestStar configurations.**

When you save TestStar configuration files the Save window uses this directory path as its default location. The default location is shown.

---

### Step 2 Select the default engineering units

The setup program displays the prompt

**Select the default Unit Assignment Set you wish to use.**

Default engineering units are initially assigned to each TestStar parameter. You can then change the units for any individual parameter or create an entire set of new default units.

♦ Select **SI Units** (metric) or **U.S. customary**.

**Note** *The default engineering units can be changed using the Unit Assignment Set Editor located in the Utilities folder.*

---



### Step 3 Select the TestStar language

The setup program displays the prompt

**Select the language for TestStar and its applications.**

- ◆ English
- ◆ German
- ◆ French
- ◆ Kanji (Japanese)

If you select German, French, or Japanese, you are prompted to install the language disk.

---

## Task 5 Defining the Hardware Configuration

---

The TestStar system software needs to know the capabilities of the hardware components of your system.

### Procedure

1. Do you have extended AIO 170
  2. Do you have high speed data acquisition 171
  3. Select the system configuration 171
  4. Identify the pump configuration 172
  5. Enter the number of control channels 172
  6. Enter the module location of the Valve Driver 173
  7. If necessary, enable the CE compliant feature 173
  8. Identify the manifold configuration 174
  9. Select a comm port for a temperature controller 175
  10. If necessary, set up the acceleration compensation option 177
- 

### Step 1 Do you have extended AIO

Extended AIO (analog input/output) adds 16 additional external inputs to the system. The setup program displays the prompt:

#### Does the TestStar system have an extended AIO card?

**Note** Compare the following with the selections of the next question.

- ♦ Select **Yes** if rear panel connectors J63 and J64 are installed and two Model 490.40 Analog I/O boards are installed. If you select **Yes**, the program asks for the extended Analog I/O calibration data file.
  - ♦ Select **No** if rear panel connectors J63 and J64 are NOT installed or one Model 490.40 Analog I/O board is installed.
-

## Step 2 Do you have high speed data acquisition

High Speed Data Acquisition allows data collection at a rate of 70 kHz using the optional 790.16 High Speed Data Acquisition process.

### Does your system have a High Speed Data Acquisition board?

- ◆ Select **Yes** if two Model 490.40 Analog I/O boards and rear panel connectors J63 and J64 are NOT installed. Also, the Model 790.16 High Speed Data Acquisition software is at hand.

**Note** *If you do have the High Speed Data Acquisition board, you will also be asked about static cross coupling. The static cross coupling feature is set up by MTS service technicians.*

- ◆ Select **No** if rear panel connectors J63 and J64 are NOT installed and one Model 490.40 Analog I/O board is installed.
- 

## Step 3 Select the system configuration

The setup program displays the prompt:

### Select the system configuration.

**Hydraulic**  
**Electro-mechanical**

The selections represent the type of equipment you are configuring.

- ◆ Select Hydraulic if your system uses hydraulic test equipment.
- ◆ Select Electro-mechanical if your system uses servo motor equipment.

**Note** *If Electro-mechanical is selected, all TestStar windows using the word "Hydraulic" will be changed to "Servo motor."*

---

## Step 4 Identify the pump configuration

The setup program displays the prompt:

### Select the hydraulic power supply [HPS] configuration.

The configuration selections represent the control capabilities of the hydraulic power supply (HPS or hydraulic pump).

- ◆ If you do not want the TestStar system to control your pump, select **none** (a jumper plug is required, refer to chapter 3).

**Note** We recommend you use the Error Detector with this configuration.

- ◆ If your pump can be turned on and off only, select **2-state**.
- ◆ If your pump can apply low hydraulic pressure, high hydraulic pressure, and be turned off, select **3-state**.

## Step 5 Enter the number of control channels

The setup program displays the prompt:

### Select the maximum number of control channel(s) your system hardware supports.

The number of control channels represents the number of actuators or Valve Driver modules in your system. The load unit control panel has an Actuator Positioning Control for each control channel.

This diagram shows the control channel locations on the load unit control panel for multiple channel systems.

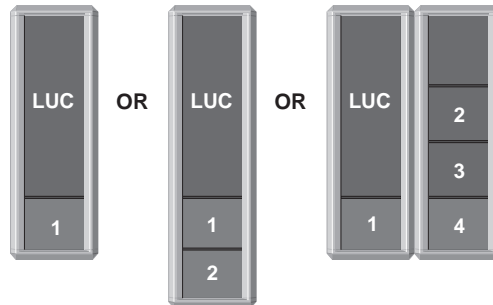

Enter the number of control channels on your system (1 - 4).

**Note** If more than one channel is selected, steps 4 through 6 are repeated for each channel. You will be asked to define an HSM for each channel.

**Step 6 Enter the module location of the Valve Driver**

The setup program displays the prompt:

**Please enter the slot number of the valve driver (11-14) for channel x.**

Each control channel requires a Model 490.14 or 490.17 Valve Driver. The slot number represents the module location in the Instrumentation Bus of the digital controller.

In a single-channel system, module location 14 (slot 14) is used. Each additional channel is added to the left of module location 14 (slot 13, 12, 11).

The prompt is repeated for each of the control channels you entered in step 1.

---

**Step 7 If necessary, enable the CE compliant feature**

The setup program displays the prompt:

**Does this control channel need to be CE (European Community) compliant?**

Each control channel can have a CE compliant control mode for specimen installation.

TestStar implements this feature by providing 10 units per second for Pod control modes. To be properly CE compliant, you must create a length/pod control mode. This control mode is fixed at 10 mm/sec.

---

## Step 8 Identify the manifold configuration

The setup program displays the prompt:

### Select the associated hydraulic service manifold [HSM] configuration for channel x.

The configuration selections represent the control capabilities of the hydraulic service manifold (HSM or actuator manifold). In multiple channel configurations, a single HSM may control one or more actuators.

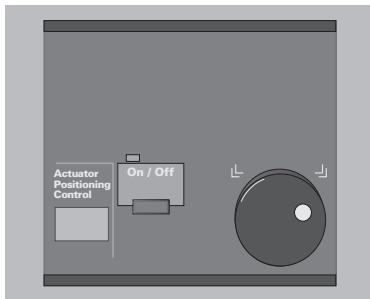

**None**

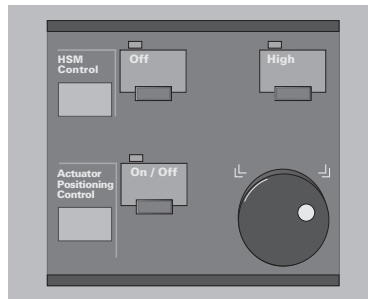

**2-state HSM Control**

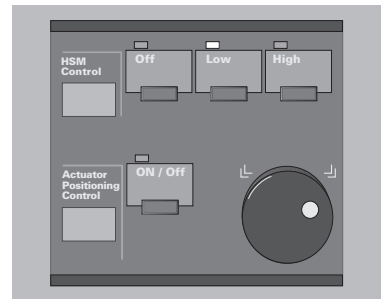

**3-state or Proportional Control**

Compare the number of actuator position controls with the number of HSM Control switch sets to determine if an HSM is shared.

- ◆ If you do not have a hydraulic service manifold for the channel, select **No Manifold**. Then identify how the hydraulic pressure to the channel is controlled. The setup program displays the prompt:

### Select the master HSM for this channel.

For a single-channel system, select

**HPS - Hydraulic Power Supply.**

For a multi-channel system, select

**HSM of Channel # (1 - 4).**

- ◆ If your manifold can be turned on and off only, select **2-state**.
- ◆ If your manifold can apply low hydraulic pressure, high hydraulic pressure, and be turned off, select **3-state** (cable assembly number 397055-xx).

*Continued...*

**Step 8 (continued)**

- ◆ If your manifold has proportional capabilities (cable assembly number 426645-xx) such as ramping to low pressure and ramping to high pressure, select **proportional**. The proportional selection produces the following prompts to define the desired proportional characteristics:

Please enter the proportional valve LOW RATE [off to low] in seconds [0 - 480].

Please enter the proportional valve HIGH RATE [low to high or high to low] in seconds [0 - 480].

Please enter the proportional valve LOW pressure level in percent of high pressure [0 - 95].

**Multiple channels**

Repeat steps 4 through 8 for each control channel.

**Step 9 Select a comm port for a temperature controller**

The setup program displays the prompt:

**Select the Comm Port where the Temperature Controller is located. If the system does not have a Temperature Controller, click on None then Next.**

- ◆ If you do not have a temperature controller, select **None**.
- ◆ If you do have a temperature controller, select **Communication Port 1** or **Communication Port 2**. Selecting a comm port produces the following prompts to define the temperature controller interface.

The communication port is the computer serial port that the temperature controller is connected to. Refer to your computer documentation to identify the rear panel connectors.

A Select the correct baud rate.

Be sure that you select the same baud rate that your temperature controller is set to. Refer to the product manual or the Setup Configuration drawing for your temperature controller.

*Continued...*

**Step 9 (continued)**

- B Select the correct temperature controller.  
Select the controller you have.

**Note** *The Barber-Colman and Eurotherm Temperature Controllers also produce a prompt for you to select the units for the controller.*

- C Please enter the address of the temperature controller.  
Temperature controllers supplied by MTS Systems Corporation are set to address 0. Refer to the product manual or the Setup Configuration drawing for your temperature controller.

- D Please enter the maximum temperature of the controller in degrees Celsius.

Enter the maximum temperature that your furnace or environmental chamber can accommodate.

- E Please enter the minimum temperature of the controller in degrees Celsius.

Enter the minimum temperature that your furnace or environmental chamber can accommodate.

**Note** *You must run the COMTEST.EXE program (located in the TS2 directory) to enable the temperature ramp rate feature. This program also displays if the temperature controller supports a ramp rate. See [page 179](#).*

---



**Step 10 If necessary, set up the acceleration compensation option**

The setup program displays the prompt:

**Does this system have an Acceleration Compensation board?**

**Note** *The acceleration compensation option is a factory installed option. If the acceleration compensation option is present, rear panel BNC connectors labeled Accel are mounted to the Auxiliary I/O panel.*

◆ If you do not have an acceleration compensation board, select **No**.

◆ If you do have an acceleration compensation board, select **Yes**. Selecting yes produces the following prompts to define the acceleration compensation option.

A Enter the Acceleration Compensation board slot location.

The Acceleration Compensation module (Model 490.26) is usually installed in slot location number 10.

B Enter the number of input channels connected to the board.

Check the number of rear panel BNC connectors labeled Accel mounted to the Auxiliary I/O panel. This determines how many acceleration compensation channels are to be defined.

C Enter the slot number connected to the acceleration channel.

The convention for acceleration compensation channels are:

Channel 1 = Load 1

Channel 2 = Load 2

Channel 3 = Load 3

Channel 4 = Load 4

D Specify the polarity of the accelerometer. Select **Yes** if the polarity is normal or if you do not know the polarity. Select **No** if it is inverted.

When the installation is complete, go to Chapter 4 in the Reference manual to adjust the acceleration compensation circuit. If you need to change the polarity, you can return to this question and change the default setting.

E Repeat C and D for each acceleration compensation channel.

---

## Task 6 Installing Additional Applications

---

This task allows you to install additional applications and complete the Setup program.

**Note** *If you install additional applications later, you will need to follow the installation procedure provided in each application manual.*

A The setup program displays the prompt:

**Do you have any applications to install?**

- ◆ Select **Yes** if you have any additional applications.
- ◆ Select **No** if you do not have any optional applications and proceed to Task 7.

B The setup program displays the prompt:

**Please enter the application disk.**

- ◆ Each application disk has an installation program that operates within the Setup program.

C The setup program will display appropriate prompts or information for the selected application.

D The setup program then displays the prompt:

**Do you have any other applications to install?**

- ◆ Select **Yes** to install another application.
- ◆ Select **No** if you do not want to install another application.

E Repeat B through D for each application you want to install.

---

## Task 7 Completing the Software Installation

---

### Reboot the computer

The setup program displays the prompt for the initial installation:

**You need to reboot your computer if changes were made to the CONFIG.SYS or STARTUP.CMD files.**

If you installed the TestStar software for the first time, select Shutdown from the desktop menu, then reboot your computer when the shutdown is complete.

#### CAUTION

**Misuse of the software can cause damage or destroy data on the computer's hard disk.**

**Always** use the **Shut down** selection from the OS/2 desktop menu before turning off computer power (press the right mouse button when no object is selected to display the Desktop menu).

If you get impatient and turn off power before the computer finishes its shut down sequence, data may be lost or you may need to reinstall programs (possibly the operating system itself).

### If you have a temperature controller

After you've shut down and rebooted your computer, you can run COMTEST.EXE to determine if your temperature controller supports the ramp feature of the TestWare-SX temperature control process. The program also enables the ramp feature.

- A Open an OS/2 window.
  - B Go to the TestStar directory (specified in Task 2, Step 1). Type:
 

```
CD C:\TS2
```
  - C Start the COMTEST program. Type:
 

```
comtest
```
  - D The program identifies if your temperature controller supports the ramp feature. If it does, it is enabled. When the program is done, close the OS/2 window (type: **exit**).
-

# Moving TestStar V3.1 Files to TestStar V 4.0

---

The OS/2 Upgrade Assistant is a software package that helps you identify important TestStar 3.1 files so you may use them in version 4.0A of TestStar. The OS/2 Upgrade Assistant contains the Upgrade Assistant program disk and several blank disks.

**Note** You should run the Upgrade Assistant program before you attempt to install Version 4.0 of TestStar.

The Upgrade Assistant program provides the following features:

- ◆ It identifies the current TestStar hardware settings so you can duplicate them when installing TestStar V4.0A.
- ◆ It prompts you to insert a disk to backup the following files:
  - The EXT\_DB.DB file contains external sensor calibration data.
  - The SENS\_DB.DB file contains internal sensor calibration data.
  - The SYSCAL.DB file contains the calibration data for the digital controller.
  - The SYSCALEX.DB file contains the calibration data for the digital controller.

The program produces a report recording the current hardware settings and identifies any files you may want to transfer to the new version of TestStar. The report identifies the following types of files for transfer:

The Upgrade Assistant program does not automatically back up any of these files.

- ◆ TestStar configuration files (.TCC)
- ◆ TestWare-SX templates (.000)
- ◆ TestWare-SX procedures (*template name.###*)—these require the associated template
- ◆ TestWare-SX data files (.DAT)
- ◆ Special files for optional TestWare-SX processes (.DRV, .UDA, etc.)
- ◆ Unit Assignment Sets (.UAS)

Be sure you back up all the files you may want before you change your computer to the Windows NT operating system.

---

## Using the Upgrade Assistant Program

---

Perform the following procedure to identify important files for backup.

1. Double-click the Drive A icon on the desktop. This opens a window showing the icons of the files on the disk.
2. Double-click the ASSIST.EXE icon to start the Upgrade Assistant program.
3. If the program detects network drives, it will ask if it should look in those drives for the TestStar directory. The default location for the TestStar directory should be on the C or D drive.
  - Type **N** if the TestStar directory is not on a network drive or if you are not sure where the TestStar directory is located.
  - Type **Y** if the TestStar directory is located on a network drive.

The program begins to scan the appropriate drives looking for all TestStar directories. The results are listed.

4. The program asks you to enter the number of the TS directory you want the program to analyze.

Usually one listing will be shown C:\TS2\ or D:\TS2\. Type 1 and press Enter.

5. The program asks you to remove the program disk and insert the "OS/2 Sensor Backup" disk supplied with the upgrade package (a blank disk will also work).

The program copies the required files to the disk.

6. The program creates a file (UPGRADE.TXT) listing the current TestStar hardware settings and file transfer recommendations. When this is completed, the program ends.

Drag the UPGRADE.TXT file to the printer on the desktop.

7. Use the printed copy of the UPGRADE.TXT file to determine what files you want to transfer. Use the extra disks supplied with the package to copy any file you decide you need.

# Installing TestStar V4.0

---

The following procedure describes how to install TestWare version 4.0A. This version of TestStar is for Microsoft® Windows NT® version 3.51.

---

## Before you begin

Locate the following disks:

- ◆ The TestStar System Software CD ROM or floppy disks.
  - ◆ The System Calibration disk includes the calibration data for the Analog I/O module. This disk may include sensor calibration data for sensors calibrated at MTS Systems Corp. This disk is only needed for the initial installation.
  - ◆ Read the README.TXT file for late-breaking information that may not be included in the manuals.
- 

## Read the readme file

TestStar system software generally includes a README.TXT file that contains late-breaking information not included in TestStar manuals. If the file is included, it should be opened and the information reviewed before installing the system software. The file is located on the CD ROM or Disk 1 of the floppy disk set.

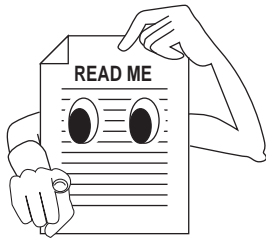

**Note** You can read the readme file now, or you will have the opportunity to read it while installing the software.

To read the file, use the File Manager to see the contents of the CD ROM (usually drive D) and double-click the README.TXT file; or, open a command prompt and enter the following command:

**TYPE D:\INSTALL\DISK1\README.TXT | MORE**

(assuming drive D is the CD ROM)

**TYPE A:README.TXT | MORE**

(reading the file from a floppy disk)

Press any key to display the next page of the file. Press ^C (cntl + C) to exit the file.

---

## Prerequisites

We assume that the Windows NT version 3.51 operating system is properly installed in your computer. We also assume you have turned your computer on and have Windows NT running.

- ◆ You must be logged onto Windows NT as a user with administrator privileges.
  - ◆ You must have Service Pack 4 or newer installed before you can install TestStar 4.0.
- 

## Know your system

You need to know the following information to complete the initial installation:

- ◆ Hydraulic pump configuration (none, on/off, or off/low/high)
  - ◆ Hydraulic service manifold configuration (none, on/off, off/low/high, or proportional)
-

## Abbreviated Procedure

---

### Task 1 Starting the Software Installation Program 185

1. Start the software installation program 185
2. Note about the readme file 185
3. Select the Setup Program's Operational Mode 185

### Task 2 Defining the Software Parameters 186

1. Enter the TestStar directory path 186
2. Select a program folder 186
3. Select the default engineering units 187
4. Select the TestStar language 187

### Task 3 Defining any Options 188

1. Do you have data acquisition option 188
2. Do you have static cross coupling 189

### Task 4 Defining the Hardware Configuration 190

1. Select the system configuration 190
2. Identify the pump configuration 190
3. Enter the number of control channels 191
4. Enter the module location of the Valve Driver 191
5. If necessary, enable the CE compliant feature 192
6. Identify the manifold configuration 192
7. Select a comm port for a temperature controller 194
8. If necessary, set up the acceleration compensation 195

### Task 5 Completing the Software Installation 196

1. Install any calibration files 196
  2. If you have a temperature controller 197
  3. Install any additional software 197
-



## Task 1 Starting the Software Installation Program

---

### Step 1 Start the software installation program

The software installation program is called setup.exe. Perform the following:

- A Insert TestStar CD ROM disk in a CD ROM drive.  
Or, insert Disk 1 in the floppy drive.
- B Double-click the Drive icon assigned to your CD ROM.  
Or, double-click the Drive A icon.
- C Double-click the SETUP.BAT icon (on the CD ROM). Or double-click the SETUP.EXE icon (on the floppy). This starts the software installation program.

**Note** After the initial installation you can run the setup program to change hardware or software settings from the TestStar program group. See Step 3 below.

---

### Step 2 Note about the readme file

The installation program asks if you have read the readme file.

- ◆ Select **Yes** to continue the installation procedure.
- ◆ If you select **No**, the readme file will be displayed. When you have finished reading the file, close the window to continue the setup program.

Page 182 of this chapter has more information about the readme file.

---

### Step 3 Select the Setup Program's Operational Mode

When installing TestStar, the only operational mode is “**Install TestStar II 4.0A**”.

After the initial installation, you can run TestStar Setup from the TestStar program group to change hardware or software settings. Two modes are available from this setup program that run appropriate parts of the installation program.

- ◆ **Change Software Parameters**
- ◆ **Change Hardware Parameters**

Press **Next** to continue.

---

## Task 2 Defining the Software Parameters

---

### Step 1 Enter the TestStar directory path

The setup program displays the following prompt:

**Setup will install TestStar II 4.0A in the following directory.**

The default location— C:\TS2 is shown in the entry field. If you want a different location, use the Browse feature to choose a different location

Press the **Next** button to proceed.

---

### Step 2 Select a program folder

The setup program will install all of the TestStar program icons in the selected program folder.

By default, the setup program will create a program folder called “TestStar” as shown in the entry field. The setup program also displays a list of all your program folders in the event you want to run TestStar from one of those program groups. You have the following options:

- ◆ Accept the default TestStar folder.
- ◆ Rename the default TestStar entry to create a new program folder.
- ◆ Select one of the existing program folders.

Press the **Next** button to proceed.

---

### Step 3 Select the default engineering units

The setup program displays the prompt

**Select the default Unit Assignment Set you wish to use.**

Default engineering units are initially assigned to each TestStar parameter. You can then change the units for any individual parameter or create an entire set of new default units.

◆ Select **SI Units** (metric) or **U.S. customary**.

**Note** *The default engineering units can be changed using the Unit Assignment Set Editor.*

Press the **Next** button to proceed.

---

### Step 4 Select the TestStar language

The setup program displays the prompt

**Select the language you wish to use for TestStar II 4.0A and its applications.**

◆ English

◆ German

◆ French

Press the **Next** button to proceed.

---

## Task 3 Defining any Options

---

The TestStar system software needs to know the capabilities of the hardware components of your system.

---

### Step 1 Do you have data acquisition option

The Extended Analog I/O option and the High Speed Data Acquisition option both use the open machine control board location (slot 19 in the digital controller, see *Machine control modules* on page 49). Only one option may be installed at a time. The setup program displays the prompt:

#### Choose the data acquisition hardware option installed.

- ◆ Select **Normal** if you do not have either hardware option.
- ◆ Select **Extended AIO Card** if connectors J63 and J64 are installed and a second Model 790.40 Analog I/O board installed in slot 19. This option adds 16 external analog inputs to the system.
- ◆ Select **High Speed Data Acquisition Board** if the **High Speed Data Acquisition** board is installed in slot 19 of the digital controller. This option allows data collection at a rate of 70 KHz. It is required for the Model 790.16 High Speed Data Acquisition process for TestWare-SX.

Press the **Next** button to proceed.

---

## Step 2 Do you have static cross coupling

**Note** This step is skipped unless you have the High Speed Data Acquisition board.

The setup program displays the prompt:

### Is static cross coupling enabled in the system?

**Note** The static cross coupling option is usually set up at MTS. This option is used in high speed systems. It is a software compensation feature and it is available on systems with the High Speed Data Acquisition board. Systems that require this feature are generally installed by MTS personnel.

- ◆ Select **Yes** if you have this option and complete the remainder of this step to define the static cross coupling option.
- ◆ Select **No** if you don't have this option.

If you select have the static cross coupling option, you need to complete the following:

- A Please enter the Cross Coupling Type. Select the appropriate type and press **Next** to proceed.
  - Select **Load/Torque**
  - Select **Geometric**
- B Please enter the number of Cross Coupling Channels (2-3). Enter the number of cross coupled channels and press **Next** to continue.
- C Enter the slot number (1-14) connected to Cross Coupling Feedback (channel number). Enter the module location for the corresponding feedback channel on the digital controller and press **Next** to continue.
- D Please enter the cross-coupling coefficients [0][1] value in a floating point (1.23) format. The coefficient is provided by MTS systems.
 

**Note** The bracketed numbers represent channel numbers. For example, [0] = channel 1; [1] = channel 2; [2] = channel 3.
- E Repeat Steps C and D for each cross-coupled channel.

### TIP:

If you do not know the proper coefficients, accept the default entries.

## Task 4 Defining the Hardware Configuration

---

The TestStar system software needs to know the capabilities of the hardware components of your system.

---

### Step 1 Select the system configuration

TestStar can control servo hydraulic equipment or servo motor equipment. The setup program displays the prompt:

#### Select the power source.

- ◆ Select **Hydraulic** if your system uses hydraulic test equipment.
- ◆ Select **Electro-mechanical** if your system uses servo motor equipment.

**Note** *If Electro-mechanical is selected, all TestStar windows using the word "Hydraulic" will be changed to "Servo motor."*

Press the **Next** button to proceed.

---

### Step 2 Identify the pump configuration

The setup program displays the prompt:

#### Select the hydraulic power supply (HPS) configuration.

The configuration selections represent the control capabilities of the hydraulic power supply (HPS or hydraulic pump). Select the appropriate configuration for the hydraulic configuration.

- ◆ If you do not want the TestStar system to control your pump, select **none** (a jumper plug is required, refer to chapter 3).

**Note** *We recommend you use the Error Detector with this configuration.*

- ◆ If your pump can be turned on and off only, select **2-state**.
  - ◆ If your pump can apply low hydraulic pressure, high hydraulic pressure, and be turned off, select **3-state**.
-

### Step 3 Enter the number of control channels

The setup program displays the prompt:

**Select the maximum number of control channels your current hardware supports.**

The number of control channels represents the number of actuators or Valve Driver modules in your system. The load unit control panel has an Actuator Positioning Control for each control channel.

This diagram shows the control channel locations on the load unit control panel for multiple channel systems.

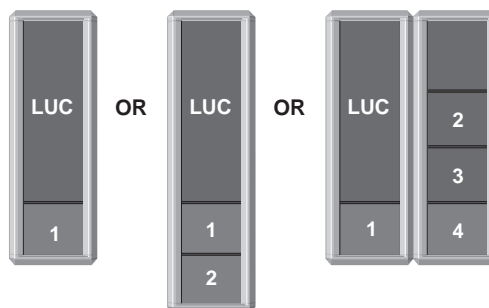

Enter the number of control channels on your system (1 - 4) and press **Next** to continue.

**Note** *If more than one channel is selected, steps 4 through 6 are repeated for each channel. You will be asked to define an HSM for each channel.*

### Step 4 Enter the module location of the Valve Driver

The setup program displays the prompt:

**Please enter the slot number of the valve driver (11-14) for channel x.**

Each control channel requires a Model 490.14 or 490.17 Valve Driver. The slot number represents the module location in the Instrumentation Bus of the digital controller.

In a single-channel system, module location 14 (slot 14) is used. Each additional channel is added to the left of module location 14 (slot 13, 12, 11).

The prompt is repeated for each of the control channels you entered in step 1.

**Step 5 If necessary, enable the CE compliant feature**

The setup program displays the prompt:

**Does this control channel need to be CE (European Community) compliant?**

Each control channel can have a CE compliant control mode for specimen installation.

TestStar implements this feature by providing 10 units per second for Pod control modes. To be properly CE compliant, you must create a length/pod control mode. This control mode is fixed at 10 mm/sec.

**Step 6 Identify the manifold configuration**

The setup program displays the prompt:

**Select the associated hydraulic service manifold (HSM) configuration for Control Channel Number x.**

The configuration selections represent the control capabilities of the hydraulic service manifold (HSM or actuator manifold). In multiple channel configurations, a single HSM may control one or more actuators.

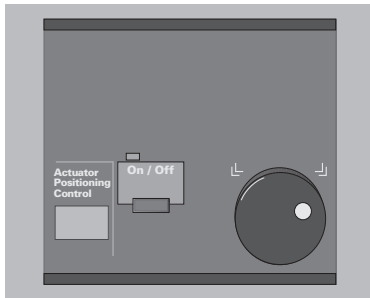

**None**

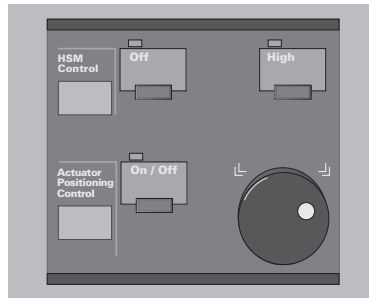

**2-state HSM Control**

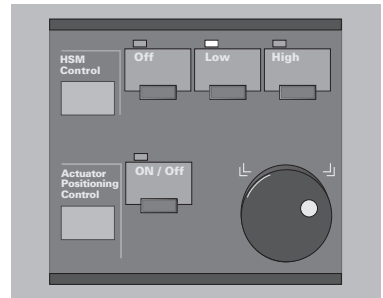

**3-state or Proportional Control**

Compare the number of actuator position controls with the number of HSM Control switch sets to determine if an HSM is shared.

*Continued...*



## Manifold configuration (continued)

- ◆ If you do not have a hydraulic service manifold for the channel, select **No Manifold**. Then identify how the hydraulic pressure to the channel is controlled. The setup program displays the prompt:

### Select the master HSM for Control Channel X

For a single-channel system, select

**HPS - Hydraulic Power Supply**.

For a multi-channel system, select

**HSM of Channel # (1 - 4)**.

- ◆ If your manifold can be turned on and off only, select **2-state**.
- ◆ If your manifold can apply low hydraulic pressure, high hydraulic pressure, and be turned off, select **3-state** (cable assembly number 397055-xx).
- ◆ If your manifold has proportional capabilities (cable assembly number 426645-xx) such as ramping to low pressure and ramping to high pressure, select **proportional**. The proportional selection produces the following prompts to define the desired proportional characteristics:
  - Please enter the proportional valve LOW RATE [off to low] in seconds [0 - 480].
  - Please enter the proportional valve HIGH RATE [low to high or high to low] in seconds [0 - 480].
  - Please enter the proportional valve LOW pressure level in percent of high pressure [0 - 95].

## Multiple channels

Repeat 4 through 6 for each control channel.

## Step 7 Select a comm port for a temperature controller

The setup program displays the prompt:

**Select the Comm Port where the Temperature Controller is located. If the system does not have a Temperature Controller, click on None then Next.**

- ◆ If you do not have a temperature controller, select **None**.
- ◆ If you do have a temperature controller, select **Communication Port 1** or **Communication Port 2**. Selecting a comm port produces the following prompts to define the temperature controller interface.

The communication port is the computer serial port that the temperature controller is connected to. Refer to your computer documentation to identify the rear panel connectors.

- A Select the correct baud rate.

Be sure that you select the same baud rate that your temperature controller is set to. Refer to the product manual or the Setup Configuration drawing for your temperature controller.

- B Select the correct temperature controller.

Select the controller you have.

**Note** *The Barber-Colman and Eurotherm Temperature Controllers also produce a prompt for you to select the units for the controller.*

- C Please enter the address of the temperature controller.

Temperature controllers supplied by MTS Systems Corporation are set to address 0. Refer to the product manual or the Setup Configuration drawing for your temperature controller.

- D Please enter the maximum temperature of the controller in degrees Celsius.

Enter the maximum temperature that your furnace or environmental chamber can accommodate.

- E Please enter the minimum temperature of the controller in degrees Celsius.

Enter the minimum temperature that your furnace or environmental chamber can accommodate.

### **Note**

*You must run the COMTEST.EXE program at the end of the installation. See [page 197](#).*

**Step 8 If necessary, set up the acceleration compensation**

The setup program displays the prompt:

**Do you have an Acceleration Compensation Module on your system?**

**Note** *The acceleration compensation option is a factory installed option. If the acceleration compensation option is present, rear panel BNC connectors labeled Accel are mounted to the Auxiliary I/O panel.*

- ◆ If you do not have an acceleration compensation board, select **No**.
- ◆ If you do have an acceleration compensation board, select **Yes**.  
Selecting yes produces the following prompts to define the acceleration compensation option.
  - A Please enter the accel compensation module slot location.  
The Acceleration Compensation module (Model 490.26) is usually installed in slot location number 10.
  - B Please select the number of accelerometer feedbacks connected to the module.  
Check the number of rear panel BNC connectors labeled Accel mounted to the Auxiliary I/O panel. This determines how many acceleration compensation channels are to be defined.
  - C Please enter the slot number connected to the accelerometer feedback x.  
The convention for acceleration compensation channels are:  
Channel 1 = Load 1  
Channel 2 = Load 2  
Channel 3 = Load 3  
Channel 4 = Load 4
  - D Specify the polarity of the accelerometer. Select **Yes** if the polarity is normal or if you do not know the polarity. Select **No** if it is inverted.  
When the installation is complete, go to Chapter 4 in the Reference manual to adjust the acceleration compensation circuit. If you need to change the polarity, you can return to this procedure and change the default setting.
  - E Repeat Steps C and D for each acceleration compensation channel.

## Task 5 Completing the Software Installation

---

If you are installing TestStar II 4.0A with floppy disks, the setup program will prompt you to insert each disk when needed.

**Note** You may get an error indicating that the WSCI driver didn't start. If this occurs, you may have an interrupt conflict. See [WSCI Jumper Settings vs. Software Settings](#) on page 70.

---

### Step 1 Install any calibration files

The setup program displays the prompt:

#### Choose which Calibration files you want to install

Your system includes calibration disks for each product you purchased with TestStar. Enable each of the calibration files you have.

#### TIPS:

If you have files from TestStar V3.1, you can install them during this step

If you used the Upgrade Assistant (see [page 180](#)), you can use the backup disks with this step.

If you simply backed up the calibration files to a single disk, it can be used with this step.

Any files that need conversion will be converted automatically.

- ◆ Enable the **System Calibration (Analog I/O) File** selection. This is a required file (SYSCAL.DB). It includes the calibration factors for each analog-to-digital and digital-to-analog converter. TestStar will not function properly without it.
- ◆ Enable the **Sensor Calibration Database** section if you had MTS Systems Corporation calibrate your system sensors. The calibration data is for sensors connected to ac and dc conditioners installed in the digital controller (SENS\_DB.DB).
- ◆ Enable the **External Sensor Calibration Database** if you had MTS Systems Corporation calibrate your external sensors. The calibration data is for sensors connected to external ac and dc conditioners from the digital controller (EXT\_DB.DB).
- ◆ Enable the **Extended AIO Calibration Database** if you had MTS Systems Corporation calibrate your sensors. It includes the calibration factors for each analog-to-digital and digital-to-analog converter in the second Model 490.40 Analog I/O board (SYSCALEX.DB)

Pressing the **Next** button will prompt you for a calibration disk for each enabled selection.

---

## Step 2 If you have a temperature controller

After setup is finished, you can run COMTEST.EXE to determine if your temperature controller supports the ramp feature of the TestWare-SX temperature control process. The program also enables the ramp feature.

- A Open the TestStar program folder and double-click the TestStar icon. TestStar must be running before COMTEST can be run.
  - B When prompted to log in, enter mts for both the username and password.
  - C Open a command prompt.
  - D Go to the TestStar directory (specified in Task 2, Step 1). Type:  

```
CD C:\TS2
```
  - E Start the COMTEST program. Type:  

```
comtest
```
  - F The program identifies if your temperature controller supports the ramp feature. If it does, it is enabled. When the program is done, close the command prompt (type: **exit**).
- 

## Step 3 Install any additional software

If you have any optional TestWare software, go to its product manual to install those products separately. Each software option is installed with its own setup program.

If you are upgrading TestStar, you may want to install any files you backed up. You will need to copy your backup files to appropriate TestStar subdirectories.

---





# *TestStar™ II*

Control System

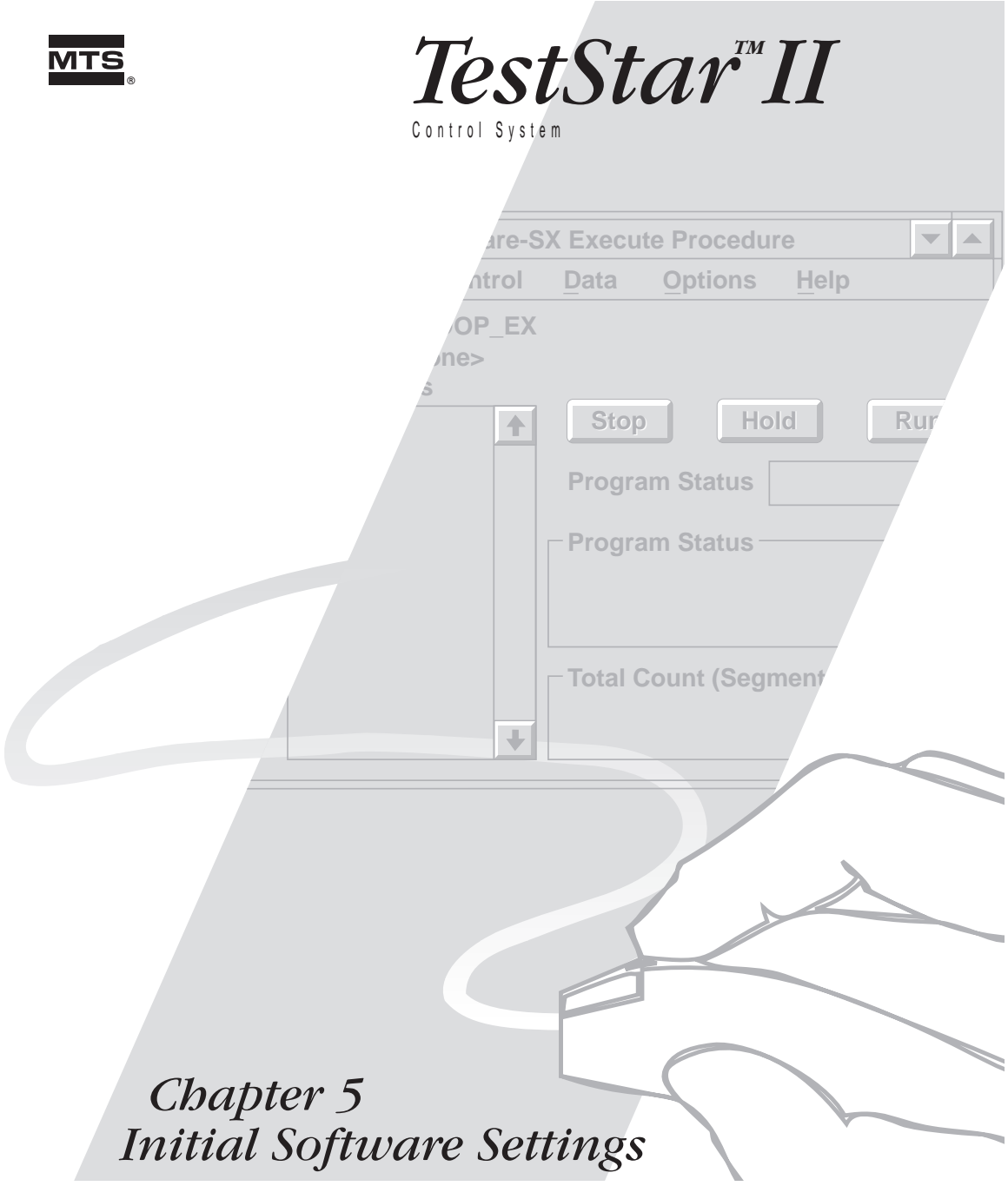

## *Chapter 5 Initial Software Settings*

**Edit Input Signals**

Signal Selection  
Slot 1 - 14 / Calculation

Signal Definition

Signal Name:

Signal Type:

Dimension:

Display Units:

Signal Label:

- AC Conditioner
- DC Conditioner
- External
- Calculation

**Edit Output Signals**

Signal Selection  
Output 1-6

Signal Definition

Signal Name:

Signal Type:

- Analog
- Readout
- Programmable

**Edit Control Channels**

Control Channel Selection  
Control Channel 1

Control Channel Definition

Channel Name:

Channel Type:

Channel Label:

Drive Type:

Phase/Amplitude (PAC):

**TestStar**

File Edit Adjust Display Help

HP

Input Signals

Output Signals

Control Channels

Control Modes

Calculation Constants

Detector Actions

Load Path Stiffness

LUCP Display

Toolbar

Meters

Scope

am State: off/on

**Edit Control Modes**

Control Channel Selection

Control Mode Selection

Control Mode Definition

Mode Name:

Mode Type:

Mode Label:

PIDF Mode Definition

Command Source:

Feedback:

External Source:

- PIDF
- CLC
- CASC

**Edit LUCP Display**

Pane Selection  
TestStar Panel 1

Available Items

Input Signal Header

Control Channel Header

Blank 1

Blank 2

Blank 3

Blank 4

Blank 5

input signal names

control channel names

Selected Items

Enabled Pane Display



## System Administration



## Chapter 5

# Initial Software Settings

---

This chapter describes how to establish the initial software settings for a TestStar system. Not all software settings are described, only those you need to get through the Installation manual.

**Note** *We will be defining an axial/torsional (biaxial) system to illustrate how to create the initial software setting. Use this chapter as a guideline for your software settings.*

This chapter does not explain any of the window controls, see the Reference Manual for detailed descriptions of any controls you want to know more about.

---

### Contents

Abbreviated Procedure	203
Opening any TestStar Application	204
Defining Input Signals	206
Defining Control Channels	209
Defining Control Modes	210
Defining Output Signals	213
Creating User Names	216
Defining the Load Unit Control Panel Display	219
Saving a TestStar Configuration	221

---

## Abbreviated procedure

The abbreviated procedure provides a concise sequence of the initial software settings procedure for those who are experienced using TestStar II.

The abbreviated procedure lists the tasks and steps of the procedure. Each step includes the page number of the detailed procedure where the step is fully explained.

---

## Detailed procedure

The detailed procedure provides an enhanced sequence of the initial software settings procedure for those who are inexperienced using TestStar II.

The detailed procedure is a step-by-step procedure arranged by tasks. Each task is a general group of steps. Each step includes detailed information as to how to complete the step. Some steps include examples or helpful information.

---

## Adapting these procedures for your system

The procedures in this chapter were written from the viewpoint of a “typical” biaxial (2-channel) system having the following:

- ◆ one force sensor
- ◆ one displacement sensor,
- ◆ two strain sensors (from a biaxial extensometer)
- ◆ one torque cell
- ◆ one rotational sensor

The procedures in this chapter apply to any system. The only difference between a single channel system and a multiple channel system is the number of control channels (and their control modes) that must be defined using the Edit Control Channels window.

Modify your procedures as necessary to apply to your system.

---

# Abbreviated Procedure

---

- Task 1 Opening any TestStar Application 204
    - 1. Open the TestStar folder on the desktop. 204
    - 2. Login as a user 205
  - Task 2 Defining Input Signals 206
    - 1. Identify the sensors connected to the digital controller 206
    - 2. Define an input signal 207
    - 3. Define any additional input signals 208
  - Task 3 Defining Control Channels 209
  - Task 4 Defining Control Modes 210
    - 1. Determine what kinds of control modes you need 210
    - 2. Defining a PIDF control mode 211
    - 3. Define a channel limited channel control mode 212
  - Task 5 Defining Output Signals 213
    - 1. Connect monitor devices to the appropriate rear panel connectors 213
    - 2. Define an analog output signal 214
    - 3. Define a readout output signal 215
  - Task 6 Creating User Names 216
    - 1. Open the System Administrator program 216
    - 2. Add or edit a user name 217
    - 3. Select the TestStar programs the user can access 218
    - 4. Close the System Administrator 218
  - Task 7 Defining the Load Unit Control Panel Display 219
  - Task 8 Saving a TestStar Configuration 221
-

## Task 1 Opening any TestStar Application

This task logs you into TestStar. Each TestStar program may require you to login to TestStar.

### Step 1 Open the TestStar folder on the desktop.

From the OS/2 window, open the TestStar folder, then open the Utilities folder.

- ◆ Opening any of these TestStar programs displays the MTS Login window.
- ◆ Double-click the TestStar icon to open it.
- ◆ On new systems, both the User Name and Password are “MTS.”

#### Version 3.1

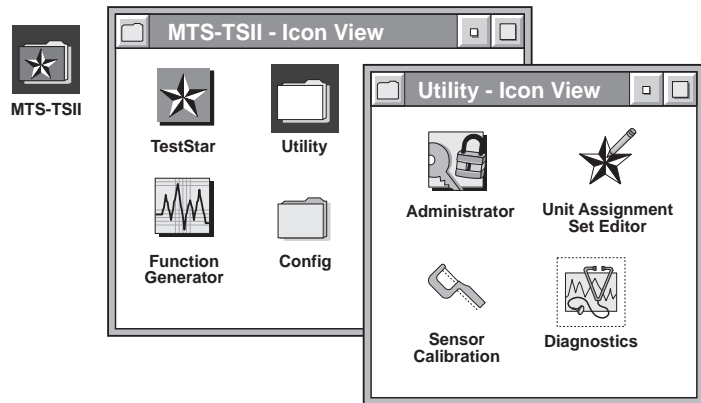

#### Version 4.0

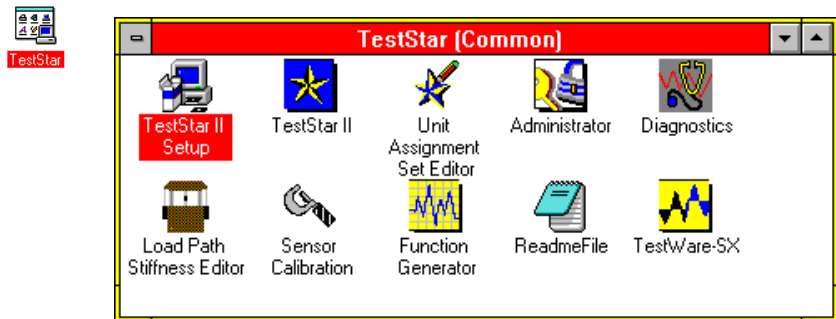

**Step 2 Login as a user**

Type in your user name and password. Press OK when you have completed these two entry fields.

- ◆ The password is not displayed; instead, asterisks are used for password security.
- ◆ The program initializes itself based on the User Name you enter.

**Note** See Appendix E in the Reference Manual for a way to bypass the login procedure.

- ◆ Task 6 describes how to add user names.

**MTS Login**

**TestStar II**

The information and design disclosed herein were originated by and are property of MTS Systems Corporation, and may not be reproduced or disclosed in any form without the written consent of MTS Systems Corporation. MTS Systems Corporation reserves all patent, proprietary, design, manufacturing, reproduction, use and sales hereto and to any article disclosed herein, except to the extent rights are expressly granted to others.

Copyright (c) 1990-1996 MTS Systemss Corporation

Username:

Password:

## Task 2 Defining Input Signals

Defining input signals is needed if this is an initial installation, if you have just added conditioner modules, or if you have changed sensors. This task defines each sensor signal you have connected to your system.

**Note** See Chapter 3 in the Reference manual for detailed information about input signals.

- Procedure**
1. Identify the sensors connected to the digital controller 206
  2. Define an input signal 207
  3. Define any additional input signals 208

### Step 1 Identify the sensors connected to the digital controller

You need to know what kinds of sensors are connected to the digital controller. Each input signal corresponds to a rear panel connector, and each connector is associated with an ac or dc conditioner module.

- ◆ Any sensors to be used for a test should be connected to the rear panel connectors J1 through J14 (along the bottom of the chassis).
- ◆ The rear panel connectors J1 through J14 correspond with input channels (and module locations) 1 through 14 respectively.

*Make sure* that you have accurately tagged or recorded the connections between the rear panel connectors and the sensors. For the purposes of illustration, we will define six input signals for an axial/torsional system as follows:

	AXIAL CHANNEL			TORSIONAL CHANNEL		
<b>Input Signal</b>	LVDT	Load Cell	Axial Extension	ADT	Torque Cell	Torsional Extension
<b>Module Location</b>	1	2	3	4	5	6
<b>Signal Type</b>	AC	DC	DC	AC	DC	DC
<b>Rear Panel Connector</b>	J1	J2	J3	J1	J2	J3

## Step 2 Define an input signal

This step describes how to use the Edit Input Signal window.

- A** Select Input Signals in the Edit menu. This opens the Edit Input Signal window.
- B** Select Slot 1 for the Signal Selection.
- C** Enter any Sensor Name you want—this is the name you will use to identify the input signal. We will use “LVDT” to describe the kind of sensor producing the signal in this example.
- D** Select AC Conditioner as the Signal Type. Since TestStar knows that an AC conditioner is installed in slot 1, it is the only selection (along with none). This displays the Sensor dialog at the bottom of the window.
- E** Select Length as the Dimension. Also select the Display Units you want.

**Note** The Signal Label is automatically set to Length 1. TestStar uses this label internally to identify this input signal in terms of its dimension. The signal **label** is for internal use and signal **name** is for your use.

- F** Press the Assign Sensor pushbutton to select a calibrated length sensor. If you have not calibrated the sensor, select Sensor Calibration.

The Sensor Calibration selection shown here lets you define an uncalibrated sensor so you can use the Sensor Calibration program.

The screenshot shows the 'Edit Input Signals' dialog box. It has a title bar with a dropdown arrow and a close button. Below the title bar is the 'Signal Selection' section with a dropdown menu showing 'Slot 1' and an 'OK' button. The 'Signal Definition' section contains five rows, each with a label and a text field or dropdown: 'Signal Name' with 'LVDT', 'Signal Type' with 'AC Conditioner' and an 'OK' button, 'Dimension' with 'Length' and an 'OK' button, 'Display Units' with '[mm]' and an 'OK' button, and 'Signal Label' with 'Length 1' and an 'OK' button. The 'Sensor' section has a 'Range' label, a dropdown menu showing 'Sensor Calibration', and the unit 'mm'. At the bottom is an 'Assign Sensor' button.

### Step 3 Define any additional input signals

Repeat step 2 for each input signal you want to define.

#### AXIAL INPUT SIGNALS

#### TORSIONAL INPUT SIGNALS

The input signal for the axial LVDT is defined in Step Step 2.

**Edit Input Signals**

**Signal Selection**  
Slot 4

**Signal Definition**  
 Signal Name: ADT  
 Signal Type: DC Conditioner  
 Dimension: Anlge  
 Display Units: [deg]  
 Signal Label: Angle 1

**Sensor**  
 Range: Sensor Calibration deg

Assign Sensor

**Edit Input Signals**

**Signal Selection**  
Slot 2

**Signal Definition**  
 Signal Name: load cell  
 Signal Type: DC Conditioner  
 Dimension: Force  
 Display Units: [N]  
 Signal Label: Force 1

**Sensor**  
 Range: Sensor Calibration N

Assign Sensor

**Edit Input Signals**

**Signal Selection**  
Slot 5

**Signal Definition**  
 Signal Name: torque cell  
 Signal Type: DC Conditioner  
 Dimension: Torque  
 Display Units: [N-m]  
 Signal Label: Torque 1

**Sensor**  
 Range: Sensor Calibration N-m

Assign Sensor

**Edit Input Signals**

**Signal Selection**  
Slot 3

**Signal Definition**  
 Signal Name: extensometer  
 Signal Type: DC Conditioner  
 Dimension: Strain  
 Display Units: [mm/mm]  
 Signal Label: Strain 1

**Sensor**  
 Range: Sensor Calibration mm/mm

Assign Sensor

**Edit Input Signals**

**Signal Selection**  
Slot 6

**Signal Definition**  
 Signal Name: torsional extensometer  
 Signal Type: DC Conditioner  
 Dimension: Strain  
 Display Units: [mm/mm]  
 Signal Label: Strain 2

**Sensor**  
 Range: Sensor Calibration mm/mm

Assign Sensor



## Task 3 Defining Control Channels

You need to know where each servovalve is connected to the digital controller. Each control channel has a valve driver. The following assumes the module location convention described in Chapter 2.

- ◆ For a single-channel system, a valve driver is plugged into module location 14. This is assigned to control channel 1. The servovalve connected to rear panel connector J14 is for the axial actuator.
- ◆ For a multiple-channel system, each valve driver is plugged into module locations 13, 12, and 11. These locations represent control channels 2, 3, and 4 respectively.

*For example*, in an axial-torsional system, control channel 1 is the axial channel and control channel 2 is the torsional channel.

Complete the control channel definition for your system. Be sure to select the proper Drive Type that represents the type of servovalve connected to each valve driver. See Task 4 to define the control modes for each control channel.

**Note** In a multiple-channel system, you can define all of the control channels (including control modes). If a channel is not needed for a test, select none for the Drive Type. This maintains the control channel definition without allocating processing power to the unused channel.

### AXIAL

Edit Control Channels	
Control Channel Selection	
▲ ▼	Control Channel 2
Control Channel Definition	
Channel Name:	tortional
Channel Type:	Controller
Channel Label:	Torsional
Drive Type:	252 Valve
Phase/Amplitude (PAC)	Disabled

### TORSIONAL

Edit Control Channels	
Control Channel Selection	
▲ ▼	Control Channel 1
Control Channel Definition	
Channel Name:	axial
Channel Type:	Controller
Channel Label:	Axial
Drive Type:	252 Valve
Phase/Amplitude (PAC)	Disabled

## Task 4 Defining Control Modes

---

This task describes how to define some control modes. The most common control modes are defined here.

**Note** See the control channel section of Chapter 3 in the Reference manual for detailed information about all the control modes and command sources.

---

- Procedure**
1. Determine what kinds of control modes you need 210
  2. Defining a PIDF control mode 211
  3. Define a channel limited channel control mode 212
- 

### Step 1 Determine what kinds of control modes you need

There are two basic functions for control modes:

- ◆ **Installing a specimen**—this function requires a command source from the Actuator Positioning Control on the load unit control panel. This command source is called **Pod**.
- ◆ **Testing a specimen**—this function requires a command source from the Function Generator program or from an optional TestWare application. This command source is called **SG** (which stands for segment generator).

A typical complement of axial and torsional control modes would consist of the following:

AXIAL CHANNEL	SPECIMEN INSTALLATION			SPECIMEN TESTING		
<b>Mode Type</b>	CLC	PIDF	PIDF	PIDF	PIDF	PIDF
<b>Command Source</b>	Pod	Pod	Pod	SG	SG	SG
<b>Feedback</b>	LVDT/load cell	LVDT	load cell	load cell	LVDT	extensometer

TORSIONAL CHANNEL	SPECIMEN INSTALLATION			SPECIMEN TESTING		
<b>Mode Type</b>	CLC	PIDF	PIDF	PIDF	PIDF	PIDF
<b>Command Source</b>	Pod	Pod	Pod	SG	SG	SG
<b>Feedback</b>	angle/torque	angle	torque	torque	angle	extensometer

## Step 2 Defining a PIDF control mode

This step describes how to define a PIDF control mode for any control channel or command source.

- A** Use the Control Channel Selection to create control modes for the axial or torsional channels. You can create up to ten control modes for each control channel.
- B** Use the Control Mode Selection to define one of the ten control modes.
- C** Type a name for the control mode in the Mode Name entry field.
- D** Select the PIDF Mode Type.
- E** Select a Command Source.
  - SG** is from the Function Generator or TestWare application,
  - Pod** is from the load unit control panel, and
  - Ext** is from an external command source (*see Chapter 10*).
- F** Select one of the input signals you defined in Task 2 for the Feedback selection.

TestStar creates the Mode label automatically. It consists of the feedback dimension, a letter, and the command source.

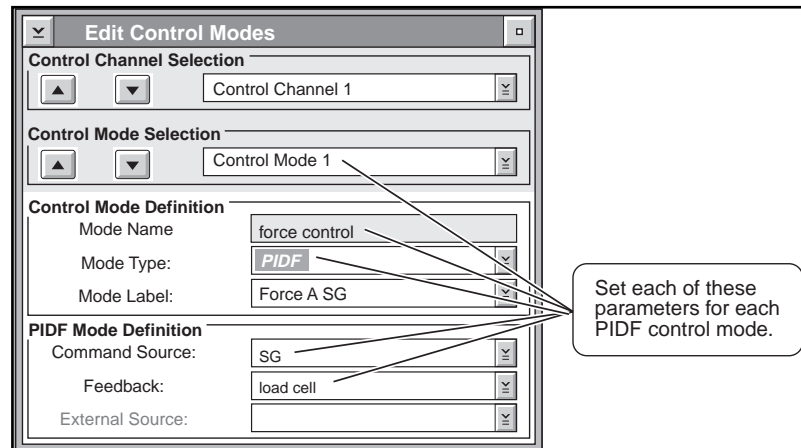

- G** Repeat this step for each PIDF control mode you wish to make.

**Step 3 Define a channel limited channel control mode**

This step describes how to define a channel limited channel (CLC) control mode for any control channel.

- A** Use the Control Channel Selection to create control modes for the axial or torsional channels. You can create up to fifteen control modes for each control channel. Select a control channel
- B** Use the Control Mode Selection to define one of the ten control modes. Select one of the ten control modes.
- C** Type a name for the control mode in the Mode Name entry field.
- D** Select the CLC Mode Type.
- E** Select the **Pod** Command Source (it is the only selection).
- F** Select one of the input signals you defined in Task 2 for the control mode feedback.
- G** Select one of the input signals you defined in Task 2 for the control mode limit channel

TestStar creates the Mode label automatically. It consists of the master feedback dimension, the limit feedback dimension with a letter, and the command source (POD)

Set each of these parameters for each CLC control mode.

- H** Repeat this step for each CLC control mode you wish to make.

## Task 5 Defining Output Signals

This task describes how to define output signals for the rear panel Readout connectors.

**Note** This task is optional. However, if you expect to perform any sensor calibrations or tuning, you will need to define output signals.

See Chapter 3 in the TestStar Reference manual for detailed information about output signals.

### Procedure

1. Connect monitor devices to the appropriate rear panel connectors 213
2. Define an analog output signal 214
3. Define a readout output signal 215

### Step 1 Connect monitor devices to the appropriate rear panel connectors

The six output signals are associated with specific rear panel connectors.

- If you expect to calibrate sensors, connect a DVM to connector Output 1 (J71).
- If you expect to tune, connect an oscilloscope to connector Output 3 (J73).

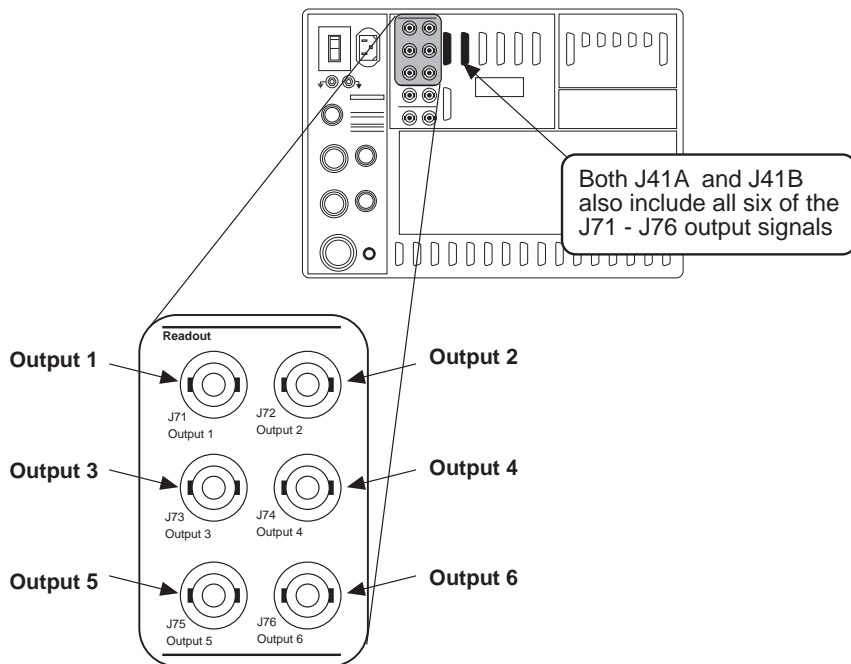

**Step 2 Define an analog output signal**

Perform this step if you plan on using any sensor calibration procedure (Chapters 6 - 8). Sensor calibration requires the use of the analog bus.

- A** From the Edit menu, select Output Signals.
- B** Select Output 1. Only output 1 and output 2 can monitor the analog bus.
- C** Type a name for the output signal in the Output Name entry field.
- D** Select Analog Bus for the Signal Type.
- E** Select the conditioner you want to monitor. The input signal names you defined in Task 2 help identify each conditioner.
- F** Select the Transducer as the Signal you want to monitor.

This window is set up to monitor the LVDT feedback signal.

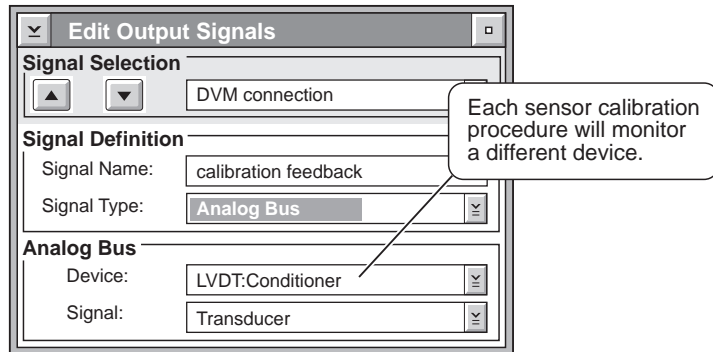

### Step 3 Define a readout output signal

Perform this step if you plan on tuning any control modes (See Chapter 9 in the Reference manual).

- A** From the Edit menu, select Output Signals.
- B** Select Output 3. You can use any of the six output signals for readout.
- C** Type a name for the output signal in the Output Name entry field.
- D** Select Readout for the Signal Type.
- E** Select the conditioner you want to monitor. The input signal names you used in Task 2 help identify each conditioner.
- F** Select the Transducer as the Signal you want to monitor.

This window is setup to monitor the LVDT feedback signal.

See Chapter 3 in the Reference Manual if you want to use the Gain or Offset controls.

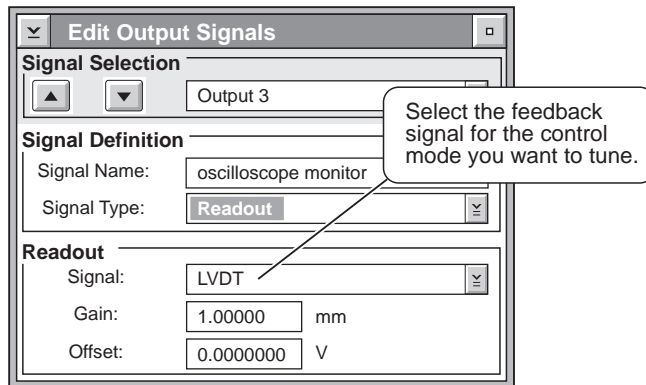

## Task 6 Creating User Names

This task describes how to define user names, their passwords, and what TestStar programs the user name can access.

**Note** *This procedure is optional. However, if more than one person will be using TestStar, you may want to define the system users.*

*See Chapter 7 in the TestStar Reference manual for detailed information about the System Administration program.*

### Procedure

1. Open the System Administrator program 216
2. Add or edit a user name 217
3. Select the TestStar programs the user can access 218
4. Close the System Administrator 218

#### Step 1 Open the System Administrator program

- A** Double-click the MTS-TSII or TestStar icon on the desktop. (OS/2 only) Then double-click the Utility folder.
- B** Double-click the Administrator icon.
- C** You may need to log into the Administrator program. Enter your user name and password in the MTS Login window.

By default, the System Administration window is ready to define a new user name when the program is first started.

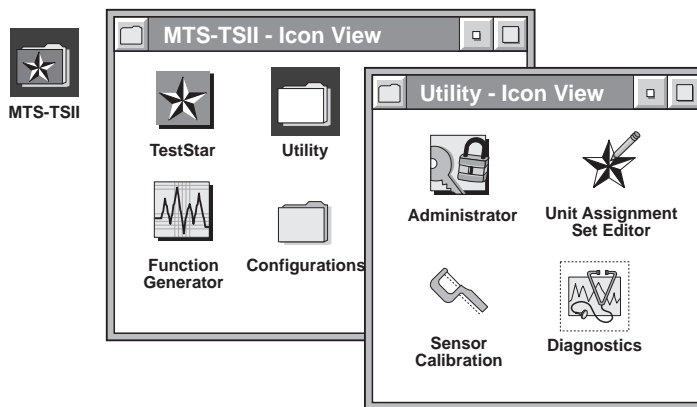



## Step 2 Add or edit a user name

- A Enter or edit the information in the window as shown below. All the fields are mandatory except for the Last name, Middle initial, and First name.
- B When you have completed the window, press the Add pushbutton to bring up the Application Access window.

If you are editing an existing user, press the Edit pushbutton. This also brings up the Application Access window.

The information you enter is not case sensitive.

The New User window and the Edit User window are the same, except for the name of the Add or Edit pushbutton.

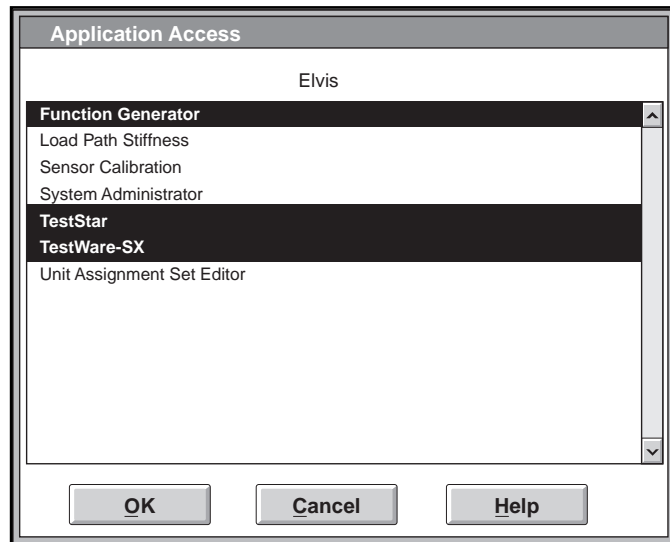

- ◆ The Configuration file name must show the full path for the file's location. In addition, the extension .TCC is required.
- ◆ A configuration file named **none** lets you open TestStar without any selections made. All parameter values and selections are blank. *For example*, the following shows the default path for a configuration file:

**C:\TS2\CONFIG\Elvis.TCC**

- ◆ The Unit Assignment is selected from a list of predefined unit assignment sets.

### Step 3 Select the TestStar programs the user can access

Click (to select) the applications that the user can have access to.

- ◆ This sample user has access to two applications, but cannot use the another four applications.
- ◆ Press OK when done.

*For example, Elvis can open the only Function Generator and TestWare-SX applications.*

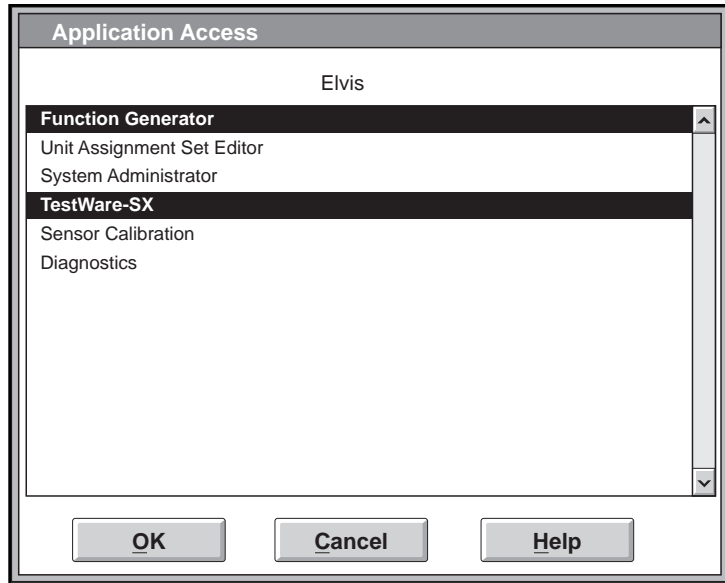

Repeat steps 2 and 3 for each new user you want to create.

---

### Step 4 Close the System Administrator

Close the System Administration program by double-clicking the system menu icon.

---

## Task 7 Defining the Load Unit Control Panel Display

This task describes how to define a display screen on the load unit control panel. You need to know what kinds of signals you want displayed at the load unit control panel. TestStar supports two display panels.

- A Select LUCP Display in the Edit menu. This opens the Edit LUCP Display window.
- B Highlight one of the Available Items in the left column. This item will be located in the top row of the LUCP display screen.
- C Press the right double arrow to move the selected item from the Available Items list to the Selected Items list.
- D Repeat Steps B and C for each item you want shown in the LUCP display. The order the items are listed in the Selected Items list is the same order as they appear in the LUCP display screen.

*For example,* the following show how to configure the two display panels so they show the signals that are defined in this chapter. You can define each display to show any combination of the Available Items.

### Axial

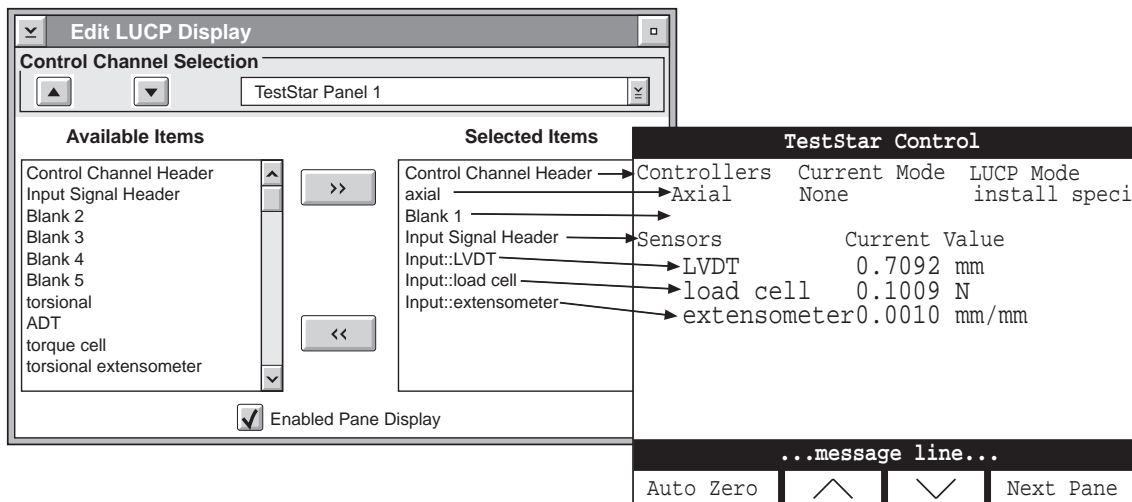

## Defining the Load Unit Control Panel Display (...continued)

### Torsional

**Edit LUCP Display**  
Control Channel Selection: TestStar Panel 2

**Available Items**

- Control Channel Header
- Input Signal Header
- Blank 3
- Blank 4
- Blank 5

**Selected Items**

- Control Channel Header
- Input Signal Header
- Input::ADT
- Input::torque cell
- Input::torsional extensometer

Enabled Pane Display

**TestStar Control**

Controllers	Current Mode	LUCP Mode
torsional	None	install speci
Sensors	Current Value	
ADT	0.0092 deg	
torque cell	0.1009 N-m	
torsional extensometer	0.1020 mm/mm	

...message line...

Auto Zero    ^    v    Next Pane

## Task 8 Saving a TestStar Configuration

---

This task describes how to save the configuration you created in this chapter. The following procedure assumes TestStar (TS2) directory is on the C: drive and that your config directory is in the TS2 directory.

- A** Select Save in the File menu. This opens the Save as window.
- B** The Save as window should be configured for the subdirectory specified in Step 4, Task 3 of the Software Installation chapter.
  - ◆ Drive: = C:
  - ◆ Directory = TS2 and config should be open
- C** Enter a file name for your configuration.
- D** Press the OK pushbutton to save the file.

Here, the initial software settings are called default.TCC.

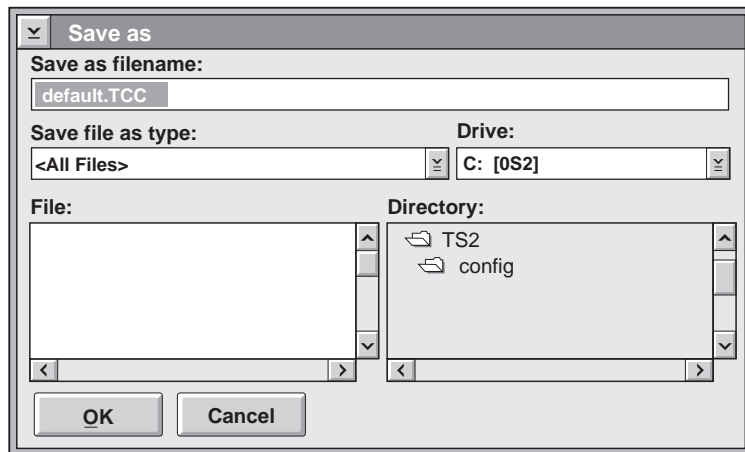





# TestStar™ II

Control System

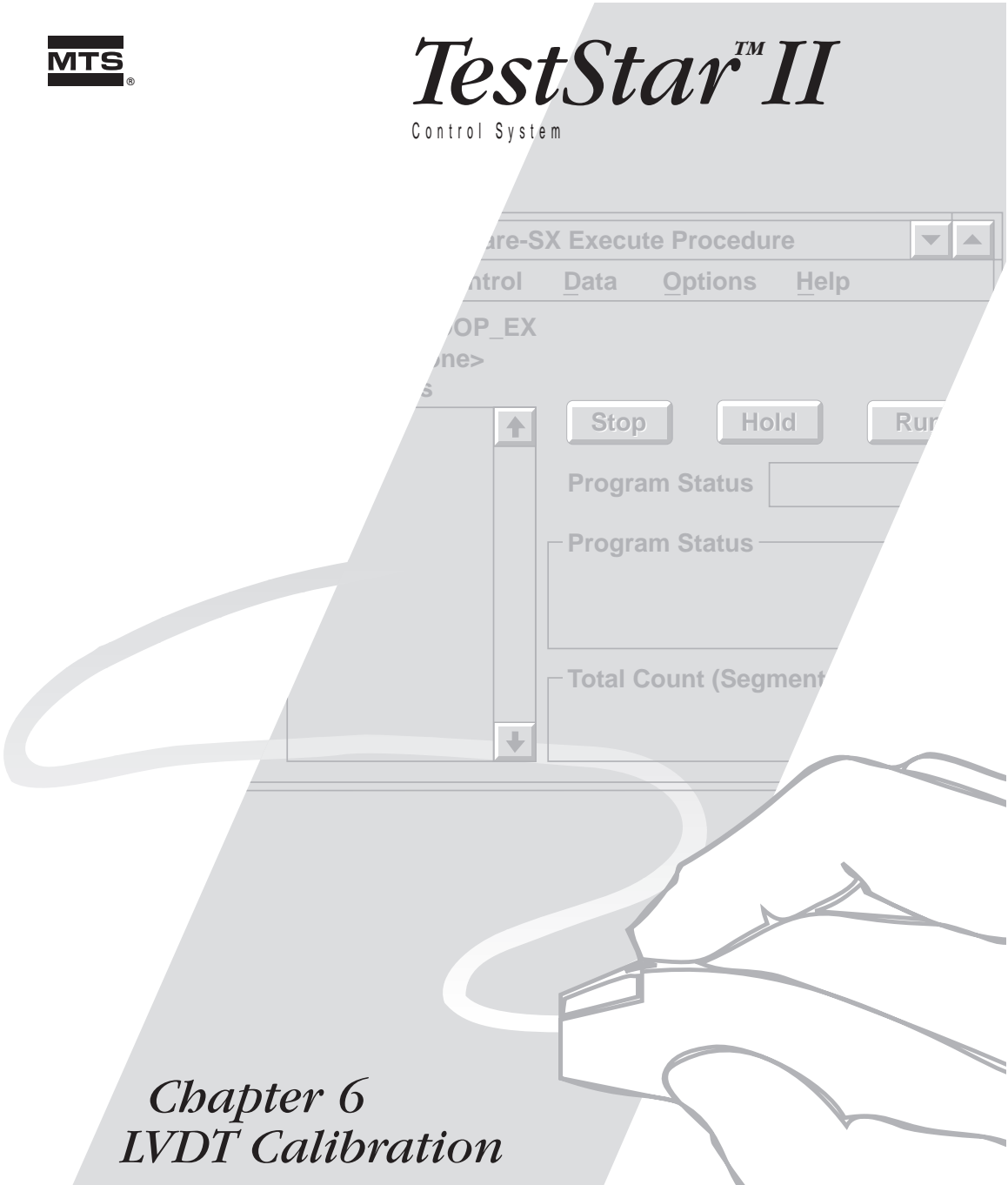

## Chapter 6 LVDT Calibration

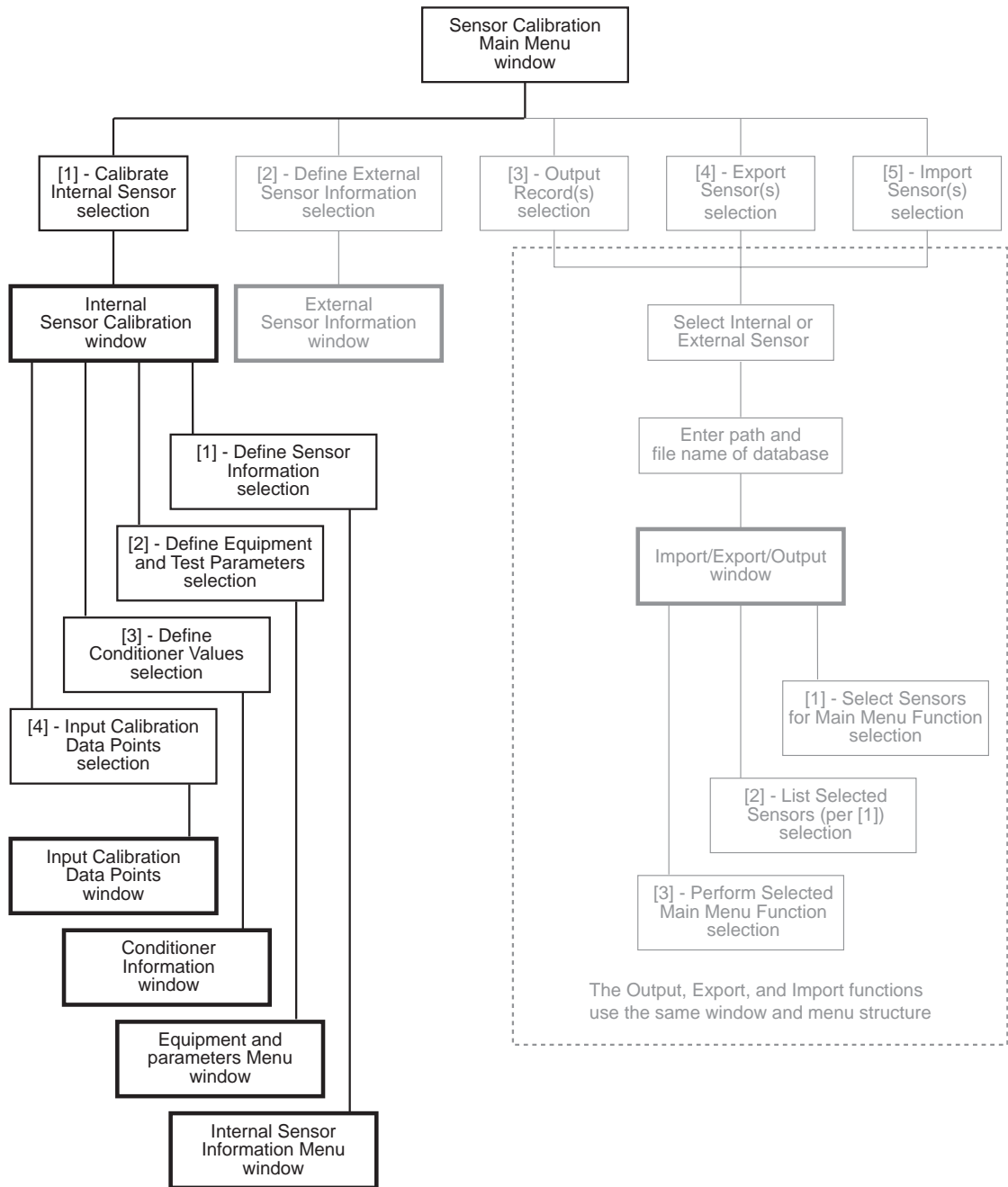



## Chapter 6

# LVDT Calibration

---

This chapter describes how to calibrate an LVDT (linear variable differential transformer) for use with TestStar. Use this procedure as a guideline for other sensors that require an AC conditioner.

### Important

**When you finish using the Sensor Calibration program, be sure to shutdown TestStar, then restart it.**

The Sensor Calibration program disables all the TestStar interlocks. TestStar must be restarted to re-establish the interlock systems.

### Contents

General Information 193

Abbreviated Procedure 227

Detailed Procedure 229

---

### What you will need

You will need the following items to calibrate an LVDT:

- ◆ An dial indicator gage
  - ◆ A digital voltmeter (DVM)
- 

### Prerequisites

When you start the LVDT calibration, the following must be true:

- ◆ The LVDT is properly installed in the load unit.
  - ◆ You have logged onto the TestStar application.
  - ◆ Electrical power is applied to the digital controller for at least 30 minutes before you start the procedure.
  - ◆ You have defined an input signal for an AC Conditioner.
  - ◆ You have defined a control mode using the LVDT input signal and Pod command source.
-

## Sensor calibration program

The LVDT calibration procedure creates a calibration data base for each range of a new sensor. Use the Sensor Calibration program to recalibrate an LVDT periodically.

---

## What are calibration data base records?

A calibration data base record is a file that contains information about a calibrated sensor. Each data base record is the calibration information for a single range of a sensor. The data base that is created includes the following:

- ◆ Sensor information (model, type, serial number, calibration date)
  - ◆ Equipment information (identifies the equipment used in the calibration)
  - ◆ Conditioner information (serial number, model number, excitation voltage, circuit parameters)
  - ◆ Calibration data points
- 

## Abbreviated procedure

The abbreviated procedure provides a concise sequence of the calibration procedure for those who are experienced at calibrating sensors with TestStar.

The abbreviated procedure lists the tasks and steps of the calibration procedure. Each step includes the page number of the detailed procedure where the step is fully explained.

---

## Detailed procedure

The detailed procedure provides an enhanced sequence of the calibration procedure for those who are inexperienced at calibrating sensors with TestStar.

The detailed procedure is a step-by-step procedure arranged by tasks. Each task is a general group of steps. Each step includes detailed information as to how to complete the step. Some steps include examples or helpful information.

---

# Abbreviated Procedure

---

## Task 1 Getting Things Ready 229

1. Locate relevant documentation 229
2. Open a TestStar configuration file 230
3. Set up to monitor the LVDT signal 230
4. Select a length control mode for the LUC 232
5. Turn on hydraulic power 232
6. Set the actuator to mid-displacement 233
7. Mount the dial indicator to the actuator 233
8. Start the Sensor Calibration program 234
9. Open the internal sensor calibration screen 234

## Task 2 Creating a New Sensor Data Base 235

1. Open the define sensor information screen 235
2. Create or open a data base record 236
3. Enter any optional information for the data base 237

## Task 3 Saving the Data Base 238

## Task 4 Defining the Calibration Equipment 239

1. Open the Define Equipment window 239
2. Define the digital voltmeter 239
3. Define the dial indicator 239
4. Record any additional information 240
5. Return to the main menu 240

## Task 5 Setting Up the Conditioner Information 241

1. Open the Conditioner Information menu 241
2. Set the initial fine gain 242
3. Enter the excitation voltage 242
4. Record the delta K polarity 242
5. Set the conditioner filter 243

6. Select the range gain 243
7. Set the initial ac calibration factor 243
8. Set the initial ac phase 243

#### Task 6 Calibrating Zero 244

1. Open the Zero offset menu 244
2. Adjust the zero value to zero the dial indicator reading 244

#### Task 7 Calibrating Extension 245

1. Exercise the actuator to remove any LVDT hysteresis 245
2. Adjust the ac phase 246
3. Adjust the actuator for a voltmeter reading of -8 volts 246
4. Adjust the fine gain to achieve 80% compression 246

#### Task 8 Calibrating Retraction 247

1. Adjust the actuator to the zero reference 247
2. Adjust the actuator for a meter reading of +8 volts 247
3. Adjust delta K to achieve 80% full-scale tension 248
4. Return to the main menu 248

It didn't work 248

#### Task 9 Recording Data Points 249

1. Record the compression data points 249
2. Record the tension data points 250
3. Enter the data points into the data base. 250
4. Return to the main menu. 250

#### Task 10 Calibrating Additional Ranges 251

1. Determine a new range 253
2. Go back to Task 2 253
3. Complete the calibration and save your work 253

## Task 1 Getting Things Ready

---

This task allows you to prepare things before you need them.

---

### Procedure

1. Locate relevant documentation 229
  2. Open a TestStar configuration file 230
  3. Set up to monitor the LVDT signal 230
  4. Select a length control mode for the LUC 232
  5. Turn on hydraulic power 232
  6. Set the actuator to mid-displacement 233
  7. Mount the dial indicator to the actuator 233
  8. Start the Sensor Calibration program 234
- 

### Step 1 Locate relevant documentation

You need to be able to get information relevant to the calibration procedure. By finding the documentation now, you will be able to complete the calibration procedure without interruption.

- ◆ You need information about the sensor such as the serial number, model number, excitation voltage, displacement (stroke or length), etc. This can be found on the Actuator Identification Plate.
  - ◆ You need the calibration identification numbers and calibration dates for the dial indicator and digital voltmeter (DVM) that will be used for this calibration procedure. The calibration information is typically on a sticker attached to the equipment.
  - ◆ You need the ac conditioner serial number.
-

## Step 2 Open a TestStar configuration file

You need a TestStar configuration with the following minimum requirements:

- ◆ An input signal defined to use the LVDT.

If this is the first time the LVDT is being calibrated, the input signal sensor assignment must use the special Sensor Calibration selection.

If this is recalibration of the LVDT, the input signal sensor assignment must use the existing sensor file.

- ◆ An output channel defined as an analog bus with the LVDT transducer signal selected (if this is not defined, see Step 3)
- ◆ A control channel and at least one control mode defined to use the LVDT feedback with the Actuator Positioning Control (Pod).

Open a configuration file from the TestStar File menu. If you created a TestStar configuration as described in Chapter 5, use that file.

---

## Step 3 Set up to monitor the LVDT signal

This step describes how to set up an output signal to monitor the LVDT signal and where to connect a meter.

- Open the Edit Output Signals window from the Edit menu.
- Set up the window as shown.

The Device name shown is a default name.

If you named your input signal, that name would precede Conditioner.

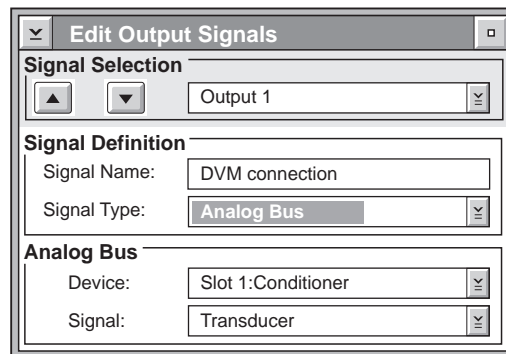

Continued...

**Step 3 (continued)**

- C Connect a meter to the rear panel connector J71 if you defined Output 1 (Analog Bus A). Use J72 if you defined Output 2 (Analog Bus B). You need to know which analog bus is being used for readout later in this procedure (Task 5, step 5).

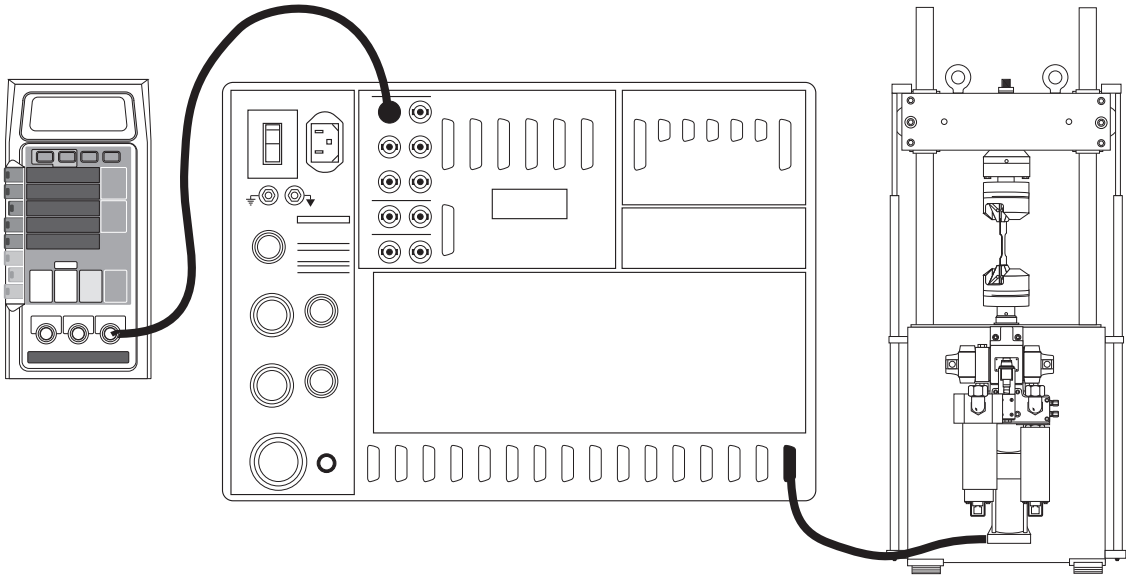

- D Be sure the LVDT cable is connected to a rear panel connector associated with an AC conditioner selected for the LVDT. The front panel module locations 1 through 14 correspond with the rear panel XDCR connectors J1 through J14.

*For example*, module location 1 corresponds with the rear panel connector J1 labeled XDCR 1.

#### Step 4 Select a length control mode for the LUC

A control mode for the load unit control panel is required to use the **Actuator Positioning Control**.

Select the control mode that is defined to use the LVDT as the Next APC Mode.

Press the Actuator Positioning Control switch on the load unit control panel to select the control mode. The name of the Next APC Mode will be displayed as the Current Mode.

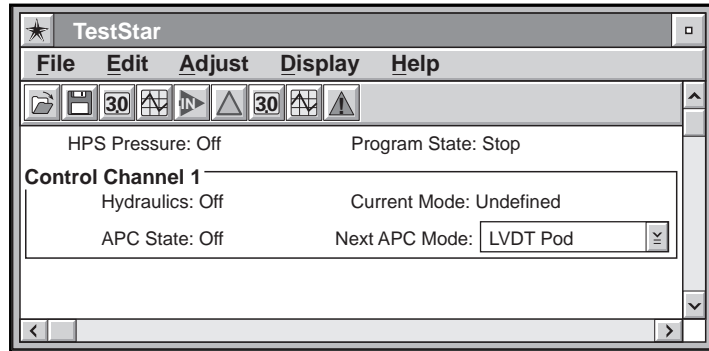

#### **⚠ WARNING**

**Unexpected actuator movement can occur when hydraulic pressure is turned on. This can cause personal injury or equipment damage.**

Read the Safety Precautions in the front of the Operator's Guide before you turn on the hydraulic pressure. The Safety Precautions portion describes hazards that apply to test systems and offers suggestions for avoiding hazards. It is very important that you remain aware of hazards that apply to a test system.

#### Step 5 Turn on hydraulic power

The following controls are located on the load unit control panel.

- A Press the **Interlocks Reset** switch if any interlock indicators are lit. If an indicator does not turn off, you need to correct the interlock before proceeding (refer to the reference manual).
- B Press the **HPS Control Low** switch, then press the **High** switch to turn on the hydraulic power supply.
- C Press the **HSM Control Low** switch, then press the **High** switch to turn on the hydraulic pressure at the service manifold (which applies hydraulic pressure to the actuator).



## Step 6 Set the actuator to mid-displacement

- A Press the **Actuator Positioning Control** switch on the load unit control panel to light the indicator (this enables the APC adjustment control).
  - B Adjust the APC control to fully extend the actuator and note the meter
  - C Adjust the APC control to fully retract the actuator and note the meter reading.
  - D The two meter readings should be within 2% of each other (10 volts, opposite polarities).
    - ♦ If not, a mechanical adjustment to center the LVDT may be necessary (refer to the actuator product manual).
  - E Adjust the APC control to obtain a zero meter reading; this should be the mid-displacement of the actuator.
- 

## Step 7 Mount the dial indicator to the actuator

Mount a dial indicator between the actuator rod and a stationary point such as the load unit platen. Zero the dial indicator.

The illustration shows a dial indicator reading the actuator position.

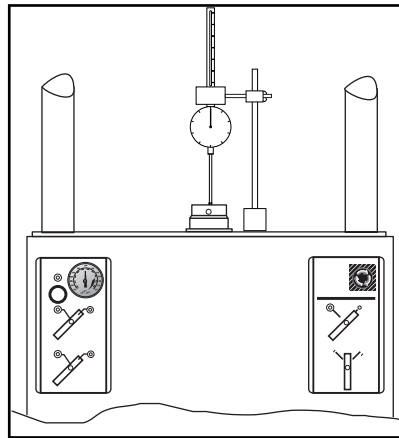

## Step 8 Start the Sensor Calibration program

Open the Sensor Calibration program in the Utilities group. Observe the WARNING when it is displayed, then press Enter.

You should see this window when you open the Sensor Calibration program.

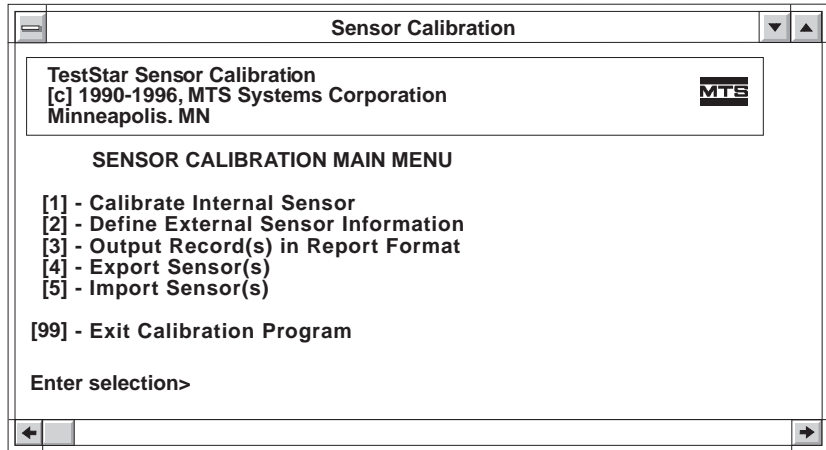

## Step 9 Open the internal sensor calibration screen

Select **[1] - Calibrate Internal Sensor** in the Sensor Calibration Main Menu.

An internal sensor is one that is connected to the rear panel of the digital controller and the sensor is conditioned with a Model 497.13 AC Conditioner or a Model 490.22 AC Conditioner.

The Internal Sensor Calibration window shows 4 functions that are used in this procedure.

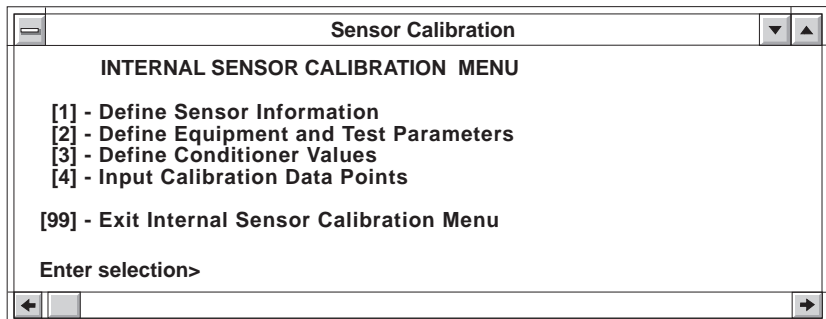

## Task 2 Creating a New Sensor Data Base

---

The information you will need to complete Task 2 can be found on the Actuator Identification Plate mounted on the rear of the load unit or on the actuator itself.

**Note** *Each sensor data base uses the sensor name and range multiplier as the data base name. We recommend you use the sensor's model number for the sensor name. This provides a unique data base record and avoids overwriting an existing data base record.*

---

### Procedure

1. Open the define sensor information screen 235
  2. Create or open a data base record 236
  3. Enter any optional information for the data base 237
- 

#### Step 1 Open the define sensor information screen

Select **[1] - Define Sensor Information** in the Internal Sensor Calibration Menu.

---

## Step 2 Create or open a data base record

**Note** All the entry fields are blank when you first start the program and create a new data base record. Open another data base and use it as a template. This allows you to change only the parameters unique to the sensor you are calibrating. When using a template, remember to save the data base with a different name.

- ◆ If you are calibrating a sensor for the first time, create a new data base record (you may want to open a similar data base as a template).
- ◆ If you are checking the calibration accuracy of a sensor, open the data base record of the sensor.
- ◆ If you are calibrating a new range for a sensor, create a new data base record. When calibrating a new sensor range, use the data base of another range of the same sensor as a template. Also, the exact name of the full-scale sensor must be used.

Select **[1] - Create New DB Record** in the Sensor Information Menu OR select **[2] - Locate Existing DB Record** in the Sensor Information Menu.

You will be prompted to provide the following information about the sensor you are calibrating (or the data base you are opening).

PROMPT	INFORMATION
Dimension	Select <b>[0] - Length</b> . This information is labeled Type on the Actuator Identification Plate.
Name	The Model number of the sensor.
Range	The maximum displacement in one direction from the mid-displacement (half the full displacement or stroke)
Units	The units that define the full-scale length.
Offset	Enter 0 if the offset is unknown (in volts).
Slot	The module location the sensor is connected.
APC	The actuator positioning control channel number (if more than one).

### Step 3 Enter any optional information for the data base

The following is not required for the sensor data base. However, you may want to record important information about the sensor calibration.

MENU	PURPOSE	HELP
5	To record the next calibration date	Select <b>[5] - Next Calibration Date</b> and enter the next date the sensor should be calibrated (typically 1 year between calibrations).
6	To record the sensor's full-scale capacity	Select <b>[6] - Full Scale Capacity</b> and enter the full-scale capacity of the sensor.
7	To record a customer name	Select <b>[7] - Customer Name</b> and enter the name of your company.
8	To record the system number	Select <b>[8] - System Number</b> and enter the system number or a number relevant to your company.
9	To record the MTS identification code	Select <b>[9] - MTS Id Code</b> and enter the code number or a number relevant to your company.
10	To record the sensor identification numbers	Select <b>[10] - Sensor Id Numbers</b> and enter the sensor Model number, then the sensor serial number.
11	To record the sensor identification numbers.	Select <b>[11] - Conditioner Id Numbers</b> and enter the conditioner Model number, then the conditioner serial number.
12	To record a description	Select <b>[12] - Description</b> . You can type up to 254 characters of additional information for the sensor data base.

## Task 3 Saving the Data Base

---

This task has two parts:

- ◆ Saving the data base you've created to this point.
  - ◆ Saving the data base periodically during the remainder of the calibration procedure.
- 

### Save the data base

The data base is associated with a sensor (sensor name) and the range you are calibrating. Saving the data base either creates a new data base or overwrites an existing data base.

Select **[3] - Save DB Record** in the Sensor Information Menu.

- ◆ The prompt warns you if another sensor/range record of the same name will be overwritten.
  - ◆ Select **Yes** to save the record.
  - ◆ Select **No** to return to the Sensor Information menu without saving the record.
- 

### Save your work periodically

We recommend you save your work periodically to avoid losing your work should something unexpected happen such as a power loss or human error. References in the reminder of the calibration procedure to "**save your work**" represents the following procedure:

- Select **[1] - Define Sensor Information** in the Sensor Calibration Main Menu.
  - Select **[3] - Save DB Record** in the Sensor Information Menu.
  - Enter "1" to update the file you are working on.
  - Exit the Sensor Information Menu.
-

## Task 4 Defining the Calibration Equipment

---

**Note** Task 4 is not required for the proper operation of the LVDT; however, it does record important information for calibration traceability purposes.

Defining the calibration equipment allows you to maintain a record of the calibration equipment used in the calibration along with the calibration data.

---

- Procedure**
1. Open the Define Equipment window 239
  2. Define the digital voltmeter 239
  3. Define the dial indicator 239
  4. Record any additional information 240
  5. Return to the main menu 240
- 

### Step 1 Open the Define Equipment window

Select **[2] - Define Equipment and Test Parameters** in the Sensor Calibration Main Menu.

---

### Step 2 Define the digital voltmeter

Select **[1] - Digital Volt Meter [DVM]** in the Equipment and Test Parameters Menu.

Enter the voltmeter calibration ID number then enter the next calibration date.

---

### Step 3 Define the dial indicator

Select **[6] - Dial Indicator** in the Equipment and Test Parameters Menu.

Enter the dial indicator calibration number then enter the next calibration date.

---

#### Step 4 Record any additional information

You may want to record information about the environment during the sensor calibration.

<b>MENU</b>	<b>PURPOSE</b>	<b>HELP</b>
10	To record the temperature	Select <b>[10] - Temperature:</b> Enter the ambient temperature during the calibration
11	To record the sensor's cable length	Select <b>[11] - Cable Length:</b> Enter the length of the sensor cable. Cables 50 feet and longer require compensation.
12	To record the hysteresis value	Select <b>[12] - Hysteresis:</b> Enter the % hysteresis, enter 0 if not known.
13	To record if the load cell is preloaded	Select <b>[13] - Load Cell Ends Preloaded:</b> Enter yes or no.
14	To record if the load cell has unequal sensitivities.	Select <b>[14] - Tension/Compression Sensitivities:</b> Enter the tension and compression sensitivities.
15	To record the calibrator's name	Select <b>[15] - Calibrator's Name:</b> Enter the name of the person responsible for the calibration of the LVDT.
16	To record a comment	Select <b>[16] - Calibrator's Comments:</b> Enter up to 254 characters of additional information for the sensor data base.

#### Step 5 Return to the main menu

Exit the Equipment and Test Parameters Menu and save your work.



## Task 5 Setting Up the Conditioner Information

---

This task establishes the initial settings for the conditioner information menu.

### Procedure

1. Open the Conditioner Information menu 241
  2. Set the initial fine gain 242
  3. Enter the excitation voltage 242
  4. Record the delta K polarity 242
  5. Set the conditioner filter 243
  6. Select the range gain 243
  7. Set the initial ac calibration factor 243
  8. Set the initial ac phase 243
- 

### Step 1 Open the Conditioner Information menu

Select **[3] - Define Conditioner Values** in the Sensor Calibration Main Menu.

The AC Conditioner information menu is displayed when you select Define Conditioner Values.

Values will be shown if you have opened or calibrated another data base.

Tasks 5 through 9 define the conditioner values.

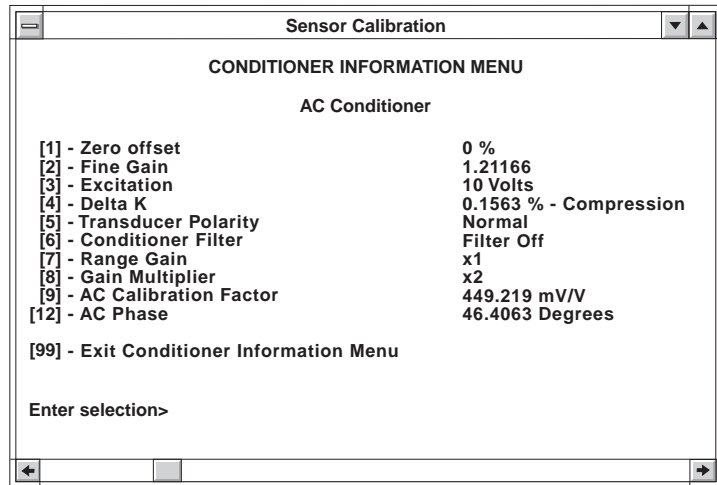

## Step 2 Set the initial fine gain

Select [2] - **Fine Gain** in the Conditioner Information Menu.

Enter a fine gain value of 1.2. This value is used as a starting point for the gain and ac calibration factor adjustments. The value is based on experience during in-house calibrations. The value is fine-tuned in Task 7, Step 4)

---

## Step 3 Enter the excitation voltage

Select [3] - **Excitation** in the Conditioner Information Menu.

All MTS LVDTs use a 10-volt excitation. Enter an excitation voltage.

**Note** *The values you enter in the conditioner menus may change when you return to the Conditioner Information Menu. This is caused by digital resolution. For example, 10.000 may change to 9.995, this is normal.*

---

## Step 4 Record the delta K polarity

The delta K polarity determines the polarity of the gain calibration (Task 7) and the polarity of the delta K adjustment (Task 8).

- ◆ If you are calibrating a sensor for the first time, set the delta K polarity to 0 (zero).
  - ◆ If you are calibrating an additional sensor range or checking calibration accuracy, note the delta K polarity.
-

## Step 5 Set the conditioner filter

Select **[6] - Conditioner Filter** in the Conditioner Information Menu.

Select **off**, filter **A** for 50 Hz filter, or filter **B** for a 500 Hz filter.

**Note** *MTS performs calibrations meeting industry standards, typically exceeding ASTM accuracy requirements. They are static calibrations traceable to NIST standards.*

*Feedback filters are sometimes used to reduce noise on the readout signal from a transducer or to gain system controllability. However, feedback filters can adversely affect accuracy under certain dynamic operating conditions. For detailed information, see MTS Technical Paper "Dynamic Accuracy Considerations #1, Feedback Signal Filtering".*

---

## Step 6 Select the range gain

Select **[7] - Range Gain** in the Conditioner Information Menu.

For the initial calibration (maximum travel) select x1. For additional ranges the range gain is determined in Task 11.

---

## Step 7 Set the initial ac calibration factor

Select **[11] - AC Calibration Factor** in the Conditioner Information Menu.

Enter the ac calibration factor value of 450. This value is used as a starting point for the gain and ac calibration factor adjustments. The value is based on experience during in-house calibrations. The value also represents the sensitivity of the sensor.

---

## Step 8 Set the initial ac phase

Select **[12] - AC Phase** in the Conditioner Information Menu.

Enter the ac phase value of 45°. This value is used as a starting point for the gain and ac phase adjustments. The value is based on experience during in-house calibrations. This value is fine-tuned in Task 7, Step 2.

---

## Task 6 Calibrating Zero

---

Calibrating zero requires the actuator to be set at mid-displacement.

During the calibration procedure you will be instructed to calibrate zero whenever you adjust the actuator through the zero reference.

---

### Procedure

1. Open the Zero offset menu 244
  2. Adjust the zero value to zero the dial indicator reading 244
- 

#### Step 1 Open the Zero offset menu

Select **[1] - Zero offset** in the Conditioner Information Menu.

---

#### Step 2 Adjust the zero value to zero the dial indicator reading

Use the arrow keys or type a value until you zero the dial indicator reading. The zero value is a reference value and has no units assigned.

Press the ESC key to return to the menu.

---

## Task 7 Calibrating Extension

---

A typical LVDT has a positive and a negative output (tension and compression). One output is calibrated with gain (typically compression) and the other output is calibrated with delta K (typically tension). Delta K compensates for differences in symmetry between the positive and negative output.

---

### Assumption

We assume the phase of your system produces a positive output for tension. If not, use the opposite polarity for any values given.

---

### Procedure

1. Exercise the actuator to remove any LVDT hysteresis 245
  2. Adjust the ac phase 246
  3. Adjust the actuator for a voltmeter reading of -8 volts 246
  4. Adjust the fine gain to achieve 80% compression 246
- 

#### Step 1 Exercise the actuator to remove any LVDT hysteresis

**Note** You can determine the polarity for the gain adjustment by checking the delta K condition on the LVDT Calibration Data sheet. If the delta K condition is positive (+), the gain polarity is negative (compression)

*If you do not know the gain polarity, adjust it for compression. Adjusting delta K will prove the gain polarity.*

Adjust the Actuator Positioning Control to cycle the actuator between zero and 100% compression of the LVDT's full-scale range three times. This exercises the LVDT to remove any hysteresis.

*For example*, when calibrating a  $\pm 3$  cm range, exercise the actuator between 0 and -3 cm. To calibrate the same LVDT for a different range such as  $\pm 1.5$  cm (the 50% range), exercise the actuator between 0 and -1.5 cm.

---

## Step 2 Adjust the ac phase

- A Adjust the Actuator Positioning Control clockwise to fully retract the actuator.
  - B Mount the dial indicator between the actuator rod and a stationary point (such as the load unit platen). Zero the dial indicator.
  - C Select **[13] AC Phase** in the Conditioner Information Menu.
  - D Adjust the phase to achieve the maximum actuator retraction. Use the arrow keys or type a value until you achieve the minimum retraction.
- 

## Step 3 Adjust the actuator for a voltmeter reading of -8 volts

Adjust the Actuator Positioning Control until the meter reads -8 volts

- ◆ If the dial indicator reading is less than 80% compression, you can adjust gain; proceed to Step 4.
- ◆ If the dial indicator reading is more than 80% compression, you can lower the excitation voltage or change the gain multiplier. In most cases you can change the excitation voltage. Changing the multiplier is a very coarse adjustment.

Select **[3] - Excitation** or **[9] - Gain Multiplier** and make an adjustment. Then repeat this step.

---

## Step 4 Adjust the fine gain to achieve 80% compression

- A Select **[2] - Fine Gain** in the Conditioner Information Menu.
  - B Adjust the fine gain value for a dial indicator reading of 80% compression. Use the arrow keys or type a value until you achieve the proper readout.
  - C Press the ESC key to return to the Conditioner Information Menu.
-

## Task 8 Calibrating Retraction

---

Task 8 has a special step called “***It didn't work***” in the event delta K cannot be calibrated.

### Procedure

1. Adjust the actuator to the zero reference 247
  2. Adjust the actuator for a meter reading of +8 volts 247
  3. Adjust delta K to achieve 80% full-scale tension 248
  4. Return to the main menu. 250
- 

#### Step 1 Adjust the actuator to the zero reference

This step adjusts the actuator so you can calibrate zero.

Adjust the Actuator Positioning Control to cycle the actuator between zero and 100% tension three times. This exercises the LVDT to remove any hysteresis.

*For example*, when calibrating a  $\pm 3$  cm range, exercise an LVDT between 0 and +3 cm. To calibrate the same LVDT for a different range such as  $\pm 1.5$  cm (the 50% range), exercise the actuator between 0 and +1.5 cm.

---

#### Step 2 Adjust the actuator for a meter reading of +8 volts

---

### Step 3 Adjust delta K to achieve 80% full-scale tension

- A Select [4] - **Delta K** in the Conditioner Information Menu.
  - B Adjust the delta K value for a dial indicator reading of 80% tension. Use the arrow keys or type a value until you achieve the meter readout.
    - ♦ If you cannot achieve 80% tension, enter a delta K value of 0 and press ESC. Proceed to the special step called **It didn't work**.
  - C Press the ESC key to return to the menu.
- 

### Step 4 Return to the main menu

Exit the Conditioner Information Menu and save your work.

---

### It didn't work

You've just discovered that your LVDT requires positive gain and negative delta K. Since the actuator is positioned for positive gain (tension) proceed as follows:

- A Select [2] - **Fine Gain** in the Conditioner Information Menu.
  - B Adjust the fine gain value for a dial indicator reading of 80% tension. Use the arrow keys or type a value until you achieve the proper readout.
  - C Return to Step 1 and calibrate delta K for compression and a negative meter reading.
-



## Task 9 Recording Data Points

---

Task 9 requires you to manually record the data points, then enter them into the sensor data base.

**Note** You have the option to record data points in 10% increments (refer to Step 3). The default is 20% increments.

---

- Procedure**
1. Record the compression data points 249
  2. Record the tension data points 250
  3. Enter the data points into the data base. 250
  4. Return to the main menu. 250
- 

### Step 1 Record the compression data points

- A Adjust the actuator to achieve the dial indicator zero reference.
  - B Adjust the actuator between zero and 100% compression three times. This exercises the LVDT to remove any hysteresis.
  - C Adjust the actuator for a dial indicator reading for 20% compression and record the meter reading. Repeat this for 40%, 60%, 80%, and 100% compression.
-

## Step 2 Record the tension data points

- A Adjust the actuator to achieve the dial indicator zero reference.
  - B Adjust the actuator between zero and 100% tension three times. This exercises the LVDT to remove any hysteresis.
  - C Adjust the actuator for a dial indicator reading for 20% tension and record the meter reading. Repeat this for 40%, 60%, 80%, and 100% tension.
- 

## Step 3 Enter the data points into the data base.

Select **[4] - Input Calibration Data Points** in the Sensor Calibration Main Menu. Review the table and select the way you want to enter your data points.

MENU	PURPOSE	HELP
1	To change the increment values and enter tension and compression data points separately.	Select <b>[1] Change Data Type and Increment Values</b> . Select the 10% or 20% increment value you want to use. Then select how you want to enter your data points: tension only, compression only, or both.
2	To change existing tension data points.	Select <b>[2] Change Tension Data Points</b> . Edit the data points with new values.
3	To change existing compression data points.	Select <b>[3] Change Compression Data Points</b> . Edit the data points with new values.
4	To enter all 10 data points using 20% increment values.	Select <b>[4] Enter All Data Points</b> . Enter the appropriate data point when prompted.

---

## Step 4 Return to the main menu.

Exit the Calibration Data Points Menu and save your work.

---

## Task 10 Calibrating Additional Ranges

---

This task allows you to calibrate additional ranges for the same sensor.

---

### Procedure

1. Determine a new range 253
  2. Go back to Task 2 253
  3. Complete the calibration and save your work 253
- 

### Using calibration templates

It is useful to calibrate additional ranges following the initial sensor calibration. The dial indicator is still mounted to the actuator and the maximum range values will be similar to additional ranges.

- ◆ All of the entry fields are blank when you first start the program and create a new data base record.
  - ◆ All the entry fields are filled with the previous data base entries when creating a new data base record after another data base has been opened or created. This allows you to modify the data fields unique to the sensor (without having to enter common data).
- 

### Procedural changes

Throughout the calibration procedure, you will find conditional steps that depend on the type of calibration you are doing (the initial calibration, additional range, calibration check). These steps serve as reminders that calibrating additional ranges require different selections. The main procedural changes are:

- ◆ Selecting the range gain (Task 5, Step 7)
  - ◆ Exercising the actuator travel range (Task 7 and Task 8, Step 1)
-

## Selecting a range gain multiplier

You establish a sensor range with the range gain selection and the fine gain adjustment in the Conditioner Information Menu.

*For example*, for an actuator with a full-scale capacity (travel) of  $\pm 4$  cm. The following are traditional ranges:

TRAVEL	RANGE	RANGE GAIN
$\pm 4$ cm	100%	x1
$\pm 2$ cm	50%	x2
$\pm 0.8$ cm	20%	x4
$\pm 0.4$ cm	10%	x8
$\pm 0.2$ cm	5%	x16

You can create your own selection of ranges. Consider the following sets of ranges.

TRAVEL RANGE	GAIN	TRAVEL RANGE	GAIN
$\pm 4$ cm	x1	$\pm 4$ cm	x1
$\pm 2$ cm	x2	$\pm 3$ cm	x1 or x2
$\pm 1$ cm	x4	$\pm 2$ cm	x2
$\pm 0.5$ cm	x8	$\pm 1$ cm	x4

*For example*, calibrating a  $\pm 3$  cm range falls between two ranges. Calibrating this range may use a range gain of x1 or x2 (with a lot of gain adjustment).

---

## Step 1 Determine a new range

The first range you calibrate is usually the maximum travel of the sensor (full-scale capacity or 100% range). Additional ranges allow you to perform tests with greater resolution for ranges less than the sensor's maximum travel.

Determine the range you wish to calibrate and note the appropriate range gain multiplier. Each range overlaps the neighboring ranges. Select ranges according to a convenient travel range.

For example, using an actuator with a travel range of  $\pm 4$  cm produces the following ranges:

---

<b>RANGE GAIN</b>	<b>RANGE</b>	<b>TRAVEL RANGE</b>
<b>x1</b>	100%	$\pm 4$ cm
<b>x2</b>	50%	$\pm 2$ cm
<b>x4</b>	25%	$\pm 1$ cm
<b>x8</b>	12.5%	$\pm 0.5$ cm
<b>x16</b>	6.25%	$\pm 0.25$ cm

---

## Step 2 Go back to Task 2

When you have determined what range to calibrate next, return to Task 2 and complete the calibration procedure for the new range.

---

## Step 3 Complete the calibration and save your work

After you have calibrated all the needed ranges, perform the following:

- A Disconnect the digital voltmeter from the rear panel.
  - B Remove the dial indicator from the actuator.
  - C If you did not save the calibration in Task 10, Step 4, save the calibration now (refer to Task 3).
  - D Enter 99 to exit the calibration program.
  - E Close TestStar. The TestStar interlocks will not work after using the Sensor Calibration program.
-





# *TestStar™ II*

Control System

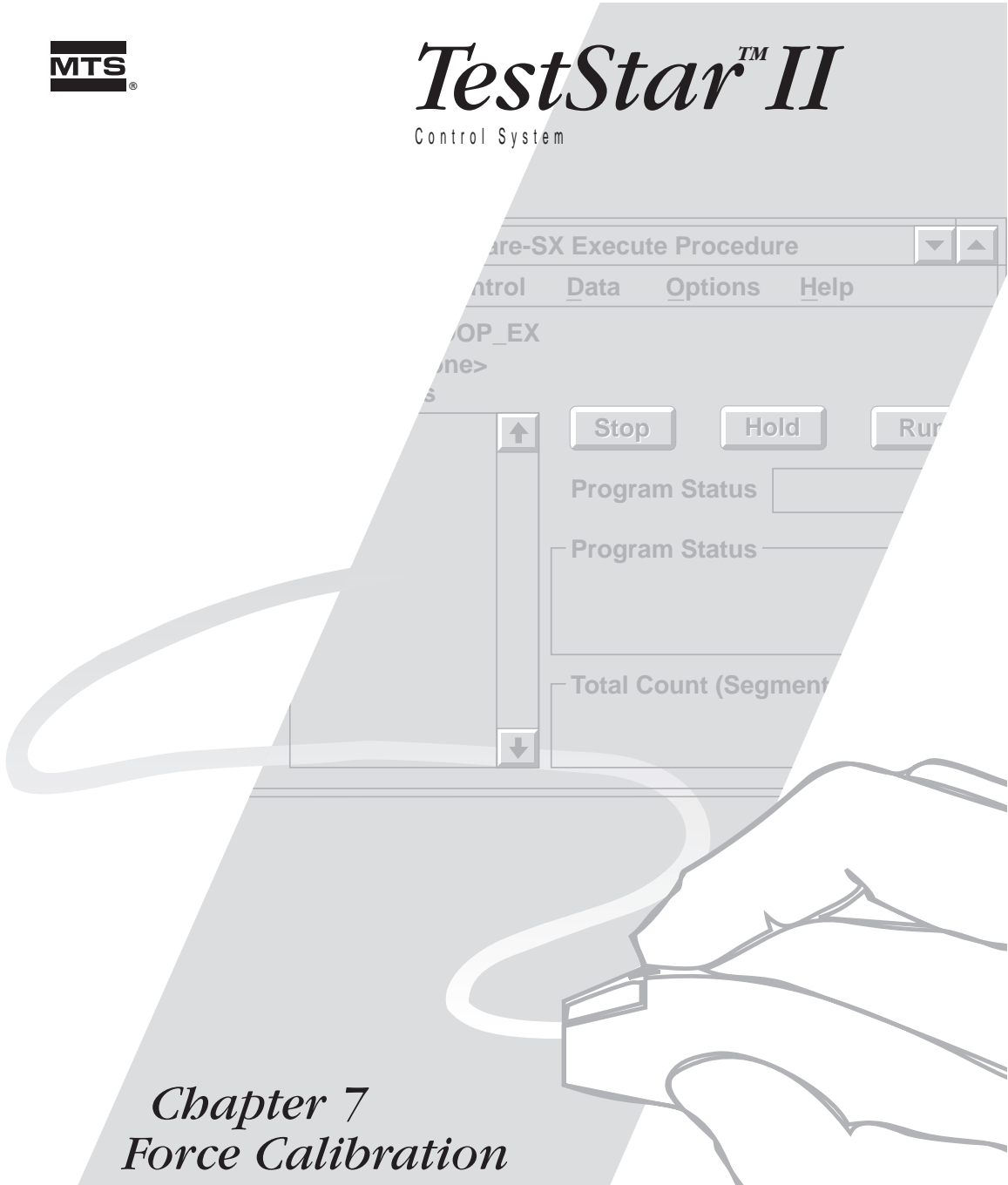

## *Chapter 7 Force Calibration*

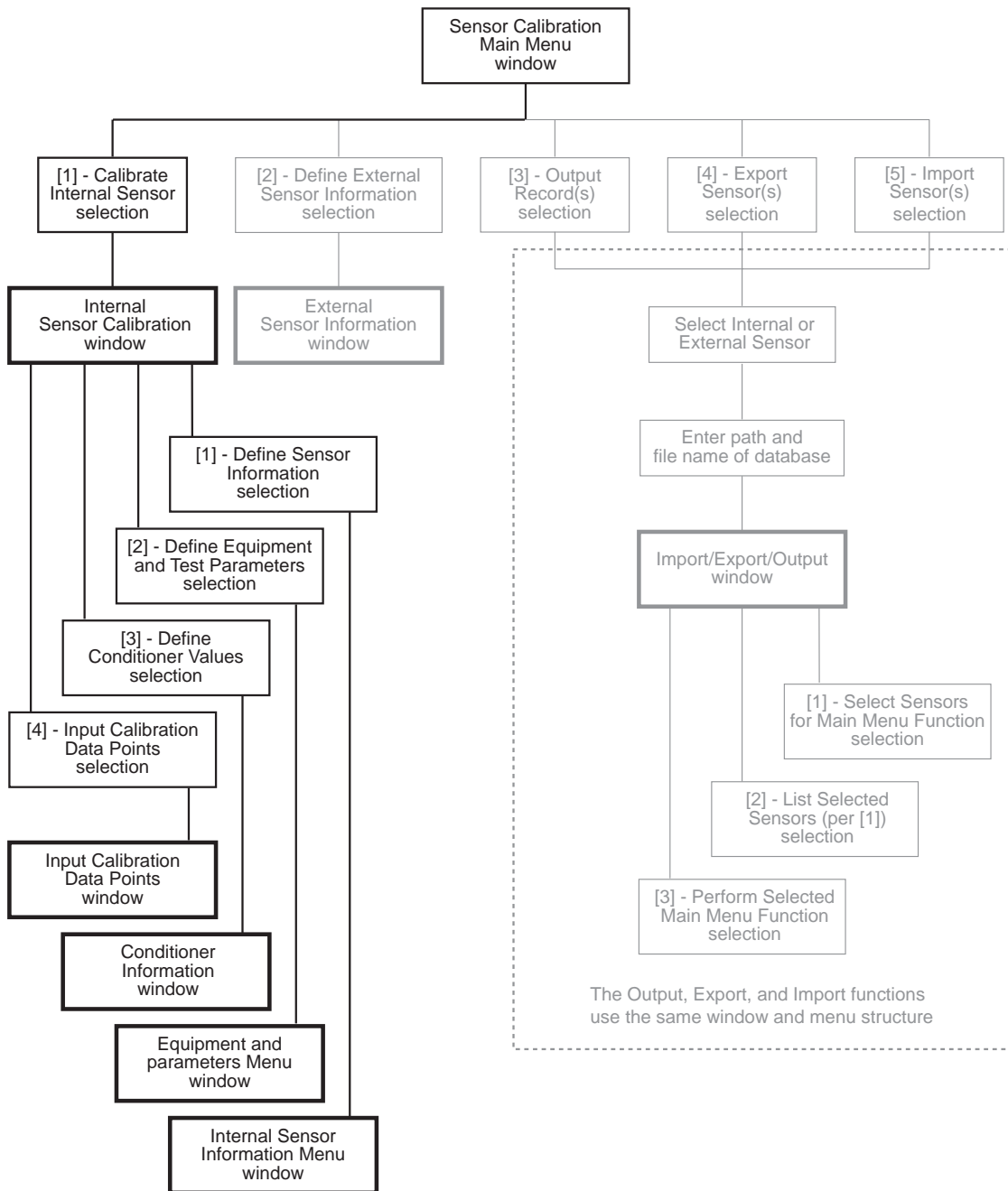



## Chapter 7

# Force Calibration

---

This chapter describes how to calibrate a force sensor for use with TestStar. Use this procedure as a guideline for other sensors that require a DC conditioner.

### Important

**When you finish using the Sensor Calibration program, be sure to shutdown TestStar, then restart it.**

The Sensor Calibration program disables all the TestStar interlocks. TestStar must be restarted to re-establish the interlock systems.

### Contents

[General Information 257](#)

[Abbreviated Procedure 259](#)

[Detailed Procedure 261](#)

---

### What you will need

You will need the following items to calibrate a force sensor:

- ◆ The force sensor documentation
  - ◆ A load standard
  - ◆ A digital voltmeter (DVM)
- 

### Assumptions

When you start the force sensor calibration, we assume the following are true:

- ◆ The force sensor is properly installed on the load unit.
  - ◆ Electrical power is applied to the digital controller for at least 30 minutes before you start the procedure.
  - ◆ You have logged onto the TestStar application.
  - ◆ You have defined a force input signal and control mode using the pod command source with the force signal.
-

## Sensor calibration program

The force calibration procedure creates a calibration data base for each range of a new sensor. Use the Sensor Calibration program to recalibrate a force sensor periodically.

---

## What are calibration data base records?

A calibration data base record is a file that contains information about a calibrated sensor. Each data base record is the calibration information for a single range of a sensor. The data base that is created includes the following:

- ◆ Sensor information (model, type, serial number, calibration date)
  - ◆ Equipment information (identifies the equipment used in the calibration)
  - ◆ Conditioner information (serial number, model number, excitation voltage, circuit parameters)
  - ◆ Calibration data points
- 

## Abbreviated procedure

The abbreviated procedure provides a concise sequence of the calibration procedure for those who are experienced at calibrating sensors with TestStar.

The abbreviated procedure lists the tasks and steps of the calibration procedure. Each step includes the page number of the detailed procedure where the step is fully explained.

---

## Detailed procedure

The detailed procedure provides an enhanced sequence of the calibration procedure for those who are inexperienced at calibrating sensors with TestStar.

The detailed procedure is a step-by-step procedure arranged by tasks. Each Task is a general group of steps. Each step includes detailed information as to how to complete the step. Some steps include examples or helpful information.

---

## Abbreviated Procedure

---

- Task 1 Locate relevant documentation 261
  - 1. Locate relevant documentation 261
  - 2. Install the sensor cartridge into the dc conditioner 262
  - 3. Open a TestStar configuration file 262
  - 4. Set up to monitor the force signal 263
  - 5. Select a force control mode for the LUC 264
  - 6. Turn on hydraulic power 265
  - 8. Start the Sensor Calibration program 266
  - 9. Open the internal sensor calibration screen 266
- Task 2 Creating a New Sensor Data Base 267
  - 1. Open the Define Sensor Information screen 267
  - 2. Create or open a data base record 268
  - 3. Enter any optional information for the data base 269
- Task 3 Saving the Data Base 270
- Task 4 Defining the Calibration Equipment 271
  - 1. Open the Define Equipment window 271
  - 2. Define the digital voltmeter 271
  - 3. Define the force sensor calibrator 271
  - 4. Record any additional information 272
  - 5. Return to the main menu 272
- Task 5 Setting Up the Conditioner Information 273
  - 1. Open the Conditioner Information menu 273
  - 2. Enter the excitation voltage 274
  - 3. Record the Delta K polarity 274
  - 4. Turn the conditioner filter off 274
  - 5. Select the range gain 274

- Task 6 Calibrating Zero 275
1. Open the Zero offset menu 275
  2. Adjust the APC to zero the voltmeter reading 275
  3. Adjust the zero value to zero the load standard readout 275
- Task 7 Calibrating Compression 276
1. Exercise the force sensor to remove hysteresis 276
  2. Adjust the APC for a voltmeter reading of -8 volts 277
  3. Adjust the fine gain for a readout of 80% compression 277
- Task 8 Calibrating Tension 278
1. Adjust the APC for a meter reading of zero 278
  2. Adjust the APC for a voltmeter reading of +8 volts 278
  3. Adjust delta K for a readout of 80% tension 279
  4. Record any additional information 272
- It didn't work 279
- Task 9 Establishing Shunt Calibration 280
1. Zero the force sensor's output 280
  2. Change the LUC control mode 280
  3. Execute sensor cal 281
  4. Select force control mode for the LUC 281
- Task 10 Recording Data Points 282
1. Record the compression data points 282
  2. Calibrate zero and record the tension data points 282
  3. 1 Enter the data points into the data base. 283
  4. Return to the main menu. 283
- Task 11 Calibrating Additional Ranges 284
1. Determine a new range 286
  2. Go back to Task 2 286
  3. Complete the calibration 286

## Task 1 Getting Things Ready

---

This task allows you to prepare things before you need them.

---

### Procedure

1. Locate relevant documentation 261
  2. Install the sensor cartridge into the dc conditioner 262
  3. Open a TestStar configuration file 262
  4. Set up to monitor the force signal 263
  5. Select a force control mode for the LUC 264
  6. Turn on hydraulic power 265
  7. Mount the load standard to the force sensor 265
  8. Start the Sensor Calibration program 266
  9. Open the internal sensor calibration screen 266
- 

### Step 1 Locate relevant documentation

You need to be able to get information relevant to the calibration procedure. By finding the documentation now, you will be able to complete the calibration procedure without interruption.

- ◆ You need about the sensor such as the serial number, excitation voltage, capacity, etc. The information can be found on the Force transducer Calibration Data sheet included with a calibrated sensor, or the Final Inspection card included with all MTS sensors.
  - ◆ You need the calibration identification numbers and calibration dates for the force sensor calibrator and digital voltmeter (DVM) that will be used for this calibration procedure. The calibration information is typically on a sticker attached to the equipment.
  - ◆ You need the dc conditioner serial number.
  - ◆ You need the shunt calibration resistor values for each calibration range. The resistors are located in the sensor cartridge.
-

**Step 2 Install the sensor cartridge into the dc conditioner**

Be sure the appropriate sensor cartridge is installed into the front of the associated dc conditioner. Refer to Chapter 2 to set up a range cartridge.

---

**Step 3 Open a TestStar configuration file**

You need a TestStar configuration with the following minimum requirements:

- ◆ An input signal defined to use the force sensor.

If this is the first time the force sensor is being calibrated, the input signal sensor assignment must use the special Sensor Calibration selection.

If this is recalibration of the force sensor, the input signal sensor assignment must use the existing sensor file.

- ◆ An output channel defined as an analog bus with the force transducer signal selected (if this is not defined, see Step 3)
- ◆ A control channel and at least one control mode defined to use the force feedback with the Actuator Positioning Control (Pod).

Open a configuration file from the TestStar File menu. If you created a TestStar configuration as described in Chapter 5, use that file.

---

#### Step 4 Set up to monitor the force signal

This step describes how to set up an output signal to monitor the force signal and where to connect a meter.

- A Open the Edit Output Signals window from the Edit menu.
- B Set up the window as shown.

The Device name shown is a default name.

If you named your input signal, that name would precede Conditioner.

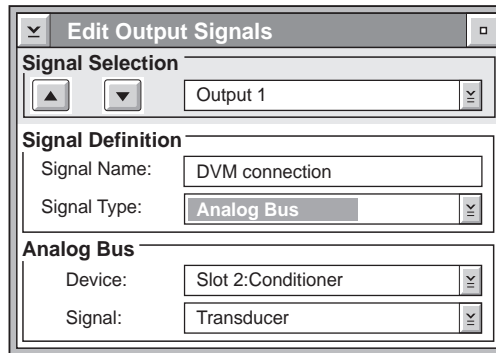

- C Connect a meter to the rear panel connector J71 if you defined Output 1 (Analog Bus A). Use J72 if you defined Output 2 (Analog Bus B). You need to know which analog bus is being used for readout later in this procedure (Task 5, Step 5).

Connect the force sensor to the rear panel connector of the associated dc conditioner.

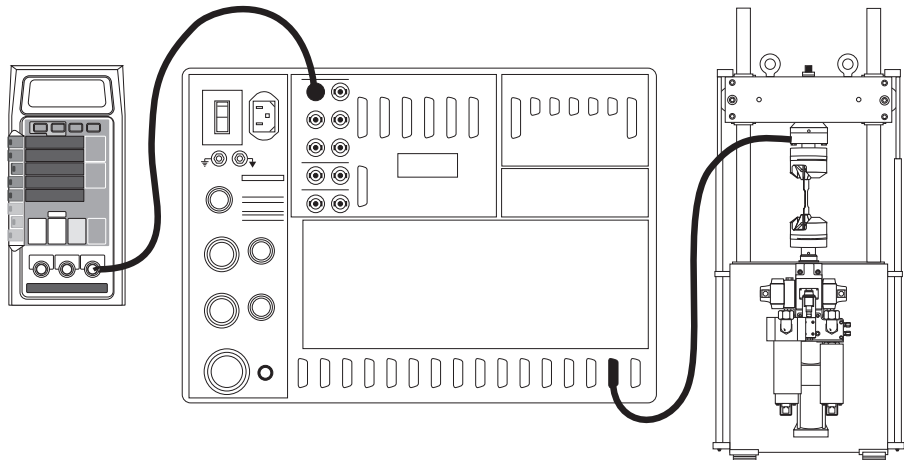

*Continued...*

**Step 4 continued**

- D Be sure the force cable is connected to a rear panel connector associated with an DC conditioner selected for the force sensor. The front panel module locations 1 through 14 correspond with the rear panel XDCR connectors J1 through J14.

*For example*, module location 2 corresponds with the rear panel connector J2 labeled XDCR 2.

**Step 5 Select a force control mode for the LUC**

A control mode for the load unit control panel is required to use the **Actuator Positioning Control**.

Select the control mode that is defined to use the force sensor as the Next APC Mode.

Press the **Actuator Positioning Control** switch on the load unit control panel to select the control mode. The name of the Next APC Mode will be displayed as the Current Mode.

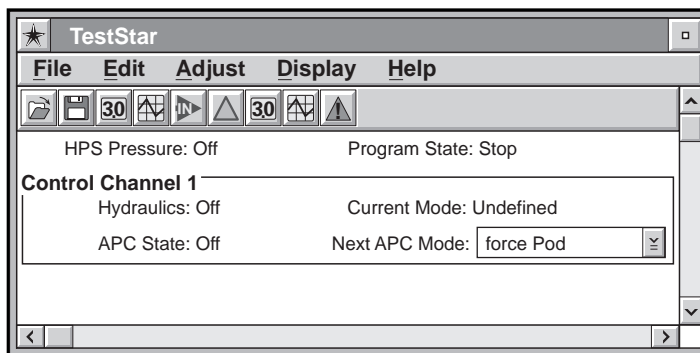
**⚠ WARNING**

**Unexpected actuator movement can occur when hydraulic pressure is turned on. This can cause personal injury or equipment damage.**

Read the Safety Precautions in the front of the Operator's Guide before you turn on the hydraulic pressure. The Safety Precautions portion describes hazards that apply to test systems and offers suggestions for avoiding hazards. It is very important that you remain aware of hazards that apply to a test system.



## Step 6 Turn on hydraulic power

The following controls are located on the load unit control panel.

- A** Press the **Interlocks Reset** switch if any interlock indicators are lit. If an indicator does not turn off, you need to correct the interlock before proceeding (refer to the reference manual).
- B** Press the **HPS Control Low** switch, then press the **High** switch to turn on the hydraulic power supply.
- C** Press the **HSM Control Low** switch, then press the **High** switch to turn on the hydraulic pressure at the service manifold (which applies hydraulic pressure to the actuator).

---

## Step 7 Mount the load standard to the force sensor

Calibrating the force sensor requires a load standard. A load standard can be a special calibrated force sensor with its own electronics or a set of calibrated dead weights.

The illustration shows a load standard in-line with the force train coupled with the force sensor.

The load standard reacts like a stiff specimen. Be sure the gain settings for the control mode are appropriate.

Be sure to connect the load standard electronics.

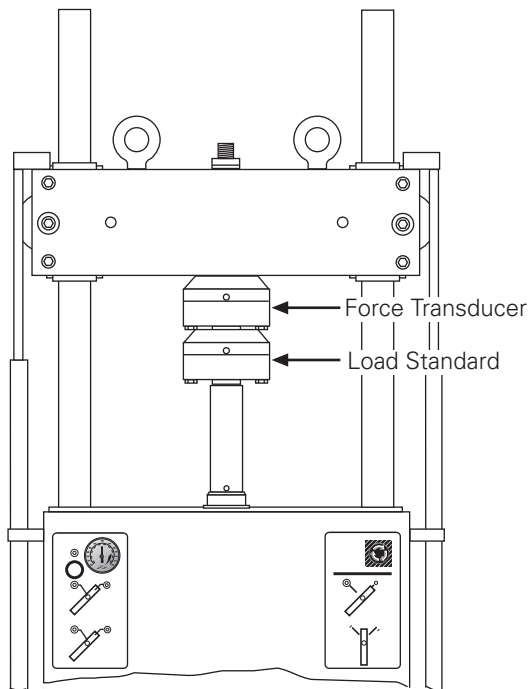

### Step 8 Start the Sensor Calibration program

Open the Sensor Calibration program in the Utilities group. Observe the WARNING when it is displayed, then press Enter.

You should see this window when you open the Sensor Calibration program.

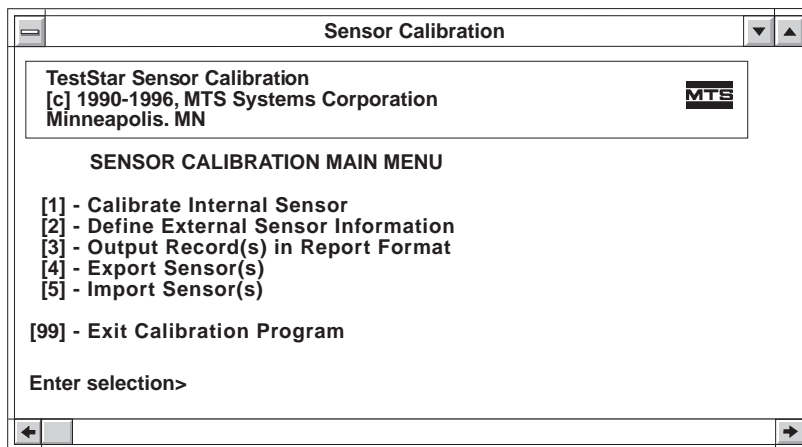

### Step 9 Open the internal sensor calibration screen

Select **[1] - Calibrate Internal Sensor** in the Sensor Calibration Main Menu.

An internal sensor is one that is connected to the rear panel of the digital controller and the sensor is conditioned with a Model 490.21 DC Conditioner.

The Internal Sensor Calibration window shows 4 functions that are used in this procedure.

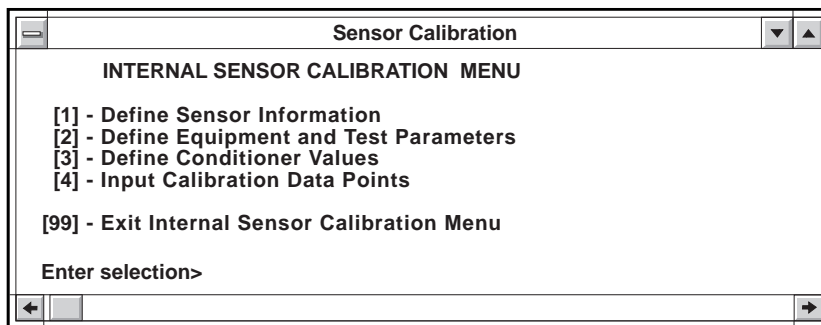

## Task 2 Creating a New Sensor Data Base

---

The information you will need to complete Task 2 can be found on the Force Transducer Calibration Data sheet that is included with sensors calibrated by MTS. Non-calibrated sensors include the appropriate information on an inspection card or equivalent data sheet.

### Procedure

**Note** *Each sensor data base uses the sensor name and range multiplier as the data base name. We recommend you use the sensor's model number for the sensor name. This provides a unique data base record and avoids overwriting an existing data base record.*

---

1. Open the Define Sensor Information screen 267
  2. Create or open a data base record 268
  3. Enter any optional information for the data base 269
- 

### Step 1 Open the Define Sensor Information screen

Select **[1] - Define Sensor Information** in the Sensor Calibration Main Menu.

---

## Step 2 Create or open a data base record

**Note** *All the entry fields are blank when you first start the program and create a new data base record. Open another data base and use it as a template. This allows you to change only the parameters unique to the sensor you are calibrating. When using a template, remember to save the data base with a different name.*

- ◆ If you are calibrating a sensor for the first time, create a new data base record (you may want to open a similar data base as a template).
- ◆ If you are checking the calibration accuracy of a sensor, open the data base record of the sensor.
- ◆ If you are calibrating a new range for a sensor, create a new data base record. When calibrating a new sensor range, use the data base of another range of the same sensor as a template. Also, the exact name of the full-scale sensor must be used.

Select **[1] - Create New DB Record** in the Sensor Information Menu. OR select **[2] - Locate Existing DB Record** in the Sensor Information Menu.

You will be prompted to provide information about the sensor you are calibrating (or the data base you are opening). The following table lists the prompts you must answer:

PROMPT	INFORMATION
Dimension	Select <b>[1] - Force</b> . This information is labeled Type on the Force Transducer Calibration Data sheet.
Name	The Model number of the sensor.
Range	The maximum travel in one direction. For force sensors with uneven travel, use the highest number.
Offset	Enter 0 if the offset is unknown.
Units	The units that define the full-scale travel.
Slot	The module location the sensor is connected.
APC	The actuator positioning control channel number.

### Step 3 Enter any optional information for the data base

The following is not required for the sensor data base. However, you may want to record important information about the sensor calibration.

MENU	PURPOSE	HELP
5	To record the next calibration date	Select <b>[5] - Next Calibration Date</b> and enter the next date the sensor should be calibrated (typically 1 year between calibrations).
6	To record the sensor's full-scale capacity	Select <b>[6] - Full Scale Capacity</b> and enter the full-scale capacity of the sensor.
7	To record a customer name	Select <b>[7] - Customer Name</b> and enter the name of your company.
8	To record the system number	Select <b>[8] - System Number</b> and enter the system number or a number relevant to your company.
9	To record the MTS identification code	Select <b>[9] - MTS Id Code</b> and enter the code number or a number relevant to your company.
10	To record the sensor identification numbers	Select <b>[10] - Sensor Id Numbers</b> and enter the sensor Model number, then the sensor serial number.
11	To record the sensor identification numbers.	Select <b>[11] - Conditioner Id Numbers</b> and enter the conditioner Model number, then the conditioner serial number.
12	To record a description	Select <b>[12] - Description</b> . You can type up to 254 characters of additional information for the sensor data base.

## Task 3 Saving the Data Base

---

This task has two parts:

- ◆ Saving the data base you've created to this point.
  - ◆ Saving the data base periodically during the remainder of the calibration procedure.
- 

### Save the data base

The data base is associated with a sensor (sensor name) and the range you are calibrating. Saving the data base either creates a new data base or overwrites an existing data base.

Select **[3]** - **Save DB Record** in the Sensor Information Menu.

- ◆ The prompt warns you if another sensor/range record of the same name will be overwritten.
  - ◆ Select **Yes** to save the record. The data base file name is established internally by using the sensor name and selected range.
  - ◆ Select **No** to return to the Sensor Information menu without saving the record.
- 

### Save your work periodically

We recommend you save your work periodically to avoid losing your work should something unexpected happen such as a power loss or human error. References in the reminder of the calibration procedure to '*save your work*' represents the following procedure:

- A** Select **[1]** - **Define Sensor Information** in the Sensor Calibration Main Menu.
  - B** Select **[3]** - **Save DB Record** in the Sensor Information Menu.
  - C** Enter "1" to update the file you are working on.
  - D** Exit the Sensor Information Menu.
-

## Task 4 Defining the Calibration Equipment

---

**Note** *Task 4 is not required for the proper operation of the force sensor; however, it does record important information for calibration traceability purposes.*

Defining the calibration equipment allows you to maintain a record of the calibration equipment used in the calibration along with the calibration data.

---

- Procedure**
1. Open the Define Equipment window 271
  2. Define the digital voltmeter 271
  3. Define the force sensor calibrator 271
  4. Record any additional information 272
  5. Return to the main menu 272
- 

### Step 1 Open the Define Equipment window

Select **[2] - Define Equipment and Test Parameters** in the Sensor Calibration Main Menu.

---

### Step 2 Define the digital voltmeter

Select **[1] - Digital Volt Meter [DVM]** in the Equipment and Test Parameters Menu.

Enter the voltmeter calibration ID number then enter the next calibration date.

---

### Step 3 Define the force sensor calibrator

Select **[5] - Force transducer Calibrator** in the Equipment and Test Parameters Menu.

Enter the load standard calibration number; then enter the next calibration date

---

#### Step 4 Record any additional information

You may want to record information about the environment during the sensor calibration.

MENU	PURPOSE	HELP
10	To record the temperature	Select <b>[10] - Temperature:</b> enter the ambient temperature during the calibration
11	To record the sensor's cable length	Select <b>[11] - Cable Length:</b> Enter the length of the sensor cable. Cables 50 feet and longer require compensation.
12	To record the hysteresis value	Select <b>[12] - Hysteresis:</b> Enter the % hysteresis, enter 0 if not known.
13	To record if the load cell is preloaded	Select <b>[13] - Load Cell Ends Preloaded:</b> Enter yes or no.
14	To record if the load cell has unequal sensitivities.	Select <b>[14] - Tension/Compression Sensitivities:</b> enter the tension and compression sensitivities.
15	To record the calibrator's name	Select <b>[15] - Calibrator's Name:</b> Enter the name of the person responsible for the calibration of the force sensor.
16	To record a comment	Select <b>[16] - Calibrator's Comments:</b> Enter up to 254 characters of additional information for the sensor data base.

#### Step 5 Return to the main menu

Exit the Equipment and Test Parameters Menu and save your work.

---



## Task 5 Setting Up the Conditioner Information

This task establishes the initial settings for the conditioner information menu.

### Procedure

1. Open the Conditioner Information menu 273
2. Enter the excitation voltage 274
3. Record the Delta K polarity 274
4. Turn the conditioner filter off 274
5. Select the range gain 274

### Step 1 Open the Conditioner Information menu

Select **[3] - Define Conditioner Values** in the Sensor Calibration Main Menu.

The DC Conditioner information menu is displayed when you select Define Conditioner Values.

Values will be shown if you have opened or calibrated another data base.

Tasks 5 through 9 define the conditioner values.

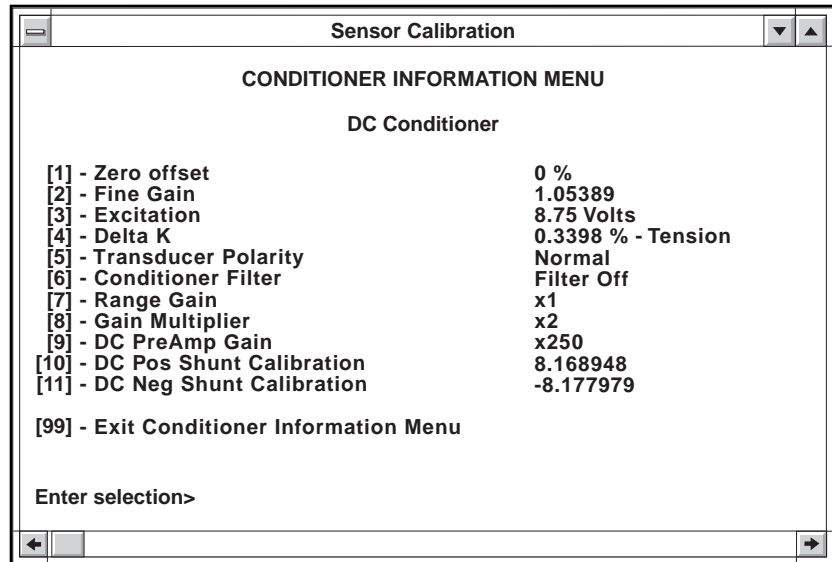

**Step 2 Enter the excitation voltage**

Select **[3] - Excitation** in the Conditioner Information Menu.

Enter the excitation voltage recorded on the Force Transducer Calibration Data sheet or Final Inspection card. The value you enter may change to the nearest digital representation.

---

**Step 3 Record the Delta K polarity**

The delta K polarity determines the polarity of the gain calibration (Task 7) and the polarity of the delta K adjustment (Task 8).

- ◆ If you are calibrating a sensor for the first time, set delta K to 0 (zero).
  - ◆ If you are calibrating an additional sensor range or checking calibration accuracy, note the delta K polarity.
- 

**Step 4 Turn the conditioner filter off**

Select **[6] - Conditioner Filter** in the Conditioner Information Menu.

Select **off**, filter **A** for 50 Hz filter, or filter **B** for a 500 Hz filter.

**Note** *MTS performs calibrations meeting industry standards, typically exceeding ASTM accuracy requirements. They are static calibrations traceable to NIST standards.*

*Feedback filters are sometimes used to reduce noise on the readout signal from a transducer or to gain system controllability. However, feedback filters can adversely affect accuracy under certain dynamic operating conditions. For detailed information, see MTS Technical Paper "Dynamic Accuracy Considerations #1, Feedback Signal Filtering".*

---

**Step 5 Select the range gain**

Select **[7] - Range Gain** in the Conditioner Information Menu.

For the initial calibration (maximum travel) select x1. For additional ranges the range gain is determined in Task 11.

---

## Task 6 Calibrating Zero

---

Calibrating zero requires the load standard to be installed on the calibrator with the force sensor.

**Note** Record the load standard readout as the zero reference. You use the load standard readout to reestablish the zero reference when you recalibrate zero later in the calibration procedure.

During the calibration procedure you will be instructed to calibrate zero whenever you adjust the calibrator through the zero reference.

---

### Procedure

1. Open the Zero offset menu 275
  2. Adjust the APC to zero the voltmeter reading 275
  3. Adjust the zero value to zero the load standard readout 275
- 

#### Step 1 Open the Zero offset menu

Select **[1] - Zero offset** in the Conditioner Information Menu.

---

#### Step 2 Adjust the APC to zero the voltmeter reading

Adjust the Actuator Positioning Control until the voltmeter readout is zero.

---

#### Step 3 Adjust the zero value to zero the load standard readout

Use the arrow keys or type a value until you zero the load standard readout. The zero value is a reference value and has no units assigned.

Press the ESC key to return to the menu.

---

## Task 7 Calibrating Compression

---

A force sensor has a positive and a negative output (tension and compression). One output is calibrated with gain (typically compression) and the other output is calibrated with delta K (typically tension). Delta K compensates for differences in symmetry between the positive and negative output.

---

### Assumption

We assume the phase of your system produces a positive output for tension. If not, reverse the polarities of the values given in Tasks 7 and 8.

---

### Procedure

1. Exercise the force sensor to remove hysteresis 276
  2. Adjust the APC for a voltmeter reading of +8 volts 278
  3. Adjust the fine gain for a readout of 80% compression 277
- 

#### Step 1 Exercise the force sensor to remove hysteresis

**Note** You can determine the polarity for the gain adjustment by checking the delta K condition on the Force Transducer Calibration Data sheet. If the delta K condition is positive (+), the gain polarity is negative (compression).

*If you do not know the gain polarity, adjust it for compression or the opposite polarity of the delta K setting noted in Task 5, Step 6. Adjusting delta K will prove the gain polarity.*

Adjust the Actuator Positioning Control for load standard readouts between zero and 100% compression three times. This exercises the force sensor to remove any hysteresis.

*For example, when calibrating a  $\pm 50$  kN range, exercise a force sensor between 0 and -50 kN. To calibrate the same force sensor for a different range such as  $\pm 25$  kN (the 50% range), exercise the force sensor between 0 and -25 kN.*

---

**Step 2 Adjust the APC for a voltmeter reading of -8 volts**

- ◆ If the load standard readout is more positive than 80% compression you can adjust gain. Proceed to Step 3.
- ◆ If the load standard readout is more negative than 80% compression, you can lower the excitation voltage or change the gain multiplier. In most cases you can change the excitation voltage. Changing the multiplier is a very coarse adjustment.

Select **[3] - Excitation** or **[9] - Gain Multiplier** and make an adjustment. Then proceed to Step 3.

---

**Step 3 Adjust the fine gain for a readout of 80% compression**

- A** Select **[2] - Fine Gain** in the Conditioner Information Menu.
  - B** Adjust the fine gain value for a load standard readout of 80% compression. Use the arrow keys or type a value until you achieve the proper readout.
  - C** Press the ESC key to return to the Conditioner Information Menu.
-

## Task 8 Calibrating Tension

---

Task 8 has a special step called “***It didn't work***” in the event delta K cannot be calibrated.

### Procedure

1. Adjust the APC for a meter reading of zero 278
  2. Adjust the APC for a voltmeter reading of +8 volts 278
  3. Adjust delta K for a readout of 80% tension 279
  4. Return to the main menu 279
- 

#### Step 1 Adjust the APC for a meter reading of zero

This step adjusts the actuator so you can calibrate zero.

Adjust the Actuator Positioning Control for voltmeter readings between zero and 100% tension three times. This exercises the force sensor to remove any hysteresis.

*For example*, when calibrating a  $\pm 50$  kN range, exercise a force sensor between 0 and +50 kN. To calibrate the same force sensor for a different range such as  $\pm 25$  kN (the 50% range), exercise the force sensor between 0 and +25 kN.

---

#### Step 2 Adjust the APC for a voltmeter reading of +8 volts

Adjust the Actuator Positioning Control on the load unit control panel for a voltmeter reading of +8 volts.

---

### Step 3 Adjust delta K for a readout of 80% tension

- A Select [**4**] - **Delta K** in the Conditioner Information Menu.
  - B Adjust the delta K value for a load standard readout of 80% tension. Use the arrow keys or type a value until you achieve the load standard readout of 80% tension.
    - ♦ If you cannot achieve +8 Vdc, enter a delta K value of 0 and press ESC. Proceed to the special step called **It didn't work**.
  - C Press the ESC key to return to the menu.
- 

### Step 4 Return to the main menu

Exit the Conditioner Information Menu and save your work.

---

### It didn't work

You've just discovered that your force sensor requires positive gain and negative delta K. Since the calibrator is set for positive gain (tension) proceed as follows:

- A Select [**2**] - **Fine Gain** in the Conditioner Information Menu.
  - B Adjust the fine gain value for a standard readout of 80% tension. Use the arrow keys or type a value until you achieve the proper readout.
  - C Return to Step 1 and calibrate delta K for compression and a negative voltmeter reading.
-

## Task 9 Establishing Shunt Calibration

---

Each range of a resistive bridge type transducer (dc sensor) uses a shunt resistor to check the calibration accuracy of the sensor/conditioner combination. Each dc conditioner supports a sensor cartridge. The sensor cartridge includes 5 shunt calibration resistors for 5 calibrated ranges. See Chapter 2 Section E to set up a sensor cartridge.

- 
- Procedure**
1. Zero the force sensor's output 280
  2. Change the LUC control mode 280
  3. Execute sensor cal 281
  4. Select force control mode for the LUC 281
- 

### Step 1 Zero the force sensor's output

Adjust the Actuator Positioning Control for a zero voltmeter reading. The sensor's output must be precisely 0.000 volts for a proper shunt calibration.

---

### Step 2 Change the LUC control mode

The shunt calibration procedure cannot be performed while the dc conditioner is being used to control the servo loop.

- A** Press the **Actuator Positioning Control** switch on the load unit control panel to disable the control.
  - B** Select a control mode that is not defined to use the force sensor (such as LVDT sensor) as the Next APC Mode.
  - C** Press the **Actuator Positioning Control** switch on the load unit control panel to select the control mode. The name of the Next APC Mode will be displayed as the Current Mode.
-



### Step 3 Execute sensor cal

- A Select **[3] - Define Conditioner Values** in the Sensor Calibration Main Menu.
- B Select **[11] - Shunt Cal** in the Conditioner Information Menu.
- C Enter the value (in ohms) of the resistor associated with the range being calibrated.

Each shunt cal resistor in the sensor cartridge is associated with a range.

See [Standard shunt cal values](#) on page 77 for additional information.

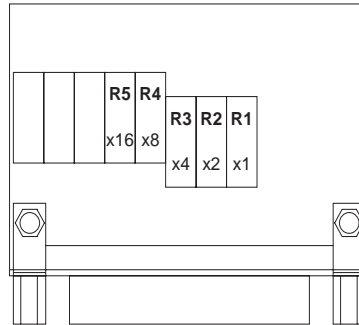

- ◆ The shunt calibration resistor value can be found on the Force Transducer Calibration or open the sensor cartridge and record the resistor value.
- ◆ The shunt cal values for the positive and negative are shown along with the shunt cal reference.
- ◆ The shunt cal values should be approximately 80% of the range. Shunt calibration values within 65% and 95% are acceptable.

### Step 4 Select force control mode for the LUC

Reestablish the force control mode for the load unit control panel.

- A Press the **Actuator Positioning Control** switch to turn the indicator off.
- B Use the F2 and F3 switches to select a force control mode.
- C Press the **Actuator Positioning Control** switch to enable the positioning control (indicator on).

## Task 10 Recording Data Points

---

This task requires you to manually record the data points, then enter them into the sensor data base.

**Note** You have the option to record data points in 10% increments (refer to Step 3). The default is 20% increments.

---

### Procedure

1. Record the compression data points 282
  2. Calibrate zero and record the tension data points 282
  3. 1 Enter the data points into the data base. 283
  4. Return to the main menu. 283
- 

#### Step 1 Record the compression data points

- A Adjust the load standard for a zero readout and calibrate zero (Task 6).
  - B Adjust the **Actuator Positioning Control** for load standard readouts between zero and 100% compression three times. This exercises the force sensor to remove any hysteresis.
  - C Adjust the **Actuator Positioning Control** for load standard readout of 100% compression and record the meter reading. Repeat this for 80%, 60%, 40%, and 20% compression.
- 

#### Step 2 Calibrate zero and record the tension data points

- A Adjust the calibrator to the zero reference and calibrate zero (Task 6).
  - B Adjust the **Actuator Positioning Control** for load standard readouts between zero and 100% tension three times. This exercises the force sensor to remove any hysteresis.
  - C Adjust the **Actuator Positioning Control** for load standard readout of 100% tension and record the meter reading. Repeat this for 80%, 60%, 40%, and 20% tension.
-

**Step 3 1Enter the data points into the data base.**

Select **[4] - Input Calibration Data Points** in the Sensor Calibration Main Menu. Review the table and select the way you want to enter your data points.

<b>MENU</b>	<b>PURPOSE</b>	<b>HELP</b>
1	To change the increment values and enter tension and compression data points separately.	Select <b>[1] Change Data Type and Increment Values.</b> Select the 10% or 20% increment value you want to use. Then select how you want to enter your data points: tension only, compression only, or both.
2	To change existing tension data points.	Select <b>[2] Change Tension Data Points.</b> Edit the data points with new values.
3	To change existing compression data points.	Select <b>[3] Change Compression Data Points.</b> Edit the data points with new values.
4	To enter all 10 data points using 20% increment values.	Select <b>[4] Enter All Data Points.</b> Enter the appropriate data point when prompted.

**Step 4 Return to the main menu.**

Exit the Calibration Data Points Menu and save your work.

---

## Task 11 Calibrating Additional Ranges

---

This task allows you to calibrate additional ranges for the same sensor.

---

### Procedure

1. [Determine a new range](#) 286
  2. [Go back to Task 2](#) 286
  3. [Complete the calibration](#) 286
- 

### Using calibration templates

It is useful to calibrate additional ranges following the initial sensor calibration. The sensor is still mounted to the calibrator and the maximum range values will be similar to additional ranges.

It is also useful to open the data base of a similar sensor to preload calibration data. In this way you only need to change specific parameters.

- ◆ All of the entry fields are blank when you first start the program and create a new data base record.
  - ◆ All the entry fields are filled with the previous data base entries when creating a new data base record after another data base has been opened or created. This allows you to modify the data fields unique to the sensor (without having to enter common data).
- 

### Procedural changes

Throughout the calibration procedure, you will find conditional steps that depend on the type of calibration you are doing (the initial calibration, additional range, calibration check). These steps serve as reminders that calibrating additional ranges require different selections. The main procedural changes are:

- ◆ Selecting the range gain (Task 5, Step 5)
  - ◆ Exercising the force sensor travel range (Task 7 and Task 8, Step 1)
  - ◆ Selecting the appropriate shunt calibration resistor (Task 9)
-

## Selecting a range gain multiplier

You establish a sensor range with the range gain selection and the fine gain adjustment in the Conditioner Information Menu.

*For example*, for a force sensor with a full-scale capacity of  $\pm 50$  kN. The following are traditional ranges

CAPACITY	RANGE	RANGE GAIN
$\pm 50$ kN	100%	x1
$\pm 25$ kN	50%	x2
$\pm 10$ kN	20%	x4
$\pm 5$ kN	10%	x8
$\pm 2.5$ kN	5%	x16

You can create your own selection of ranges. Consider the following sets of ranges.

CAPACITY RANGE	GAIN
$\pm 50$ kN	x1
$\pm 30$ kN	x2
$\pm 15$ kN	x4
$\pm 5$ kN	x8
$\pm 2.5$ kN	x16

CAPACITY RANGE	GAIN
$\pm 50$ kN	x1
$\pm 40$ kN	x1 or x2
$\pm 30$ kN	x2
$\pm 20$ kN	x4
$\pm 10$ kN	x8

*For example*, calibrating a  $\pm 40$  kN range falls between two ranges. Calibrating this range may use a range gain of x1 or x2 (with a lot of gain adjustment).

**Step 1 Determine a new range**

The first range you calibrate is usually the maximum force of the sensor (full-scale capacity or 100% range). Additional ranges allow you to perform tests with greater resolution for ranges less than the sensor's maximum force.

Determine the range you wish to calibrate and note the appropriate range gain multiplier. Each range overlaps the neighboring ranges. Select ranges according to a convenient travel range.

RANGE GAIN	RANGE	TRAVEL RANGE
x1	100%	±50 kN
x2	50%	±25 kN
x4	25%	±12.5 kN
x8	12.5%	±6.25 kN
x16	6.25%	±0.25 kN

*For example*, using a force sensor with a travel range of ±50 kN, you may use the x4 range gain for a ±10 kN travel range.

**Step 2 Go back to Task 2**

When you have determined what range to calibrate next, return to Task 2 and complete the calibration procedure for the new range.

**Step 3 Complete the calibration**

After you have calibrated all of the needed ranges, perform the following:

- A** Disconnect the digital voltmeter from the rear panel.
- B** Remove the force sensor from the calibrator.
- C** If you did not save the calibration in Task 10, Step 4, save the calibration now (refer to Task 3).
- D** Enter 99 to exit the calibration program.
- E** Close TestStar. The TestStar interlocks will not work after using the Sensor Calibration program.



# TestStar™ II

Control System

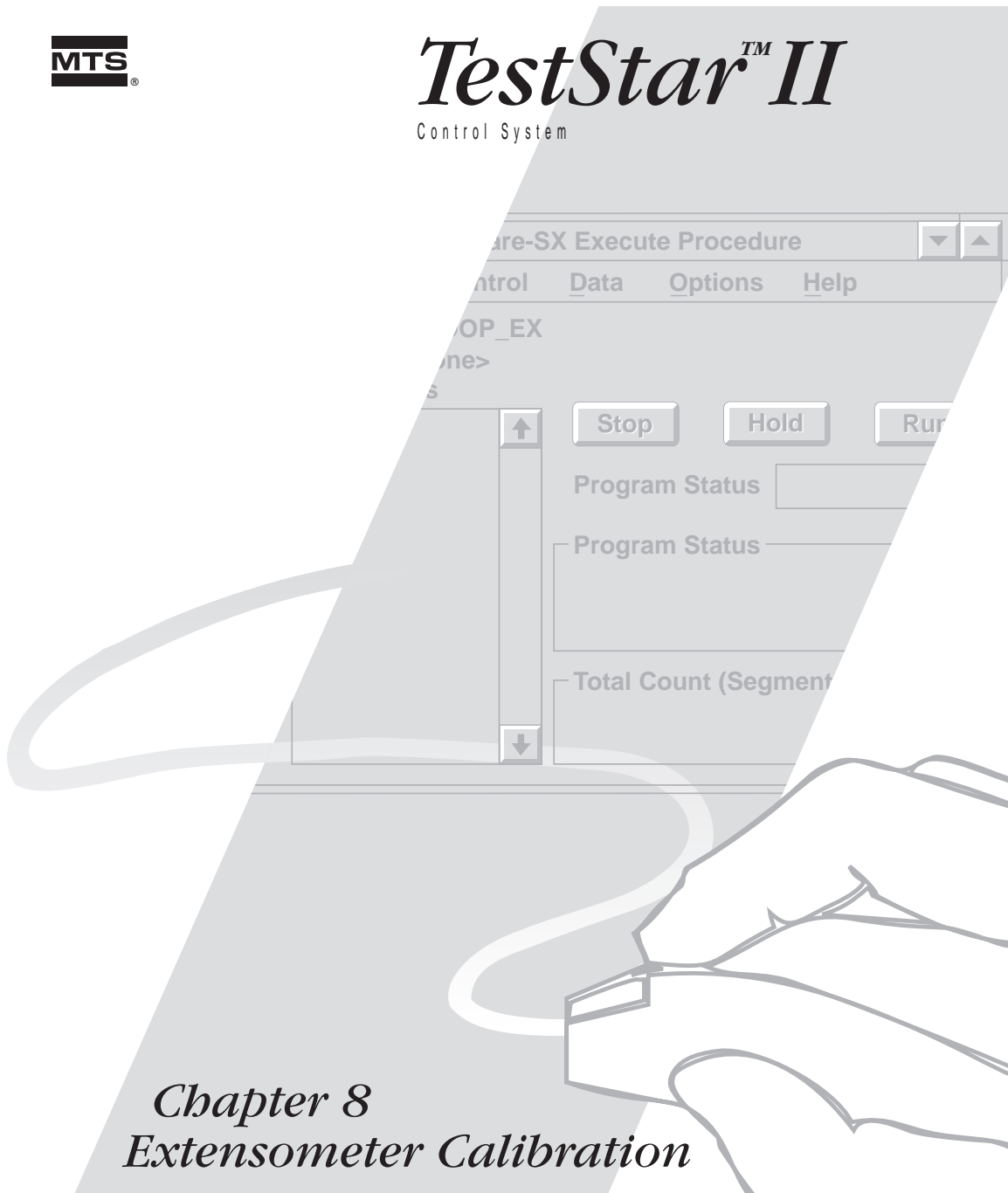

## *Chapter 8* *Extensometer Calibration*

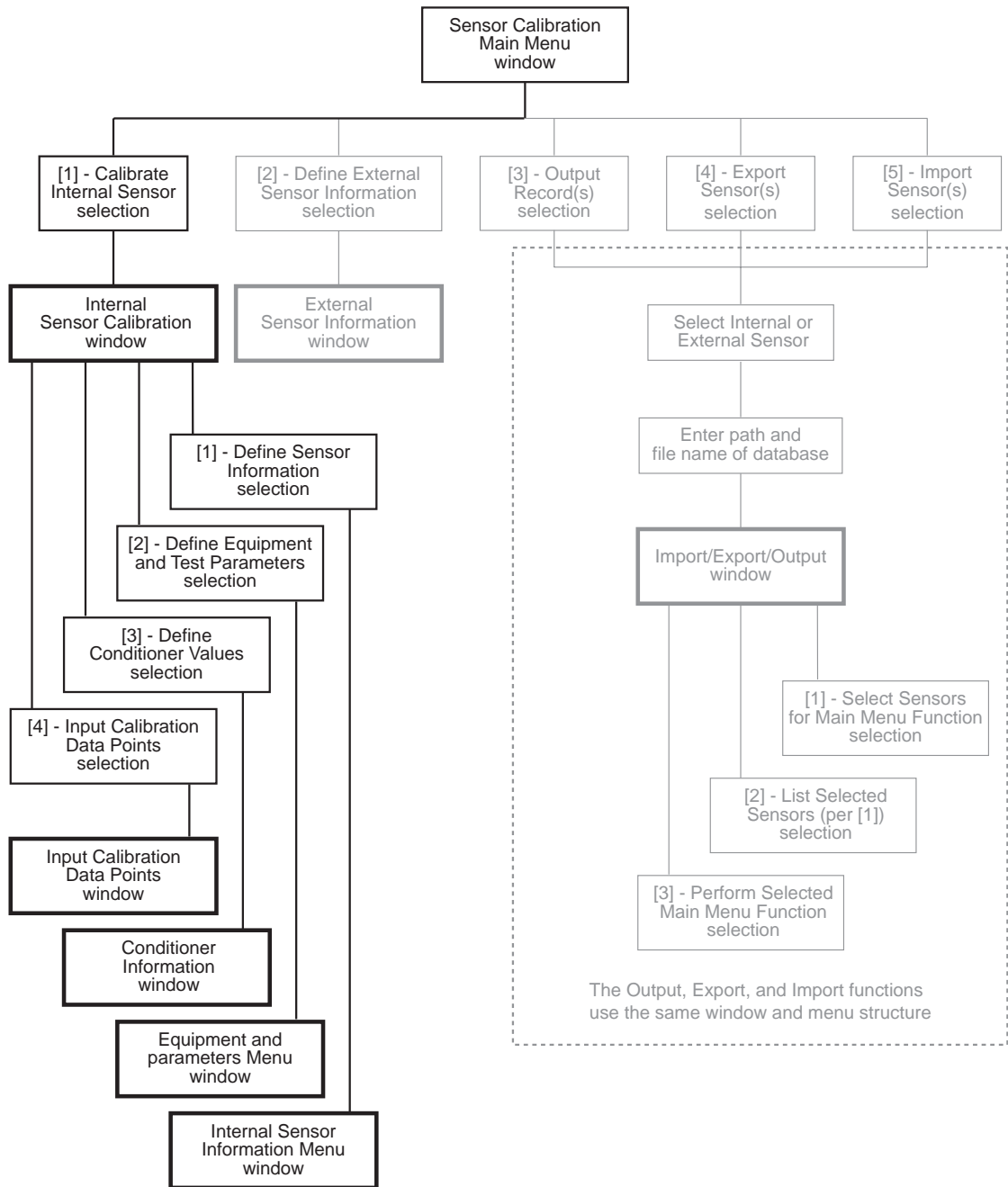



# Extensometer Calibration

---

This chapter describes how to calibrate an extensometer for use with TestStar. Use this procedure as a guideline for other sensors that require a DC conditioner.

## Important

---

**When you finish using the Sensor Calibration program, be sure to shutdown TestStar, then restart it.**

The Sensor Calibration program disables all the TestStar interlocks. TestStar must be restarted to re-establish the interlock systems.

---

## Contents

General Information 289

Abbreviated Procedure 291

Detailed Procedure 293

---

## What you will need

You will need the following items to calibrate an extensometer:

- ◆ The extensometer and its documentation
  - ◆ An extensometer calibrator
  - ◆ A digital voltmeter (DVM)
- 

## Assumptions

When you start the extensometer calibration, we assume the following are true:

- ◆ Electrical power is applied to the digital controller for at least 30 minutes before you start the procedure.
  - ◆ You have logged onto the TestStar application.
  - ◆ You have defined a strain input signal (extensometer) and control mode using the pod command source with the strain signal.
-

## Sensor calibration program

The extensometer calibration procedure creates a calibration data base for each range of a new sensor. Use the Sensor Calibration program to recalibrate an extensometer periodically.

---

## What are calibration data base records?

A calibration data base record is a file that contains information about a calibrated sensor. Each data base record is the calibration information for a single range of a sensor. The data base that is created includes the following:

- ◆ Sensor information (model, type, serial number, calibration date)
  - ◆ Equipment information (identifies the equipment used in the calibration)
  - ◆ Conditioner information (serial number, model number, excitation voltage, circuit parameters)
  - ◆ Calibration data points
- 

## Abbreviated procedure

The abbreviated procedure provides a concise sequence of the calibration procedure for those who are experienced at calibrating sensors with TestStar.

The abbreviated procedure lists the tasks and steps of the calibration procedure. Each step includes the page number of the detailed procedure where the step is fully explained.

---

## Detailed procedure

The detailed procedure provides an enhanced sequence of the calibration procedure for those who are inexperienced at calibrating sensors with TestStar.

The detailed procedure is a step-by-step procedure arranged by tasks. Each task is a general group of steps. Each step includes detailed information as to how to complete the step. Some steps include examples or helpful information.

---

# Abbreviated Procedure

---

## Task 1 Getting Things Ready 293

1. Locate relevant documentation 293
2. Open a TestStar configuration file 294
3. Set up to monitor the extensometer signal 294
4. Install the sensor cartridge into the dc conditioner 295
5. Select a strain control mode for the LUC 296
6. Mount the extensometer to the calibrator 296
7. Start the Sensor Calibration program 297
8. Open the internal sensor calibration screen 297

## Task 2 Creating a New Sensor Data Base 298

1. Open the Define Sensor Information screen 298
2. Create or open a data base record 299
3. Enter any optional information for the data base 300

## Task 3 Saving the Data Base 301

## Task 4 Defining the Calibration Equipment 302

1. Open the Define Equipment window 302
2. Define the digital voltmeter 302
3. Define the extensometer calibrator 302
4. Record any additional information 303
5. Return to the main menu 303

## Task 5 Setting Up the Conditioner Information 304

1. Open the Conditioner Information menu 304
2. Enter the excitation voltage 305
3. Record the delta K polarity 305
4. Set the conditioner filter 305
5. Select the range gain 305

**Task 6 Calibrating Zero 306**

1. Open the Zero offset menu 306
2. Adjust the zero value to zero the voltmeter reading 306
3. Remove the zero pin from the extensometer 306

**Task 7 Calibrating Compression 307**

1. Exercise the extensometer to remove hysteresis 307
2. Adjust the calibrator to 80% compression 308
3. Adjust the fine gain for a voltmeter reading of -8 volts 308

**Task 8 Calibrating Tension 309**

1. Adjust the calibrator to the zero reference 309
2. Adjust the calibrator to 80% tension 309
3. Adjust delta K for a voltmeter reading of +8 volts. 309
4. Return to the main menu 310

It didn't work 310

**Task 9 Establishing Shunt Calibration 311**

1. Zero the extensometer output 311
2. Execute sensor cal 312

**Task 10 Recording Data Points 313**

1. Record the compression data points 313
2. Calibrate zero and record the tension data points 313
3. Enter the data points into the data base. 314
4. Return to the main menu. 314

**Task 11 Calibrating Additional Ranges 315**

1. Determine a new range 317
2. Go back to Task 2 317
3. Complete the calibration 317

## Task 1 Getting Things Ready

---

This task allows you to prepare things before you need them.

### Procedure

1. Locate relevant documentation 293
  2. Open a TestStar configuration file 294
  3. Set up to monitor the extensometer signal 294
  4. Install the sensor cartridge into the dc conditioner 295
  5. Select a strain control mode for the LUC 296
  6. Mount the extensometer to the calibrator 296
  7. Start the Sensor Calibration program 297
- 

#### Step 1 Locate relevant documentation

- ◆ You need information about the sensor such as the serial number, excitation voltage, travel, etc. This information can be found on the Extensometer Calibration Data sheet included with a calibrated sensor, or the Final Inspection card included with all MTS sensors.
- ◆ You need the calibration identification numbers and calibration dates for the extensometer calibrator and digital voltmeter (DVM) that will be used for this calibration procedure. The calibration information is typically on a sticker attached to the equipment.
- ◆ You need information about the specific calibration procedure for the extensometer to determine how this generic procedure may need to be modified. This information can be found in the extensometer product manual included with the extensometer.

*For example*, the product manual may have information on how to mount the extensometer, set up the calibrator, or calibrate uneven travel.

- ◆ The dc conditioner serial number
  - ◆ The shunt calibration resistor values for each calibration range.
-

## Step 2 Open a TestStar configuration file

You need a TestStar configuration with the following minimum requirements:

- ◆ An input signal defined to use the extensometer.
 

If this is the first time the extensometer sensor is being calibrated, the input signal sensor assignment must use the special Sensor Calibration selection.
- ◆ If this is recalibration of the extensometer, the input signal sensor assignment must use the existing sensor file.
- ◆ An output channel defined as an analog bus with the extensometer transducer signal selected (if this is not defined, see Step 3)
- ◆ A control channel and at least one control mode defined to use the extensometer feedback with the Actuator Positioning Control (Pod).

Open a configuration file from the TestStar File menu. If you created a TestStar configuration as described in Chapter 5, use that file

## Step 3 Set up to monitor the extensometer signal

This step describes how to set up an output signal to monitor the extensometer signal and where to connect a meter.

- F Open the Edit Output Signals window from the Edit menu.
- G Set up the window as shown.

The Device name shown is a default name.

If you named your input signal, that name would precede Conditioner.

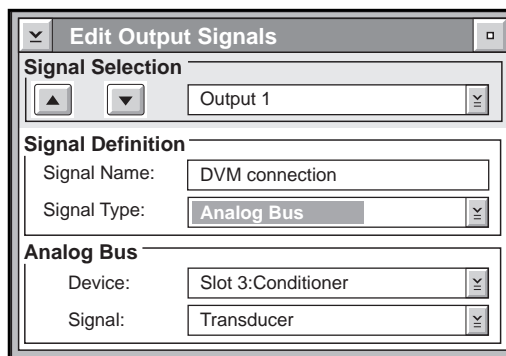

*Continued...*

- H Connect a meter to the rear panel connector J71 if you defined Output 1 (Analog Bus A). Use J72 if you defined Output 2 (Analog Bus B). You need to know which analog bus is being used for readout later in this procedure (Task).

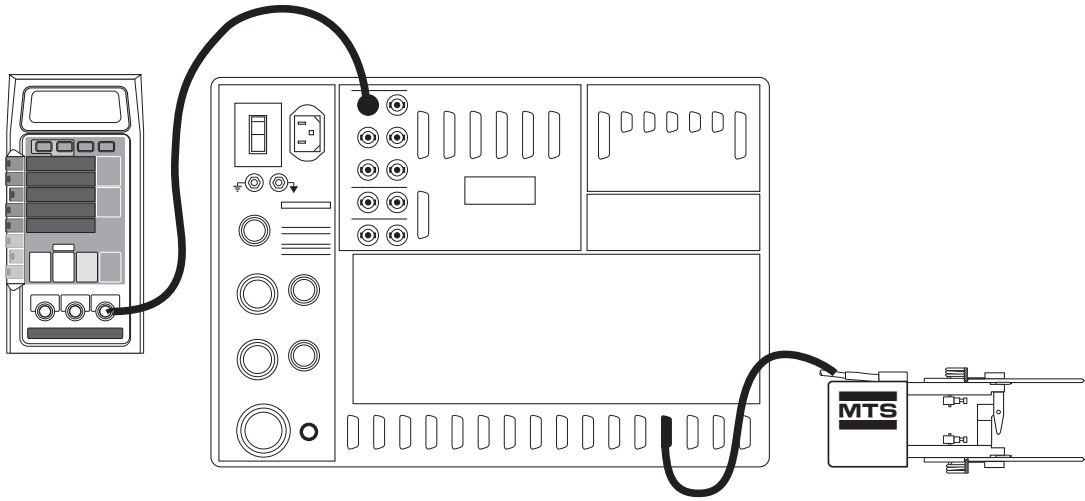

Connect the extensometer to the rear panel connector of the associated dc conditioner. Connect the voltmeter to J71.

- I Be sure the extensometer cable is connected to a rear panel connector associated with an DC conditioner selected for the force sensor. The front panel module locations 1 through 14 correspond with the rear panel XDCR connectors J1 through J14.

*For example, module location 3 corresponds with the rear panel connector J3 labeled XDCR 3.*

#### Step 4 Install the sensor cartridge into the dc conditioner

Be sure the appropriate sensor cartridge is installed into the front of the associated dc conditioner.

**Step 5 Select a strain control mode for the LUC**

A control mode for the load unit control panel is required to use the **Actuator Positioning Control**.

Select the control mode that is defined to use the strain sensor as the Next APC Mode.

Press the Actuator Positioning Control switch on the load unit control panel to select the control mode. The name of the Next APC Mode will be displayed as the Current Mode.

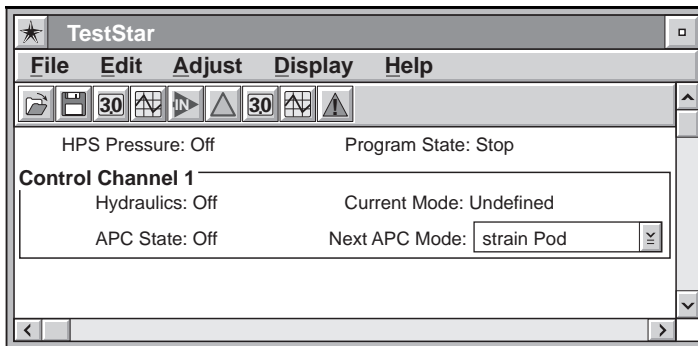

**Step 6 Mount the extensometer to the calibrator**

Review the extensometer product manual for mounting information and calibrator requirements.

The illustration shows a typical calibrator with an extensometer mounted to it.

Be sure to check the extensometer product manual for information about specific calibrators and mounting instructions.

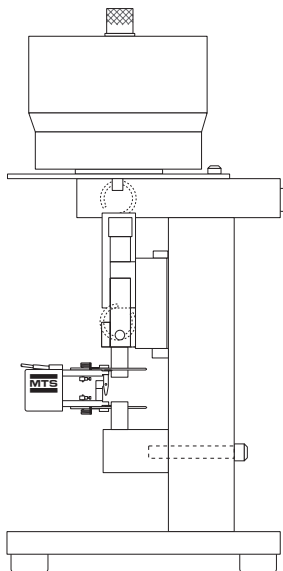



## Step 7 Start the Sensor Calibration program

Open the Sensor Calibration program in the Utilities group. Observe the WARNING when it is displayed, then press Enter.

You should see this window when you open the Sensor Calibration program.

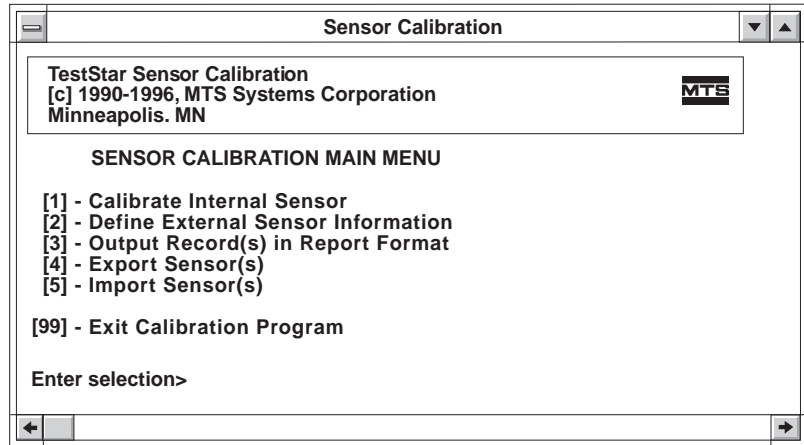

## Step 8 Open the internal sensor calibration screen

Select **[1] - Calibrate Internal Sensor** in the Sensor Calibration Main Menu.

An internal sensor is one that is connected to the rear panel of the digital controller and the sensor is conditioned with a Model 490.21 DC Conditioner.

The Internal Sensor Calibration window shows 4 functions that are used in this procedure.

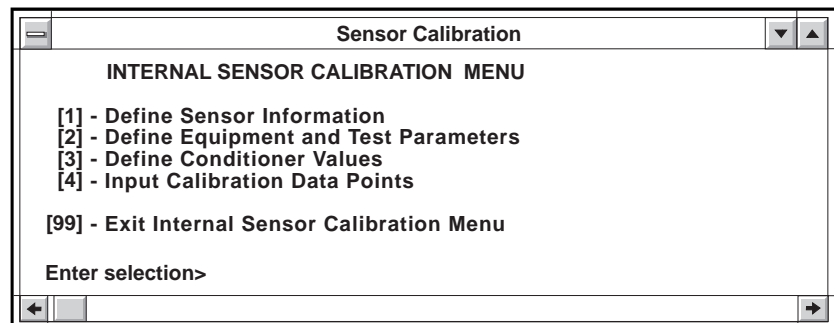

## Task 2 Creating a New Sensor Data Base

---

The information you will need to complete Task 2 can be found on the Extensometer Calibration Data sheet that is included with sensors calibrated by MTS. Non-calibrated sensors include the appropriate information on an inspection card (or equivalent data sheet).

**Note** *Each sensor data base uses the sensor name and range multiplier as the data base name. We recommend you use the sensor's model number for the sensor name. This provides a unique data base record and avoids overwriting an existing data base record.*

---

### Procedure

1. Open the Define Sensor Information screen 298
  2. Create or open a data base record 299
  3. Enter any optional information for the data base 300
- 

#### Step 1 Open the Define Sensor Information screen

Select **[1] - Define Sensor Information** in the Sensor Calibration Main Menu.

---

## Step 2 Create or open a data base record

**Note** All the entry fields are blank when you first start the program and create a new data base record. Open another data base and use it as a template. This allows you to change only the parameters unique to the sensor you are calibrating. When using a template, remember to save the data base with a different name.

- ◆ If you are calibrating a sensor for the first time, create a new data base record (you may want to open a similar data base as a template).
- ◆ If you are checking the calibration accuracy of a sensor, open the data base record of the sensor.
- ◆ If you are calibrating a new range for a sensor, create a new data base record. When calibrating a new sensor range, use the data base of another range of the same sensor as a template. Also, the exact name of the full-scale sensor must be used.

Select **[1] - Create New DB Record** in the Sensor Information Menu. OR select **[2] - Locate Existing DB Record** in the Sensor Information Menu.

You will be prompted to provide information about the sensor you are calibrating (or the data base you are opening). The following table lists the prompts you must answer:

PROMPT	INFORMATION
Dimension	Select <b>[10] - Strain</b> . This information is labeled Type on the Extensometer Calibration Data sheet.
Name	The Model number of the sensor.
Range	The maximum travel in one direction. For extensometers with uneven travel, use the highest number.
Offset	Enter 0 if the offset is unknown.
Units	The units that define the full-scale travel.
Slot	The module location the sensor is connected.
APC	The actuator positioning control channel number.

### Step 3 Enter any optional information for the data base

The following is not required for the sensor data base. However, you may want to record important information about the sensor calibration.

MENU	PURPOSE	HELP
5	To record the next calibration date	Select <b>[5] - Next Calibration Date</b> and enter the next date the sensor should be calibrated (typically 1 year between calibrations).
6	To record the sensor's full-scale capacity	Select <b>[6] - Full Scale Capacity</b> and enter the full-scale capacity of the sensor.
7	To record a customer name	Select <b>[7] - Customer Name</b> and enter the name of your company.
8	To record the system number	Select <b>[8] - System Number</b> and enter the system number or a number relevant to your company.
9	To record the MTS identification code	Select <b>[9] - MTS Id Code</b> and enter the code number or a number relevant to your company.
10	To record the sensor identification numbers	Select <b>[10] - Sensor Id Numbers</b> and enter the sensor Model number, then the sensor serial number.
11	To record the sensor identification numbers.	Select <b>[11] - Conditioner Id Numbers</b> and enter the conditioner Model number, then the conditioner serial number.
12	To record a description	Select <b>[12] - Description</b> . You can type up to 254 characters of additional information for the sensor data base.

## Task 3 Saving the Data Base

---

This task has two parts:

- ◆ Saving the data base you've created to this point.
  - ◆ Saving the data base periodically during the remainder of the calibration procedure.
- 

### Save the data base

The data base is associated with a sensor (sensor name) and the range you are calibrating. Saving the data base either creates a new data base or overwrites an existing data base.

Select **[3]** - **Save DB Record** in the Sensor Information Menu.

- ◆ The prompt warns you if another sensor/range record of the same name will be overwritten.
  - ◆ Select **Yes** to save the record.
  - ◆ Select **No** to return to the Sensor Information menu without saving the record.
- 

### Save your work periodically

We recommend you save your work periodically to avoid losing your work should something unexpected happen such as a power loss or human error. References in the reminder of the calibration procedure to “*save your work*” represents the following procedure:

- A** Select **[1]** - **Define Sensor Information** in the Sensor Calibration Main Menu.
  - B** Select **[3]** - **Save DB Record** in the Sensor Information Menu.
  - C** Enter “1” to update the file you are working on.
  - D** Exit the Sensor Information Menu.
-

## Task 4 Defining the Calibration Equipment

---

**Note** *Task 4 is not required for the proper operation of the extensometer; however, it does record important information for calibration traceability purposes.*

Defining the calibration equipment allows you to maintain a record of the calibration equipment used in the calibration along with the calibration data.

---

### Procedure

1. Open the Define Equipment window 302
  2. Define the digital voltmeter 302
  3. Define the extensometer calibrator 302
  4. Record any additional information 303
  5. Return to the main menu 303
- 

#### Step 1 Open the Define Equipment window

Select **[2] - Define Equipment and Test Parameters** in the Sensor Calibration Main Menu.

---

#### Step 2 Define the digital voltmeter

Select **[1] - Digital Volt Meter [DVM]** in the Equipment and Test Parameters Menu.

Enter the voltmeter calibration ID number, then enter the next calibration date.

---

#### Step 3 Define the extensometer calibrator

Select **[5] - Extensometer Calibrator** in the Equipment and Test Parameters Menu.

Enter the calibrator calibration number, then enter the next calibration date.

---

**Step 4 Record any additional information**

You may want to record information about the environment during the sensor calibration.

<b>MENU</b>	<b>PURPOSE</b>	<b>HELP</b>
10	To record the temperature	Select <b>[10] - Temperature:</b> Enter the ambient temperature during the calibration
11	To record the sensor's cable length	Select <b>[11] - Cable Length:</b> Enter the length of the sensor cable. Cables 50 feet and longer require compensation.
12	To record the hysteresis value	Select <b>[12] - Hysteresis:</b> Enter the % hysteresis, enter 0 if not known.
13	To record if the load cell is preloaded	Select <b>[13] - Load Cell Ends Preloaded:</b> Enter yes or no.
14	To record if the load cell has unequal sensitivities	Select <b>[14] - Tension/Compression Sensitivities:</b> Enter the tension and compression sensitivities.
15	To record the calibrator's name	Select <b>[15] - Calibrator's Name:</b> Enter the name of the person responsible for the calibration of the extensometer.
16	To record a comment	Select <b>[16] - Calibrator's Comments:</b> Enter up to 254 characters of additional information for the sensor data base.

**Step 5 Return to the main menu**

Exit the Equipment and Test Parameters Menu and save your work.

---

## Task 5 Setting Up the Conditioner Information

This task establishes the initial settings for the conditioner information menu.

### Procedure

1. Open the Conditioner Information menu 304
2. Enter the excitation voltage 305
3. Record the delta K polarity 305
4. Set the conditioner filter 305
5. Select the range gain 305

### Step 1 Open the Conditioner Information menu

Select **[3] - Define Conditioner Values** in the Sensor Calibration Main Menu.

The DC Conditioner information menu is displayed when you select Define Conditioner Values.

Values will be shown if you have opened or calibrated another data base.

Tasks 5 through 9 define the conditioner values.

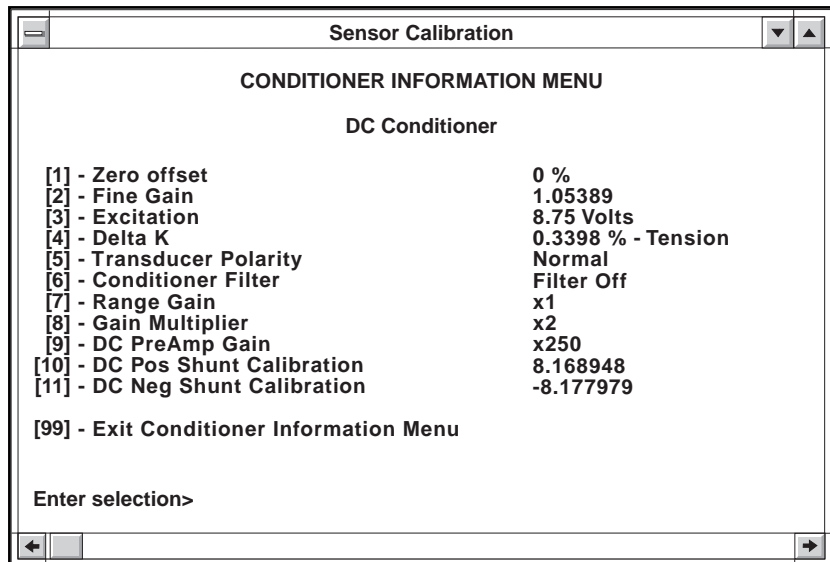



## Step 2 Enter the excitation voltage

Select **[3] - Excitation** in the Conditioner Information Menu.

Enter the excitation voltage recorded on the Extensometer Calibration Data sheet or Final Inspection card. The value you enter may change to the nearest digital representation.

---

## Step 3 Record the delta K polarity

The delta K polarity determines the polarity of the gain calibration (Task 7) and the polarity of the delta K adjustment (Task 8).

- ◆ If you are calibrating a sensor for the first time, set the delta K polarity to 0 (zero).
  - ◆ If you are calibrating an additional sensor range or checking calibration accuracy, note the delta K polarity.
- 

## Step 4 Set the conditioner filter

Select **[6] - Conditioner Filter** in the Conditioner Information Menu.

Select **off**, filter **A** for 50 Hz filter, or filter **B** for a 500 Hz filter.

**Note** *MTS performs calibrations meeting industry standards, typically exceeding ASTM accuracy requirements. They are static calibrations traceable to NIST standards.*

*Feedback filters are sometimes used to reduce noise on the readout signal from a transducer or to gain system controllability. However, feedback filters can adversely affect accuracy under certain dynamic operating conditions. For detailed information, see MTS Technical Paper "Dynamic Accuracy Considerations #1, Feedback Signal Filtering"*

---

## Step 5 Select the range gain

Select **[7] - Range Gain** in the Conditioner Information Menu.

For the initial calibration (maximum travel) select x1. For additional ranges the range gain is determined in Task 11.

---

## Task 6 Calibrating Zero

---

Calibrating zero requires the extensometer to be installed on the calibrator with the zero pin installed (if included). The zero pin ensures a zero (null) output.

**Note** Record the calibrator setting as the zero reference. Once the zero pin is removed from the extensometer, use the calibrator setting to reestablish the zero reference when you recalibrate zero later in the calibration procedure.

During the calibration procedure you will be instructed to calibrate zero whenever you adjust the calibrator through the zero reference.

---

### Procedure

1. Open the Zero offset menu 306
  2. Adjust the zero value to zero the voltmeter reading 306
  3. Remove the zero pin from the extensometer 306
- 

#### Step 1 Open the Zero offset menu

Select **[1] - Zero offset** in the Conditioner Information Menu.

---

#### Step 2 Adjust the zero value to zero the voltmeter reading

Use the arrow keys or type a value until you zero the voltmeter reading. The zero value is a reference value and has no units assigned.

Press the ESC key to return to the menu.

---

#### Step 3 Remove the zero pin from the extensometer

This only needs to be done with extensometers that include a zero pin.

---

## Task 7 Calibrating Compression

---

A typical extensometer has a positive and a negative output (tension and compression). One output is calibrated with gain (typically compression) and the other output is calibrated with delta K (typically tension). Delta K compensates for differences in symmetry between the positive and negative output.

### Assumption

We assume the phase of your system produces a positive output for tension.

### Procedure

1. Exercise the extensometer to remove hysteresis 307
2. Adjust the calibrator to 80% compression 308
3. Adjust the fine gain for a voltmeter reading of -8 volts 308

#### Step 1 Exercise the extensometer to remove hysteresis

**Note** You can determine the polarity for the gain adjustment by checking the delta K condition on the Extensometer Calibration Data sheet. If the delta K condition is positive (+), the gain polarity is negative (compression).

*If you do not know the gain polarity, adjust it for compression or the opposite polarity of the delta K setting noted in Task 5. Adjusting delta K will prove the gain polarity.*

Adjust the calibrator between zero and 100% compression of the extensometer's full-scale range three times. This exercises the extensometer to remove any hysteresis.

*For example, when calibrating a  $\pm 3$  mm range, exercise an extensometer between 0 and -3 mm. To calibrate the same extensometer for a different range such as  $\pm 1.5$  mm (the 50% range), exercise the extensometer between 0 and -1.5 mm.*

## Step 2 Adjust the calibrator to 80% compression

Adjust the calibrator for 80% of the range being calibrated and note the voltmeter reading.

- ◆ If the voltmeter reading is more positive than -8 Vdc you can adjust gain; proceed to Step 3.
- ◆ If the voltmeter reading is more negative than -8 Vdc, you can lower the excitation voltage or change the gain multiplier. In most cases you can change the excitation voltage. Changing the multiplier is a very coarse adjustment.

Select **[3] - Excitation** or **[9] - Gain Multiplier** and make an adjustment. Then proceed to Step 3.

---

## Step 3 Adjust the fine gain for a voltmeter reading of -8 volts

- A** Select **[2] - Fine Gain** in the Conditioner Information Menu.
  - B** Adjust the fine gain value for a voltmeter reading of -8.000 Vdc. Use the arrow keys or type a value until you achieve the proper readout.
  - C** Press the ESC key to return to the Conditioner Information Menu.
-

## Task 8 Calibrating Tension

---

Task 8 has a special step called “***It didn’t work***” in the event delta K cannot be calibrated.

### Procedure

1. Adjust the calibrator to the zero reference 309
  2. Adjust the calibrator to 80% tension 309
  3. Adjust delta K for a voltmeter reading of +8 volts. 309
  4. Return to the main menu 310
- 

#### Step 1 Adjust the calibrator to the zero reference

Adjust the calibrator between zero and 100% tension of the extensometer’s full-scale range three times. This exercises the extensometer to remove any hysteresis.

*For example*, when calibrating a  $\pm 3$  mm range, exercise an extensometer between 0 and +3 mm. To calibrate the same extensometer for a different range such as  $\pm 1.5$  mm (the 50% range), exercise the extensometer between 0 and +1.5 mm.

---

#### Step 2 Adjust the calibrator to 80% tension

Adjust the calibrator for 80% tension of the range you are calibrating. Note the voltmeter reading.

---

#### Step 3 Adjust delta K for a voltmeter reading of +8 volts.

- A Select [4] - **Delta K** in the Conditioner Information Menu.
  - B Adjust the delta K value for a voltmeter reading of +8.000 Vdc. Use the arrow keys or type a value until you achieve the voltmeter readout.
    - ◆ If you cannot achieve +8 Vdc, enter a delta K value of 0 and press ESC. Proceed to the special step called **It didn’t work**.
  - C Press the ESC key to return to the menu.
-

#### Step 4 Return to the main menu

Exit the Conditioner Information Menu and save your work.

---

#### It didn't work

You've just discovered that your extensometer requires positive gain and negative delta K. Since the calibrator is set for positive gain (tension) proceed as follows:

- A** Select **[2] - Fine Gain** in the Conditioner Information Menu.
  - B** Adjust the fine gain value for a voltmeter reading of +8.000 Vdc. Use the arrow keys or type a value until you achieve the proper readout.
  - C** Return to Step 1 and calibrate delta K for compression and a negative voltmeter reading.
-

## Task 9 Establishing Shunt Calibration

---

Each range of a resistive bridge type transducer (dc sensor) uses a shunt calibration resistor to check the calibration accuracy of the sensor/conditioner combination. Each dc conditioner supports a sensor cartridge. The sensor cartridge includes 5 shunt calibration resistors for 5 calibrated ranges. Refer to Chapter 2 to set up a sensor cartridge.

**Note** *The shunt calibration procedure can not be performed while the dc conditioner is being used to control the servo loop. Be sure the a control mode using the extensometer is not selected for control.*

---

- Procedure**
1. Zero the extensometer output 311
  2. Execute sensor cal 312
- 

### Step 1 Zero the extensometer output

Adjust the calibrator for a zero voltmeter reading. The extensometer output must be precisely 0.000 volts for a proper shunt calibration.

---

**Step 2 Execute sensor cal**

- A** Select **[3] - Define Conditioner Values** in the Sensor Calibration Main Menu.
- B** Select **[11] - Shunt Cal** in the Conditioner Information Menu.
- C** Enter the value (in ohms) of the resistor associated with the range being calibrated.

Each shunt cal resistor in the sensor cartridge is associated with a range.

See *Standard shunt cal values* on page 77 for additional information.

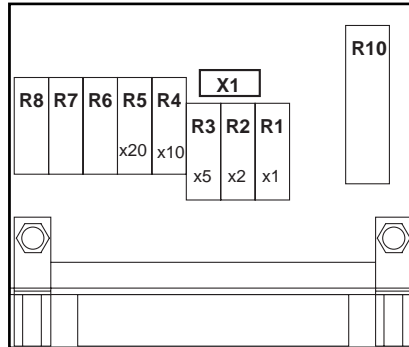

- ◆ The shunt calibration resistor value can be found on the Extensometer Calibration Data Sheet or open the sensor cartridge and record the resistor value.
- ◆ The shunt cal values for the positive and negative are shown along with the shunt cal reference.
- ◆ The shunt cal values should be approximately 80% of the range. Shunt calibration values within 65% and 95% are acceptable.



## Task 10 Recording Data Points

---

This task requires you to manually record the data points, then enter them into the sensor data base.

**Note** You have the option to record data points in 10% increments (refer to Step 3). The default is 20% increments.

---

### Procedure

1. Record the compression data points 313
  2. Calibrate zero and record the tension data points 313
  3. Enter the data points into the data base. 314
  4. Return to the main menu. 314
- 

#### Step 1 Record the compression data points

- A Adjust the calibrator to the zero reference and calibrate zero (Task 6).
  - B Adjust the calibrator between zero and 100% compression of the extensometer's full-scale range three times. This exercises the extensometer to remove any hysteresis.
  - C Adjust the calibrator to 100% compression and record the voltmeter reading. Repeat this for 80%, 60%, 40%, and 20% compression.
- 

#### Step 2 Calibrate zero and record the tension data points

- A Adjust the calibrator to the zero reference and calibrate zero (Task 6).
  - B Adjust the calibrator between zero and 100% tension of the extensometer's full-scale range three times. This exercises the extensometer to remove any hysteresis.
  - C Adjust the calibrator to 100% tension and record the voltmeter reading. Repeat this for 80%, 60%, 40%, and 20% tension.
-

**Step 3 Enter the data points into the data base.**

Select **[4] - Input Calibration Data Points** in the Sensor Calibration Main Menu. Review the table and select the way you want to enter your data points.

MENU	PURPOSE	HELP
1	To change the increment values and enter tension and compression data points separately.	Select <b>[1] Change Data Type and Increment Values</b> . Select the 10% or 20% increment value you want to use. Then select how you want to enter your data points: tension only, compression only, or both.
2	To change existing tension data points.	Select <b>[2] Change Tension Data Points</b> . Edit the data points with new values.
3	To change existing compression data points.	Select <b>[3] Change Compression Data Points</b> . Edit the data points with new values.
4	To enter all 10 data points using 20% increment values.	Select <b>[4] Enter All Data Points</b> . Enter the appropriate data point when prompted.

**Step 4 Return to the main menu.**

Exit the Calibration Data Points Menu and save your work.

---

## Task 11 Calibrating Additional Ranges

---

This task allows you to calibrate additional ranges for the same sensor.

---

### Procedure

1. [Determine a new range](#) 317
  2. [Go back to Task 2](#) 317
  3. [Complete the calibration](#) 317
- 

### Using calibration templates

It is useful to calibrate additional ranges following the initial sensor calibration. The sensor is still mounted to the calibrator and the maximum range values will be similar to additional ranges.

- ◆ All of the entry fields are blank when you first start the program and create a new data base record.
  - ◆ All the entry fields are filled with the previous data base entries when creating a new data base record after another data base has been opened or created. This allows you to modify the data fields unique to the sensor (without having to enter common data).
- 

### Procedural changes

Throughout the calibration procedure, you will find conditional steps that depend on the type of calibration you are doing (the initial calibration, additional range, calibration check). These steps serve as reminders that calibrating additional ranges require different selections. The main procedural changes are:

- ◆ Selecting the range gain (Task 5, Step 5)
  - ◆ Exercising the extensometer travel range (Task 7 and Task 8, Step 1)
  - ◆ Selecting the appropriate shunt calibration resistor (Task 9)
-

## Selecting a range gain multiplier

You establish a sensor range with the range gain selection and the fine gain adjustment in the Conditioner Information Menu.

*For example*, for an extensometer with a full-scale capacity (travel) of  $\pm 4$  mm. The following are traditional ranges

TRAVEL	RANGE	RANGE GAIN
$\pm 4$ mm	100%	x1
$\pm 2$ mm	50%	x2
$\pm 0.8$ mm	20%	x4
$\pm 0.4$ mm	10%	x8
$\pm 0.2$ mm	5%	x16

Selecting an extensometer designed for the desired travel requires less gain and produces higher resolution.

You can create your own selection of ranges. Consider the following sets of ranges.

TRAVEL RANGE	GAIN	TRAVEL RANGE	GAIN
$\pm 4$ mm	x1	$\pm 4$ mm	x1
$\pm 2$ mm	x2	$\pm 3$ mm	x1 or x2
$\pm 1$ mm	x4	$\pm 2$ mm	x2
$\pm 0.5$ mm	x8	$\pm 1$ mm	x4

*For example*, calibrating a  $\pm 3$  mm range falls between two ranges. Calibrating this range may use a range gain of x1 or x2 (with a lot of gain adjustment).

### Step 1 Determine a new range

The first range you calibrate is usually the maximum travel of the sensor (full-scale capacity or 100% range). Additional ranges allow you to perform tests with greater resolution for ranges less than the sensor's maximum travel.

Determine the range you wish to calibrate and note the appropriate range gain multiplier. Each range overlaps the neighboring ranges. Select ranges according to a convenient travel range.

*For example*, using an extensometer with a travel range of  $\pm 4$  mm, you may use the x4 range gain for a  $\pm 1.5$  mm travel range.

RANGE GAIN	RANGE	TRAVEL RANGE
x1	100%	$\pm 4$ mm
x2	50%	$\pm 2$ mm
x4	25%	$\pm 1$ mm
x8	12.5%	$\pm 0.5$ mm
x16	6.25%	$\pm 0.25$ mm

### Step 2 Go back to Task 2

When you have determined what range to calibrate next, return to Task 2 and complete the calibration procedure for the new range.

### Step 3 Complete the calibration

After you have calibrated all the needed ranges, perform the following:

- A** Disconnect the digital voltmeter from the rear panel.
- B** Remove the extensometer from the calibrator.
- C** If you did not save the calibration in Task 10, Step 4, save the calibration now (refer to Task 3).
- D** Enter 99 to exit the calibration program.
- E** Close TestStar. The TestStar interlocks will not work after using the Sensor Calibration program.





# TestStar™ II

Control System

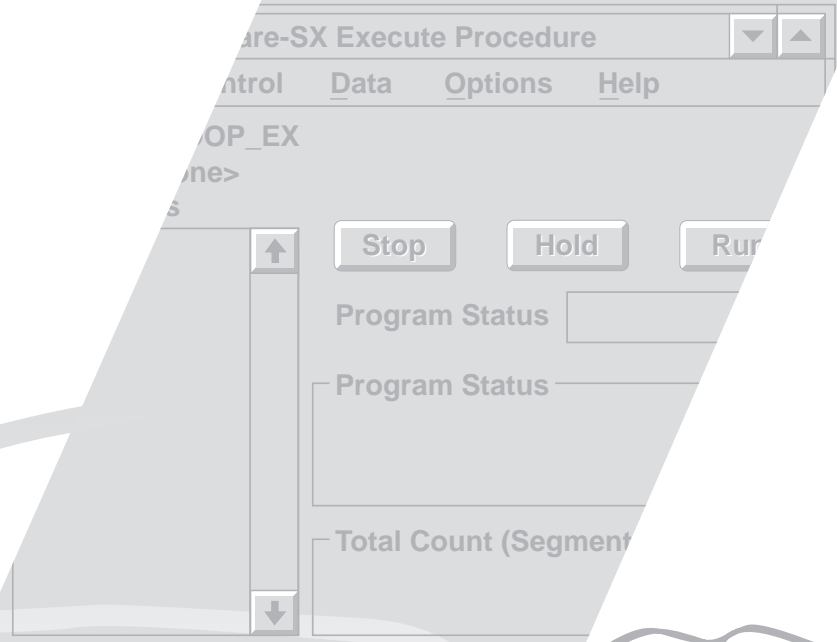

## Chapter 9 Calibration Data



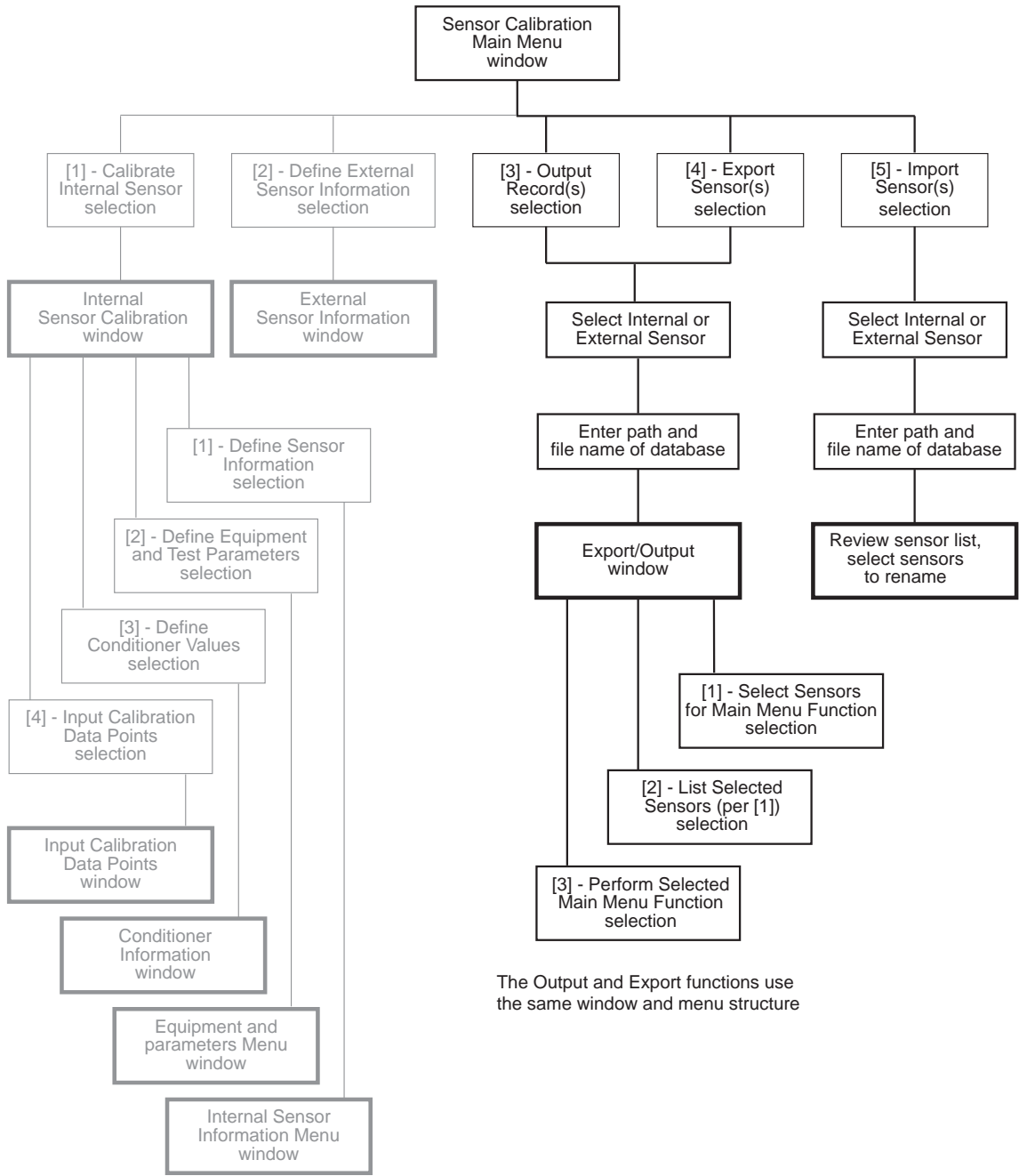

The Output and Export functions use the same window and menu structure



## Chapter 9

# Sensor Calibration Data

---

This chapter how to use the calibration data bases with the Sensor Calibration program. The three sensor calibration program functions described in this chapter operate the same (as shown in the graphic on the back of the tab).

---

<b>Contents</b>	<b>Section A: Printing Calibration Data 323</b>
	<b>Section B: Backing Up Calibration Data 327</b>
	<b>Section C: Retrieving Calibration Data 331</b>

---

**Overview** The Sensor Calibration utility provides three functions for the sensor data base:

- ◆ backup—Export Sensors
- ◆ retrieve—Import Sensors
- ◆ print—Output Records

All sensor calibration data is located in a single file called SENS\_NT.DB (or SENS\_DB.DB for OS/2 systems). The calibration data for each range of a sensor is a data base record. A data base record is an indexed portion of the sensor file.

You should back up your sensor data bases to protect yourself from losing your calibration data. It is good practice to maintain two copies of your sensor calibration data.

Sensors calibrated at MTS for TestStar systems include the calibration data on a disk. Sensor calibration data can be imported to the installed data base.

---

## Output records

The Output Record(s) function prints a sensor data base record or a group of data base records to an ASCII file. The ASCII file can then be printed using the capabilities of your computer operating system. Each data base record (sensor range) prints two pages of information.

---

## Export sensors

The Export Sensor(s) function backs up your calibration data base records. Calibration data base records can be exported to a floppy disk or any other legal path available with your computer.

---

## Import sensors

The Import Sensor(s) function retrieves calibration data base records. Calibration data base records can be imported from a floppy disk or any other legal path available with your computer.

This function is also used when importing sensor calibration data for sensors that are calibrated at MTS Systems Corporation.

---

# Section A: Printing Calibration Data

---

Printing your calibration data allows you to acquire a hard copy of your calibration data. This section describes how to extract the calibration data to an output file and print the output file.

## Procedure

1. Start the Sensor Calibration program 323
  2. Select the output records function 324
  3. Select an internal or external sensor data base 324
  4. Enter a file name for the data base 324
  5. Select the sensors you want to output 325
  6. Review the sensors you have selected for output 325
  7. Output the selected sensor data bases 325
  8. Exit the Sensor Calibration utility 326
  9. Print the output file 326
- 

### Step 1 Start the Sensor Calibration program

Open the Sensor Calibration program in the Utilities group. Observe the WARNING when it is displayed, then press Enter.

You should see this window when you open the Sensor Calibration program.

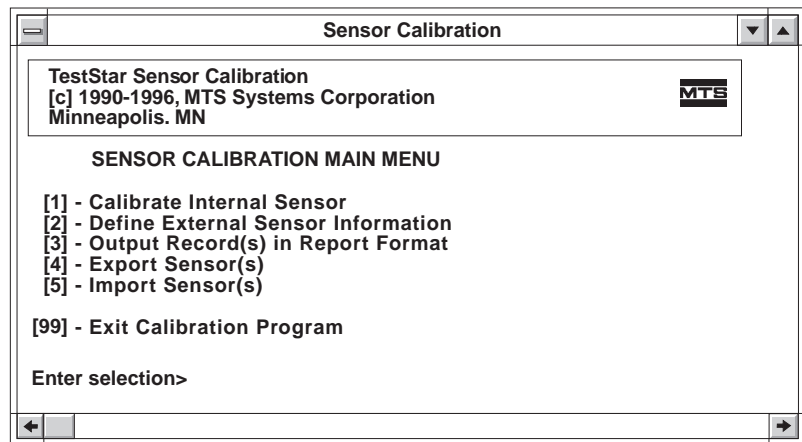

## Step 2 Select the output records function

Select **[3] - Output Records(s) in Report Format** in the Sensor Calibration Main Menu.

---

## Step 3 Select an internal or external sensor data base

An internal sensor record is one that is created with the Create Internal Sensor function of the sensor calibration program. Sensors that are calibrated using the procedures in Chapters 6 - 8 are internal sensors.

An external sensor record is one that is created with the Define External Sensor Information function of the sensor calibration program. Sensors that are defined using the procedure in Chapter 10 are external sensors.

Select **[1] - Internal** to print an internal sensor data base record.

Select **[2] - External** to print an external sensor data base record.

---

## Step 4 Enter a file name for the data base

Type the full path and data base file name of the record you wish to output.

*For example:* **A:SENSOR** identifies the destination of the data base file to be named sensor in drive A.

After the full path and file name are entered, the Setup program displays this window.

The type of sensor (internal or external) is shown in the menu title.

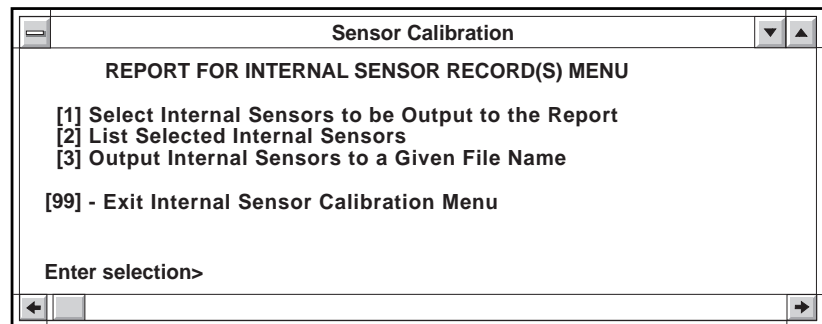

## Step 5 Select the sensors you want to output

- A Select **[1] - Select (internal or external) Sensors to be Output** in the Export Sensor Records Menu.
- B Select a sensor type from the dimension list. This lists all the sensors of the selected dimension type.

*For example,* select [0] Length, a list of all length sensors is shown.

- C Enter a sensor number to select it (or deselect it) for back up. Each selected sensor is identified with an asterisk (\*).
- D Enter 99 to complete the sensor selections. The program then displays the prompt:

Do you want to select (internal or external) sensors of another dimension type?

- ♦ Selecting **Yes** displays the dimension list again. Repeat B, C, and D for each sensor you want to output to a file.
  - ♦ Selecting **No** returns you to the Export Sensor Records Menu.
- 

## Step 6 Review the sensors you have selected for output

Select **[2] - List Selected Sensors** in the Export Sensor Records Menu.

Review the list of sensors you have selected for back up. Return to Step 5 if you want to change the list.

---

## Step 7 Output the selected sensor data bases

Select **[3] - Output Sensors to Given File Name** in the Export Sensor Records Menu. The program then displays the prompt:

If a data base of the same name exists, the program asks if you want to overwrite it or to append it.

**Note** *Once the data base is output to a file, the file can then be printed from your computer operating system.*

---

## Step 8 Exit the Sensor Calibration utility

- A** Enter 99 to return to the Sensor Calibration Main Menu.
  - B** Enter 99 to return to the Utility window. The program asks if you really want to exit.
    - ◆ Enter 1 to exit the program.
    - ◆ Enter 0 to return to the program.
- 

## Step 9 Print the output file

Perform the following to print the output file named in step 4.

- OS/2**
  - ◆ Double-click the Drive A icon. This displays all of the files on the floppy disk.
  - ◆ Select the SENSOR.DB file using the left mouse button. Then click the right mouse button to display the object menu. Select Print.

Or, drag the SENSOR.DB file to the printer icon on the Desktop.

### Microsoft NT

Open the File Manager. Display the contents of the A drive. Select the SENSOR.DB file using the left mouse button. From the File menu, select Print.

---

## Section B: Backing Up Calibration Data

---

Backing up your calibration data allows you to retrieve lost data. You may lose calibration data if you accidentally delete a sensor data base or your hard drive becomes corrupted.

- Procedure**
1. Start the Sensor Calibration program 327
  2. Select the export sensors function 328
  3. Select an internal or external sensor data base 328
  4. Enter a file name for the data base 328
  5. Select the sensors you want to back up 329
  6. Review the sensors you have selected for backup 329
  7. Backup the selected sensor data bases 329
  8. Exit the Sensor Calibration utility 330
- 

### Step 1 Start the Sensor Calibration program

Open the Sensor Calibration program in the Utilities group. Observe the WARNING when it is displayed, then press Enter.

You should see this window when you open the Sensor Calibration program.

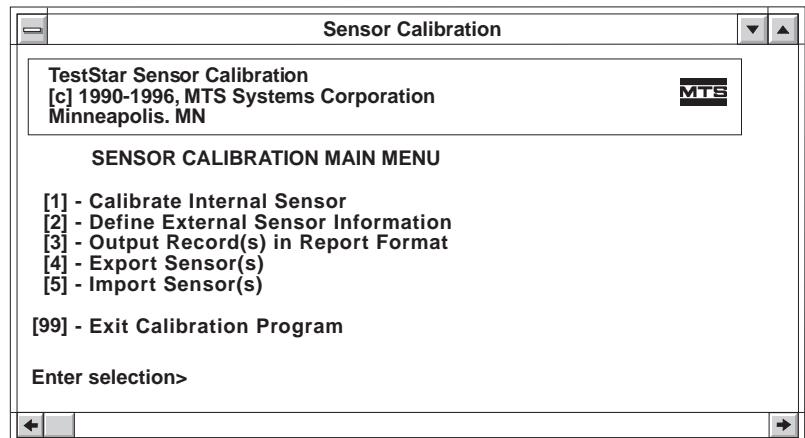

## Step 2 Select the export sensors function

Select [4] - **Export Sensor(s)** in the Sensor Calibration Main Menu.

---

## Step 3 Select an internal or external sensor data base

An internal sensor record is one that is created with the Create Internal Sensor function of the sensor calibration program. Sensors that are calibrated using the procedures in Chapters 8 - 10 are internal sensors.

An external sensor record is one that is created with the Define External Sensor Information function of the sensor calibration program. Sensors that are defined using the procedure in Chapter 11 are external sensors.

Select [1] - **Internal** to export an internal sensor data base record.

Select [2] - **External** to export an external sensor data base record.

---

## Step 4 Enter a file name for the data base

Type the full path and data base file name for the destination file.

*For example:* A:SENSOR.BAK identifies the external data base to be named sensor.bak in drive A.

After the full path and file name are entered, the Setup program displays this window.

The type of sensor (internal or external) is shown in the menu title.

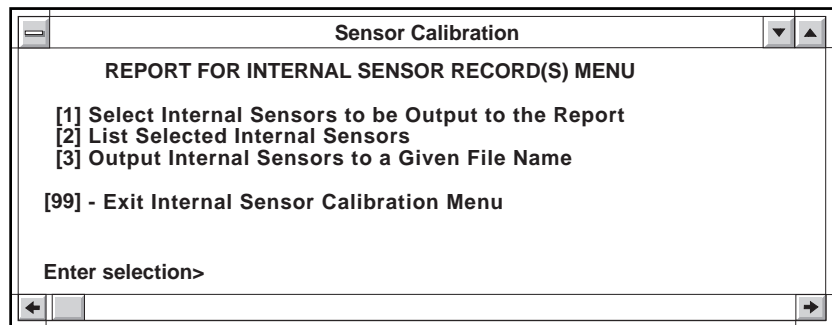



## Step 5 Select the sensors you want to back up

- A** Select **[1] - Select Internal Sensors to be Exported** in the Export Sensor Records Menu. This displays the dimension list.
- B** Select a sensor type from the dimension list. This lists all the sensors of the selected dimension type.

*For example,* select [0] Length, a list of all length sensors is shown.

- C** Enter a sensor number to select it (or deselect it) for backup. Each selected sensor is identified with an asterisk (\*).
- D** Enter 99 to complete the sensor selections. The program then displays the prompt:

Do you want to extract sensors of another dimension type?

- ♦ Selecting **Yes** displays the dimension list again. Repeat B, C, and D for each sensor you want to backup.
  - ♦ Selecting **No** returns you to the Export Sensor Records Menu.
- 

## Step 6 Review the sensors you have selected for backup

Select **[2] - List Selected Sensors** in the Export Sensor Records Menu.

Review the list of sensors you have selected for backup. Return to Step 5 if you want to change the list.

---

## Step 7 Backup the selected sensor data bases

Select **[3] - Export Sensors to Given File Name** in the Export Sensor Records Menu. The program then displays the prompt:

Do you want to delete from the main data base the sensors you selected?

- ♦ If you want the selected sensor data bases removed from the TestStar source directory when they are copied, select **Yes**.
- ♦ If you want to leave the selected sensor data bases as they are, select **No**.

**Note** *If a data base of the same name exists, the program asks if you want to overwrite it or to append it.*

---

## Step 8 Exit the Sensor Calibration utility

- A** Enter 99 to return to the Sensor Calibration Main Menu.
  - B** Enter 99 to return to the Utility window. The program asks if you really want to exit.
  - ◆ Enter 1 to exit the program.
  - ◆ Enter 0 to return to the program.
-

# Section C: Retrieving Calibration Data

---

Sensors calibrated at MTS for TestStar systems include the calibration data on a disk. You download the calibration data and merge it with your main calibration data base. You can also retrieve a data base that you had backed up.

- Procedure**
1. Start the Sensor Calibration program 331
  2. Select the import sensors function 332
  3. Select an internal or external sensor data base 332
  4. Enter a file name for the data base 333
  5. Review the list of sensors to be imported 333
  6. If necessary, rename the sensors 333
  7. Exit the Sensor Calibration utility 334
- 

## Step 1 Start the Sensor Calibration program

Open the Sensor Calibration program in the Utilities group. Observe the WARNING when it is displayed, then press Enter.

You should see this window when you open the Sensor Calibration program.

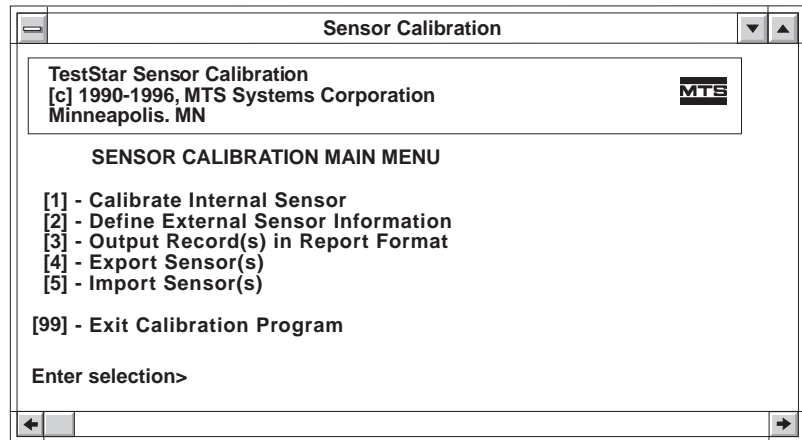

## Step 2 Select the import sensors function

Select **[5] - Import Sensor(s)** in the Sensor Calibration Main Menu.

---

## Step 3 Select an internal or external sensor data base

An internal sensor record is one that is created with the Create Internal Sensor function of the sensor calibration program. Sensors that are calibrated using the procedures in Chapters 8 - 10 are internal sensors.

An external sensor record is one that is created with the Define External Sensor Information function of the sensor calibration program. Sensors that are defined using the procedure in Chapter 11 are external sensors.

Select **[1] - Internal** to export an internal sensor data base record.  
Select **[2] - External** to export an external sensor data base record.

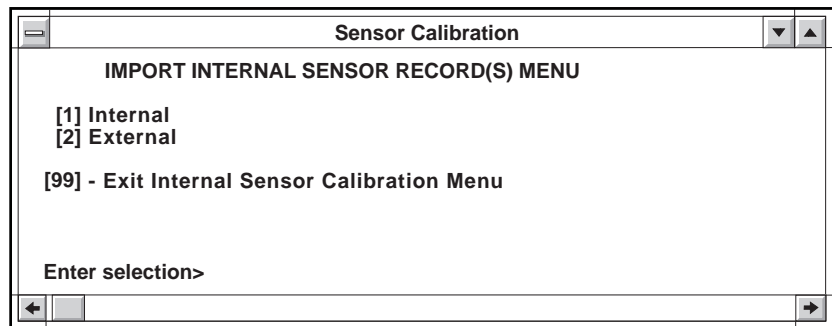

### CAUTION

**This function will take all sensors from the selected data base and add them to the main data base. The retrieval program will warn you of any duplicate sensor records.**

Duplicate sensor records are records that use same file name for the sensor in the selected data base and the main data base. A list of any duplicate sensor records will be displayed.

You will have the opportunity to rename duplicate sensor names or overwrite the current sensor record with the imported sensor record.

---

Select **[0] - No** if you wish to exit the program now.  
Select **[1] - Yes** if you wish to continue importing sensors.

---

#### Step 4 Enter a file name for the data base

Type the full path and data base file name for the source file.

*For example:* A:SENSOR.BAK identifies the data base named sensor.bak in drive A.

The program compares the source file with the main data base to create a list of duplicate sensor files. If a duplicate sensor file is found, the program displays a message that describes what will happen if a duplicate sensor file is not renamed.

Press Enter to continue.

---

#### Step 5 Review the list of sensors to be imported

The program displays a list of the sensors to be imported. Duplicate sensor files are identified with an asterisk (\*). These files are selected for renaming.

You can select or de-select sensor files for renaming. Enter the sensor number from the list of sensors to change the renaming status of the sensor.

*For example,* if a sensor name is identified with an asterisk (\*) it is selected for renaming. Entering that sensor's number will remove the asterisk and it will not be renamed. Entering that sensor's number again will add the asterisk so the sensor file can be renamed.

Enter 99 when the sensor list for renaming is complete.

---

#### Step 6 If necessary, rename the sensors

Each sensor selected for renaming displays the following:

##### **Renaming the sensor**

**Previous Sensor Name:** *the name of the sensor file to be imported*

Enter NEW name for the sensor

Type the name you wish to call the sensor data base record.

---

## Step 7 Exit the Sensor Calibration utility

- A** Enter 99 to return to the Sensor Calibration Main Menu.
  - B** Enter 99 to return to the Utility window. The program asks if you really want to exit.
  - ◆ Enter 1 to exit the program.
  - ◆ Enter 0 to return to the program.
-



# *TestStar™ II*

Control System

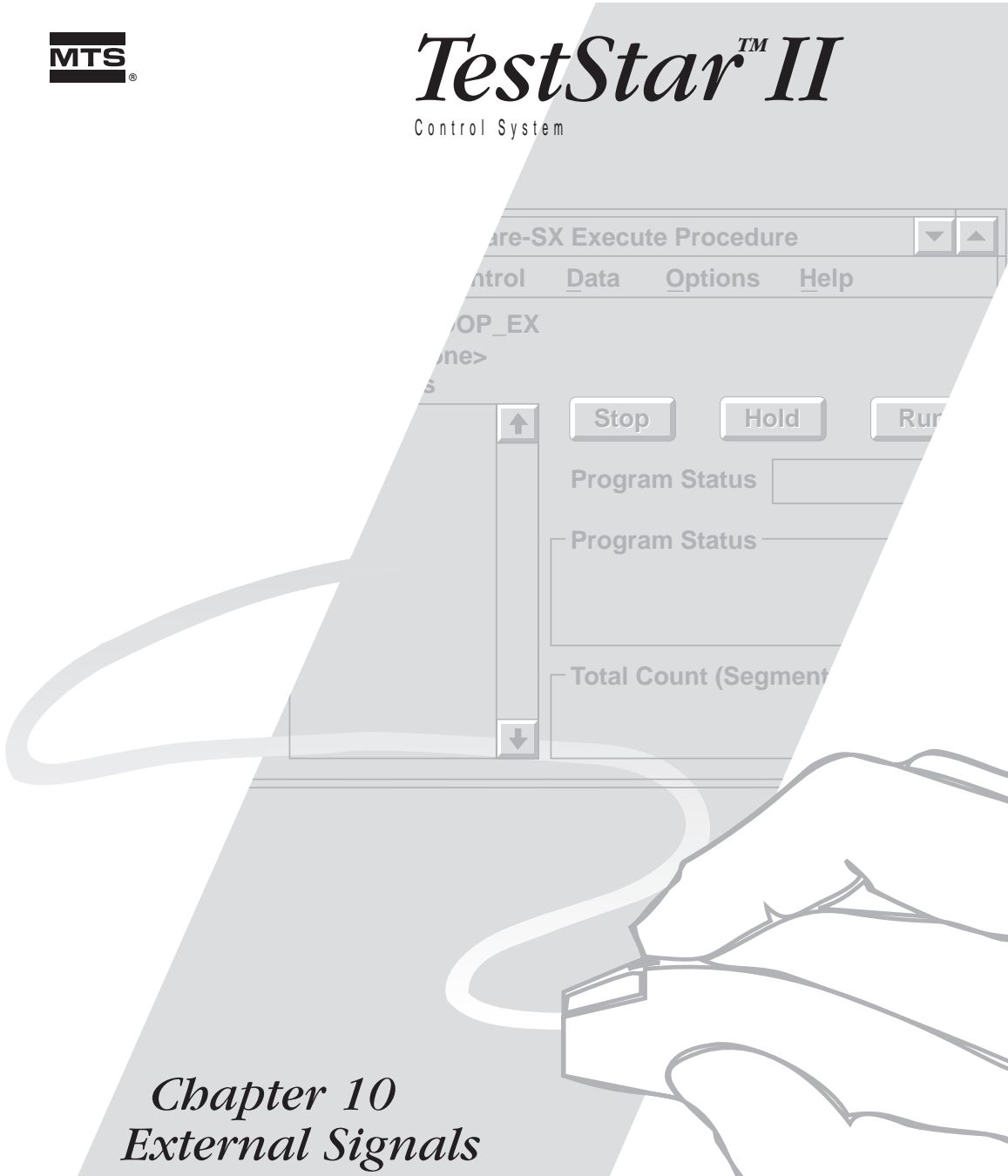

## *Chapter 10 External Signals*

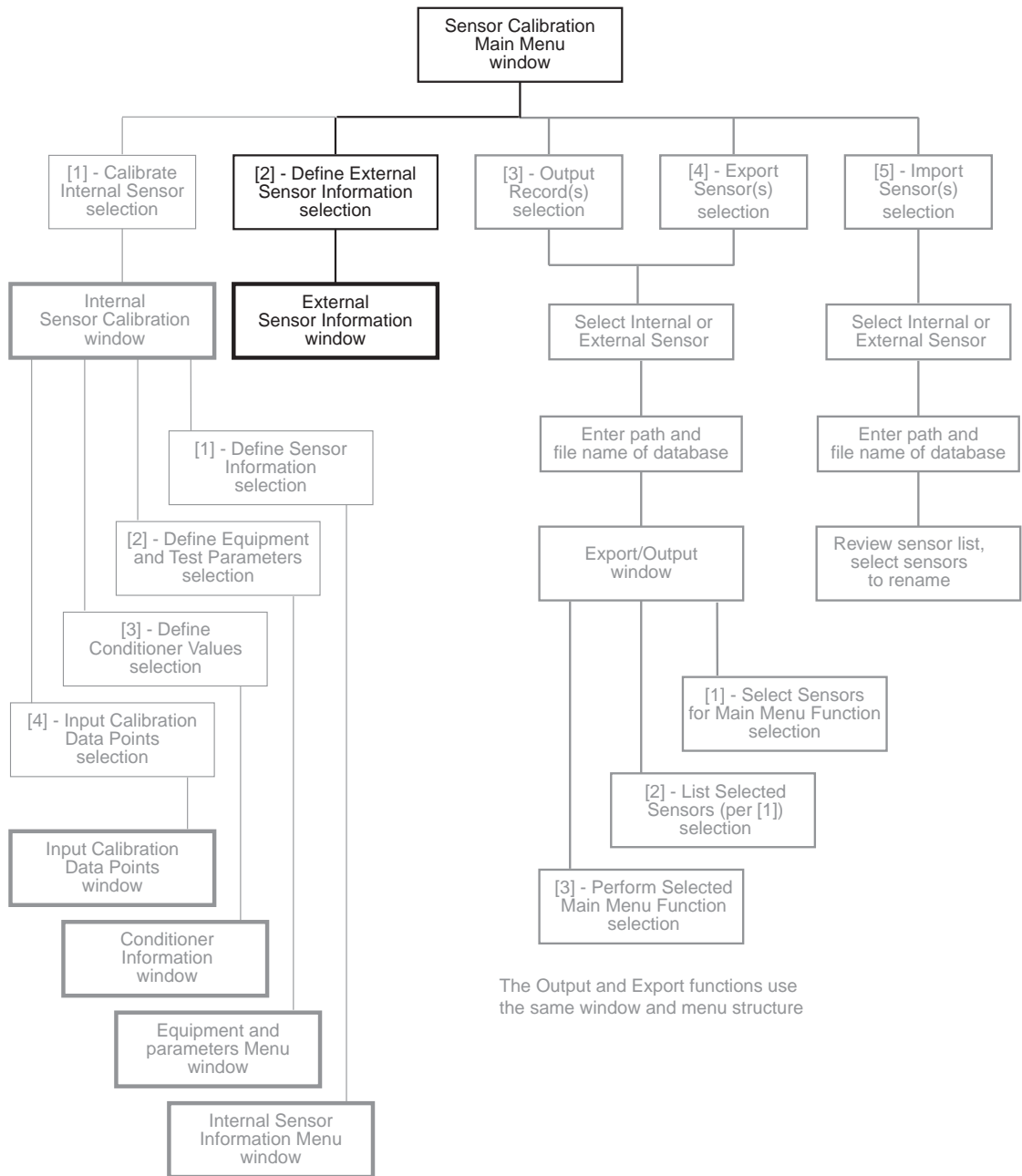



## Chapter 10

# External Signals

---

The digital controller can use up to 8 external input signals. An external input signal can be used two ways:

- ◆ As a test command source from an external program device such as a function generator or profiler.
- ◆ As a feedback signal from an external transducer conditioner. External conditioners are NOT located in the digital controller.

Both types of external signals are set up in the same way, except when defining control modes.

---

### Contents

General Information 337

Abbreviated Procedure 341

Detailed Procedure 342

    Connecting External Equipment 342

    Defining a Permanent External Signal 346

    Defining an External Signal 350

    Using External Signals 354

---

### Prerequisite

An external test command signal or sensor feedback signal must be within  $\pm 10$  volts.

You must have the Extended Analog I/O option installed if you want more than eight inputs. See Chapter 2, Section F for information about this option.

---

## How it works

There is very little difference between an external sensor signal and an external command signal. Both signals are within  $\pm 10$  volts. Both signals are produced by equipment external to the digital controller.

Depending on its source, an external signal can provide feedback or a command for a control mode.

An external sensor signal is a processed feedback signal to control the servo loop.

An external command signal produces a test program command.

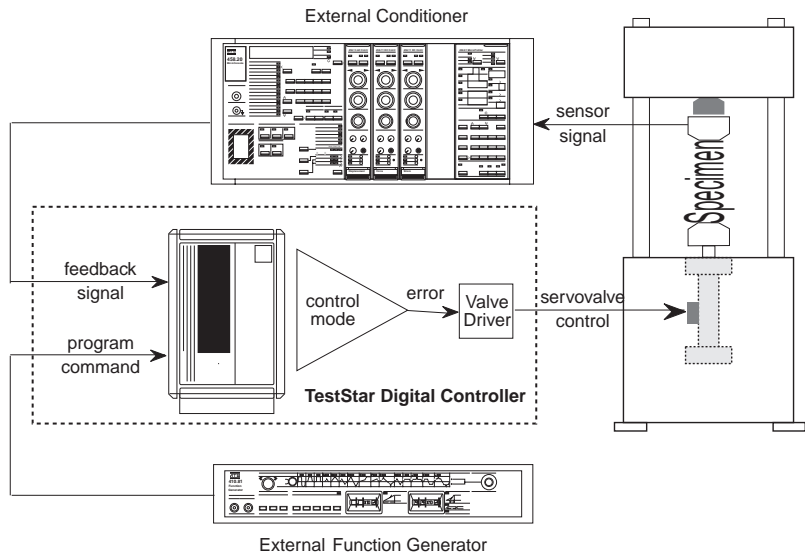

There are two differences between the signals. The source of the signal determines how the signal can be used.

- ◆ An external command is a test control signal generated by an external device such as a function generator or profiler. An external command provides the command source for a control mode.
- ◆ An external sensor signal is a transducer signal that is processed by an external device such as an ac or dc conditioner. An external sensor provides the feedback for a control mode.

## Before you begin

You need to determine some information about the external signal.

- ◆ For an external command, you need to know what its program is designed to do. *For example*, if the command was designed to use a displacement control mode, the signal should be defined with compatible units such as millimeters or inches.
- ◆ For an external sensor signal, you need to know what kind of sensor produced the signal. *For example*, if a force transducer produced the signal, the signal should be defined with compatible units such as Newton's or lbf.

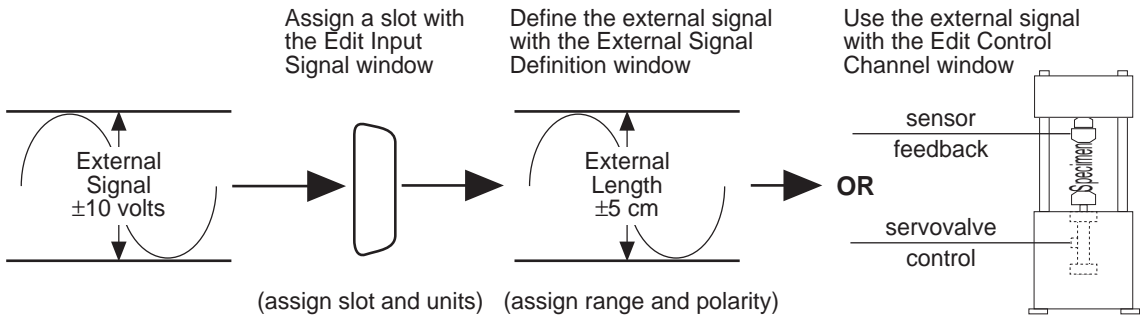

External command and sensor signals are defined the same (except at the control mode).

Also, the sensor definition can be accomplished in either of two ways.

- ◆ A temporary record can be defined with the Define External Sensor window. Use this method if you want to use the signal with the current TestStar configuration only. This procedure is part of Task 3.

*For example*, if the external command is associated with a specific test, so the temporary definition would be the most appropriate procedure.

- ◆ A permanent record can be created with the Sensor Calibration program. Use this method if you want the signal to be available for all TestStar configurations. This procedure is described in Task 2.

*For example*, if the external sensor is associated with multiple tests, using the sensor calibration program would be the most appropriate method.

## Abbreviated procedure

The abbreviated procedure provides a concise sequence to set up an external command source or external sensor for those who are experienced with TestStar.

The abbreviated procedure lists the tasks and steps of the procedure. Each step includes the page number of the detailed procedure where the step is fully explained.

---

## Detailed procedure

The detailed procedure provides an enhanced sequence of the procedure for those who are inexperienced with TestStar.

The detailed procedure is a step-by-step procedure arranged by tasks. Each task is a general group of steps. Each step includes detailed information as to how to complete the step. Some steps include examples or helpful information.

---

# Abbreviated Procedure

---

## Connecting External Equipment10-6

- Identify the external equipment10-6
- Determine which rear panel connector to use10-8
- Connect the external equipment to the digital controller10-9

## Defining a Permanent External Signal10-10

- Start the Sensor calibration program10-10
- Open the external sensor information screen10-11
- Create or open a data base record10-11
  - Enter any optional information for the data base record10-12
- Save the data base record10-13
- Exit the Sensor Calibration program10-13

## Defining an External Signal10-14

- Open the TestStar application10-14
- Open the Edit Input Signal window10-14
- Define an external input signal10-15
- Assign a sensor signal10-16
- Define a temporary signal10-16

## Using External Signals10-18

- External sensor characteristics10-18
- External command characteristics10-19

## Task 1 Connecting External Equipment

---

This describes how to connect an external command source or external sensor to the digital controller. Up to 8 external signals can be input to the digital controller.

### Procedure

1. Identify the external equipment 342
  2. Determine which rear panel connector to use 344
  3. Connect the external equipment to the digital controller 345
- 

### Step 1 Identify the external equipment

Determine if your external equipment is used as an external command source or as an external sensor.

#### External command

You need to set up your external command source so it can provide an appropriate signal to the digital controller.

**Note** All MTS command sources issue  $\pm 10$  volt signals.

COMMAND SOURCE	COMMENTS
410.81 Function Generator	The command output is available at rear panel connector J1 of the Function Generator. Set the rear panel Reference switch to Int.
418.91 Micro Profiler	The command output is available at rear panel connector J103A or J103B of the Micro Profiler.
458.91 Micro Profiler	The command output is available at rear panel connector J603 and J601 on a Micro Console (assuming a standard configuration). Remove the jumper from pins 3 and 4 of J3A (if necessary).
Other Command Sources	Identify the command output connector. Also identify the full-scale output voltage.

## External sensor

You need to set up your external sensor source so it can provide an appropriate signal to the TestStar digital controller.

**Note** All MTS feedback sources can produce  $\pm 10$  volt signals.

COMMAND SOURCE	COMMENTS
408.81 Testing Panel (408.82 DC Conditioner)	The sensor (transducer) output is available at rear panel connector J201 or J202 (depending where the conditioner is installed).
409.81C Temperature Controller	The Temperature output is available at connector J1
448.82/85 Test Controller (448.21 DC Conditioner 448.22 AC Conditioner)	The sensor (transducer) output is available at rear panel connector J335. Conditioner jumpers should be set as follows: X1, 2&3; X2, 2&3.
458.10/.20 Micro Console (458.11/.12/.13/.14 AC and DC Controllers)	The sensor (transducer) output is available at rear panel connector Jx03 of a Micro Console. Connector Jx03 represents the module location (J100 - J600). Micro Console jumper Jx00 should be set to 1&2 (the standard setting)
Other Command Sources	Identify the sensor (transducer) output connector. Also identify the full-scale output voltage.

## Step 2 Determine which rear panel connector to use

An external command or external sensor can be input through one of several rear panel connectors on the digital controller. Review the following and select one of the inputs for the external command.

You can use connectors J42, J77, or J78 to input an external signal.

More than one external command source can be input to the digital controller.

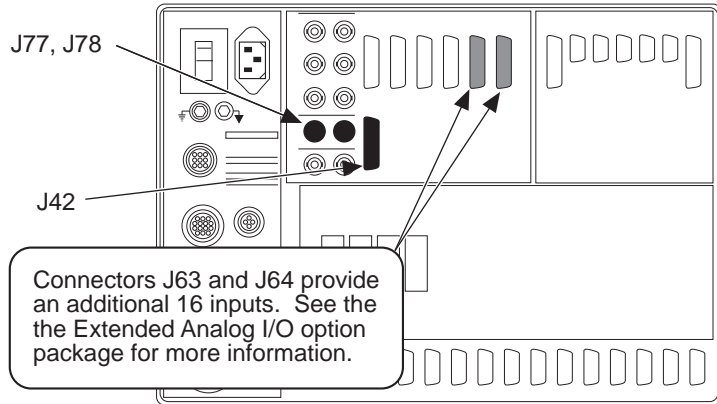

- ◆ Connectors J77 (Input 7) and J78 (Input 8) each allows a single input signal. These are BNC-type connectors.
- ◆ Connector J42 allows up to 8 external input signals. This is a 'D' style connector.
- ◆ Inputs 7 and 8 of connector J42 are the same inputs as connectors J77 and J78. Be sure that only one input source is connected.
- ◆ A maximum of eight external inputs exist through several input locations. Only one input connection for each input channel.  
*For example*, if you use connector J77, you cannot use connector J42 pins 14 and 15.

**Note** You need to know which input channel your selection represents when you define the external input with the Edit Input Signals window. Input channels 1 - 8 pertain to slots 7 - 14 respectively.

### EXTERNAL INPUT CHANNELS

1	2	3	4	5	6	7	8
J42-1,2	J42-3,4	J42-5,6	J42-7,8	J42-9,10	J42-11,12	J42-14,15	J42-16,17
						J77	J78



### **Step 3 Connect the external equipment to the digital controller**

Once you've decided which connector to use, you must either fabricate or buy an appropriate cable.

Go to Chapter 3 in the TestStar Installation Manual and review the cabling information about the connector you intend to use. The chapter on cabling also provides cable specifications.

Connect the external sensor cable between the digital controller and the external equipment.

---

## Task 2 Defining a Permanent External Signal

---

This task is optional. We recommend that external sensor signals become part of your sensor data base because that makes them available for any TestStar configuration.

An alternate way of to define an external signal is explained in Task 3. That method of defining an external signal saves the information as part of the TestStar configuration file. The alternate method is most appropriate for external command signals or external sensors that are needed for specific tests only.

---

### Procedure

1. Start the Sensor calibration program 346
  2. Open the external sensor information screen 347
  3. Create or open a data base record 347
  4. Enter any optional information for the data base record 348
  5. Save the data base record 349
  6. Exit the Sensor Calibration program 349
- 

### Step 1 Start the Sensor calibration program

Open the Sensor Calibration program in the Utilities group. Observe the WARNING when it is displayed, then press Enter.

You should see this window when you open the Sensor Calibration program.

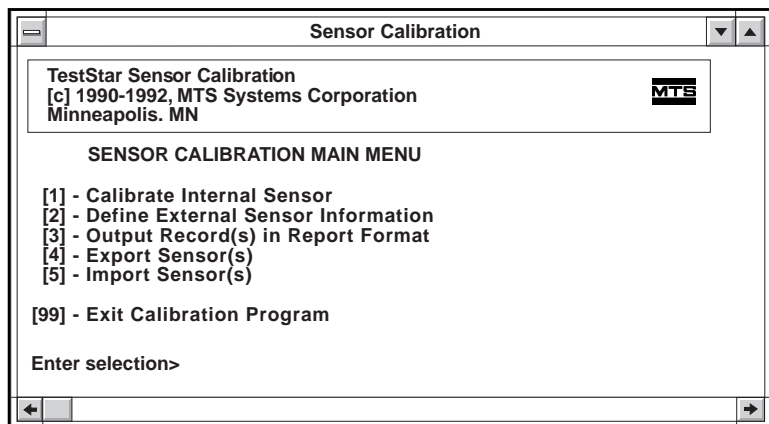

## Step 2 Open the external sensor information screen

Select **[2] - Define External Sensor Information** in the Sensor Calibration Main Menu.

---

## Step 3 Create or open a data base record

Create an external data base record if you are entering the external sensor information for the first time.

- ◆ Select **[1] - Create New DB Record** in the Sensor Information Menu

Open an external data base record if you need to change the external sensor information.

- ◆ Select **[2] - Locate Existing DB Record** in the Sensor Information Menu.

Only the first two selections are shown when this window opens.

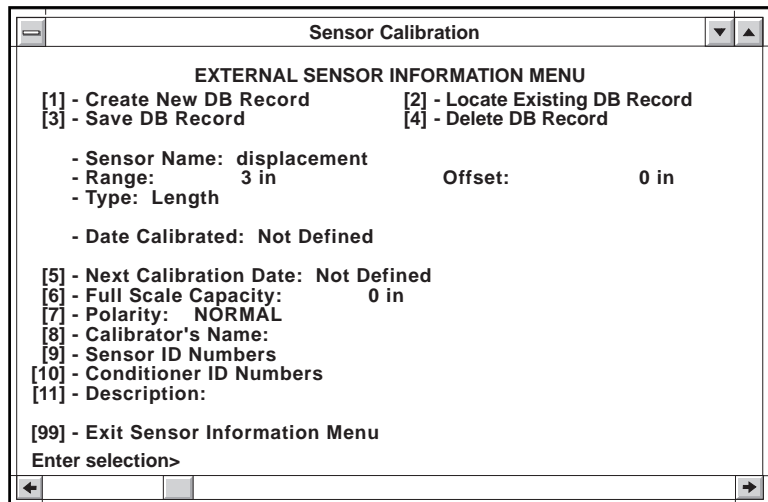

*Continued...*

### Step 3 (continued)

You will be prompted to provide the following information about the sensor you are defining.

PROMPT	INFORMATION
Dimension	Select the appropriate dimension for the sensor.
Name	The Model number or name of the sensor.
Range	The maximum capacity of the external sensor or reduced capacity scaled for $\pm 10$ volts.
Units	The preferred units for the dimension of the signal.
Offset	Enter 0 if the offset is unknown (in volts). This can be changed later (see Task 3, Step 5).
Input #	Enter the input number 1-8 as determined in Task 1, Step 2.
APC	The actuator positioning control channel number (if more than one).

### Step 4 Enter any optional information for the data base record

The following is not required for the sensor data base. However, you may want to record important information about the sensor definition.

MENU	PURPOSE	HELP
5	To record the next calibration date	Select <b>[5]—Next Calibration Date</b> and enter the next date the sensor should be calibrated (typically 1 year between calibrations).
6	To record the sensor's full-scale capacity	Select <b>[6]—Full Scale Capacity</b> and enter the full-scale capacity of the sensor.
7	To record a customer name	Select <b>[7]—Customer Name</b> and enter the name of your company.
8	To record a description	Select <b>[8]—Description</b> . You can type up to 254 characters of additional information for the sensor data base.

## Step 5 Save the data base record

The data base record is associated with a sensor (sensor name) and the range you are calibrating. Saving the data base record either creates a new record or overwrites an existing record.

Select **[3] - Save DB Record** in the Sensor Information Menu.

- ◆ The prompt warns you if another sensor/range record of the same name will be overwritten.
  - ◆ Select **Yes** to save the record.
  - ◆ Select **No** to return to the Sensor Information menu without saving the record.
- 

## Step 6 Exit the Sensor Calibration program

- C** Type 99 to exit the External Sensor Information menu and return to the Sensor Calibration Main Menu.
  - D** Type 99 to exit the sensor calibration program.
  - E** Go to Task 3 and follow the Assign Sensor selection in Step 3, then follow Step 4A.
-

## Task 3 Defining an External Signal

---

This task assigns the external signal to one of the eight possible rear panel connectors (J7 - J14).

### Procedure

1. Open the TestStar application 350
  2. Open the Edit Input Signal window 350
  3. Define an external input signal 351
  4. Locate or create a data base for the external signal 352
  5. Determine if offset is needed 353
- 

#### Step 1 Open the TestStar application

From the OS/2 desktop, double-click the TestStar folder to open it. Double-click the TestStar icon to start it. After a moment you will be prompted for your name and password.

---

#### Step 2 Open the Edit Input Signal window

From the main TestStar window, select the Edit menu, then select Input Signals. This opens the Edit Input Signals window.

---

### Step 3 Define an external input signal

This step links the rear panel connector to an input signal and assigns units to the signal.

The Signal Selection may include Extended selections if the Extended Analog I/O option is installed.

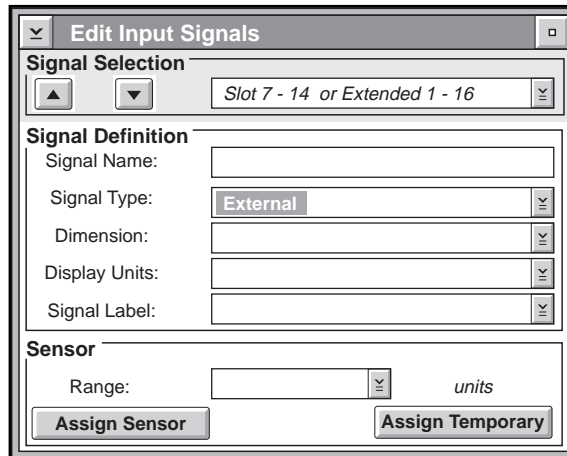

- A Select a slot (7 - 14). This corresponds with the signal connection (see Task 1, Step 2).
- B If you want, name the input signal anything you like.
- C Select the external signal type. This displays a Sensor area at the bottom of the window.
- D Select a dimension that is appropriate for the signal.
- E Select the units you want for the signal.
- F Press the Assign Sensor pushbutton or the Define Special pushbutton.

Assign Sensor

Assign Temporary

- ♦ If you defined a permanent external signal in Task 2, press the Assign Sensor pushbutton and go to Step 4 and perform “Locate calibration data base” on the next page.
- ♦ If you did not define a permanent external signal in Task 2, press the Assign Temporary pushbutton and go to Step 4 and perform “Create temporary data base” on the next page.

#### Step 4 Locate or create a data base for the external signal

The calibration information may be recorded as part of the permanent data base (Assign Sensor window) or with the TestStar configuration file (Define External Sensor).

##### Locate calibration data base

The Assign Sensor window lists sensors based on the signal type selection in the Edit Input Signals window. Only external sensors in the data base created with the Sensor Calibration program are listed.

Use this window to define a temporary external signal.

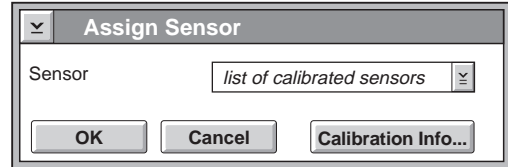

##### Create temporary data base

Use this window to define a temporary external signal.

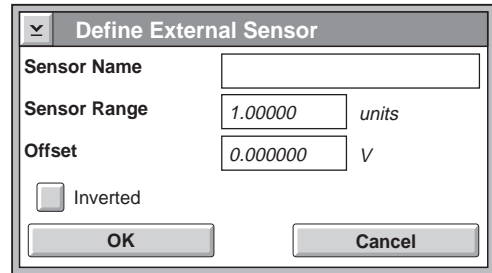

- A Enter a sensor name. We recommend you use a name that identifies the signal as a command or feedback signal.
- B Enter a value that represents the full-scale capacity of the external signal. This defines the range of the sensor (what  $\pm 10$  volts means)

*For example*, assume you have an external sensor signal that has a capacity of  $\pm 5$  cm. Enter 5 in the Range entry field.

*Another example*, assume your external command signal is designed to cycle  $\pm 10$  N with  $\pm 5$  volts. Since the maximum 10 volt signal represents 20 N, enter 20 in the Range entry field.

- C Press the OK pushbutton.
-



## Step 5 Determine if offset is needed

This step determines if you need to edit the signal definition to compensate for any signal offset

- A** From the main TestStar window, select the Display menu, then select Input Signals. This opens the Display Input Signals window where you can monitor the external input signal.
  - B** Set up the external device for a null output.
  - C** Monitor the output of external input signal in the Display Input Signals window. If the output is not zero, note the value.
  - D** Enter the offset value to the external sensor definition.
- ◆ If you did not define a permanent external signal in step 2, return to the Define External Sensor window and enter the offset value in the Offset entry field. Press the OK pushbutton when complete.
  - ◆ If you defined a permanent external signal in step 2, return to the Sensor Calibration program and enter the offset value (Task 2, Step 3).
-

## Task 4 Using External Signals

---

The external signals are available throughout TestStar just as any other input signal. However, external signals do have some characteristics that you should be aware of.

### Remember

TestStar doesn't know the difference between an external command signal and an external feedback signal. It is up to you to know what the signals are that you define. It is a good idea to name your external signals with meaningful names like Cyclic Command or Sensor 458.

### CAUTION

---

**Using an external command signal as control mode feedback can cause unexpected results.**

A command signal that is used as a feedback signal will confuse the control mode by producing a signal that does not represent (or even resemble) the expected feedback. This will cause the control mode to wildly drive the command signal to the servovalve.

So be careful when you select external signals. *Be sure* you know what each external signal is designed to do.

---

The following topics address characteristics unique to each type of external signal.

### External sensor characteristics

An external sensor signal is available for any TestStar control mode, just like any other sensor signal. The following are items work differently than the internal sensor signals.

- ◆ You cannot zero an external sensor signal from the Adjust Input Signals window or the Display Input Signals window. Use the offset adjustment in the Define External Sensor window to set the zero reference of the external sensor signal.
  - ◆ External DC-type sensors do not have shunt calibration available. Shunt calibration resistors are usually connected to the conditioner and external conditioners are not part of the TestStar circuitry.
-

## External command characteristics

An external command signal is available for any TestStar PIDF control mode, just like the segment generator (function generator). The following are items work differently than the standard segment generator.

- ◆ The Ampl. ramp time selection in the Command Menu Options window of the Function generator is enabled. This is provided to slowly increase the amplitude of the signal for a bumpless transfer to the external input.
  - ◆ The Wave shape selection in the Command Menu Options window of the Function generator is disabled. The wave shape is established at the external command source.
  - ◆ The Frequency control in the Function Generator window is disabled. The frequency is established at the external command source.
  - ◆ The Amplitude control in the Function Generator window is scaled for percentage of full-scale. The control should be set to 100%; it can also be used to reduce the overall amplitude of the external command.
-





# *TestStar™ II*

Control System

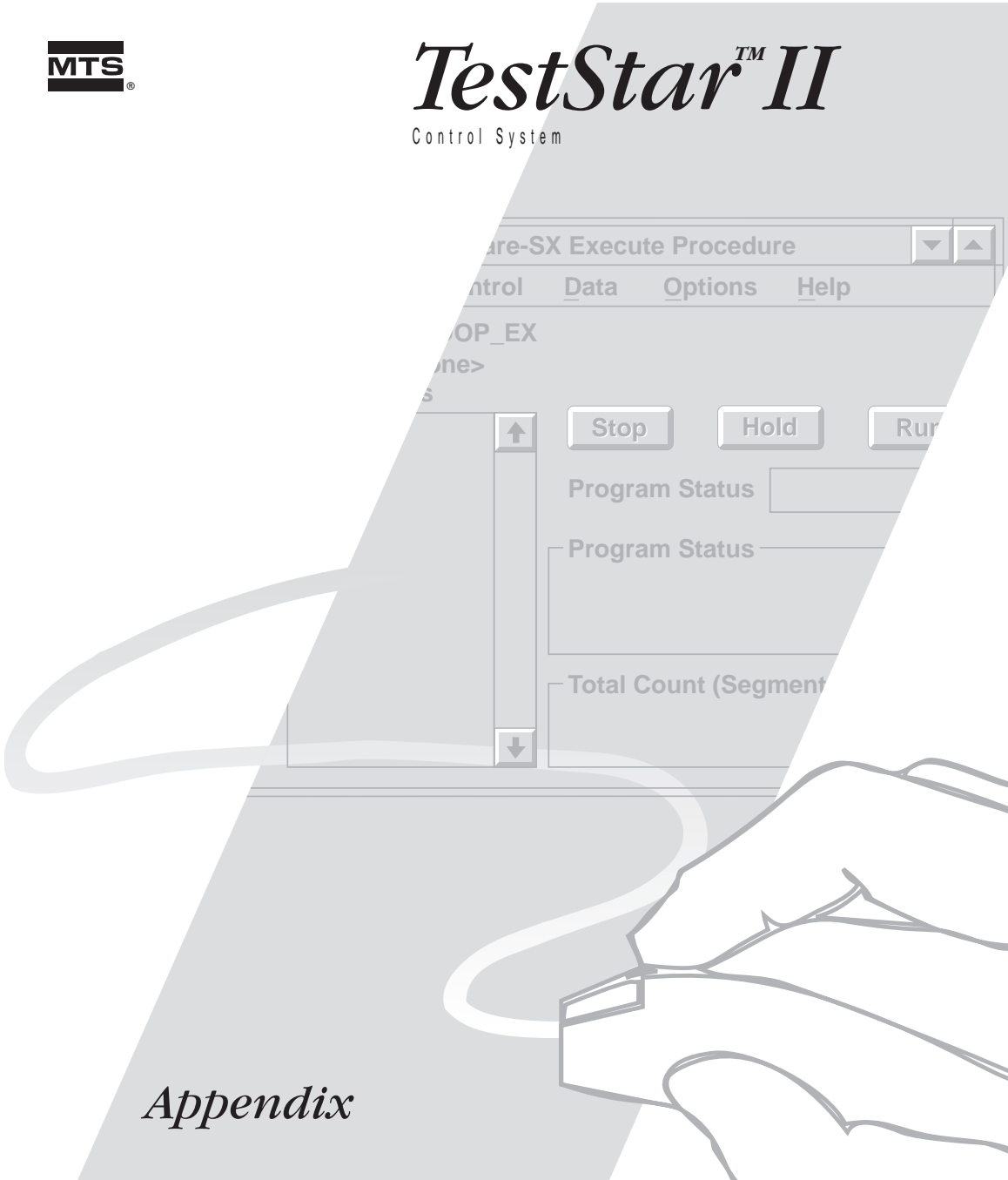

*Appendix*

# Appendix

---

**Contents**      **Appendix A**      [Hardware Specifications](#)      359

Lists the electronic specifications for each of the modules that make up the digital controller.

**Appendix B**      [Servovalve Adjustments](#)      370

Describes how to perform electronic adjustments for servovalves.

**Appendix C**      [System Calibration Program](#)      391

Describes the use of the System Calibration program that calibrates the digital controller.

**Appendix D**      [Diagnostics Program](#)      394

Describes the use of the Diagnostic program that checks each module of the digital controller.

**Appendix E**      [Load Unit Interface](#)      399

Describes how to interface with the most common MTS load units. Cabling and required hardware packages are specified.

**Appendix F**      [Interlock Diagnostic Program](#)      402

Describes how to determine the exact cause of a hydraulic interlock.

**Appendix G**      [Strain Gage Calibration](#)      405

Describes how to calibrate strain gages and how to use bridge completion resistors.

---

## Appendix A:

# Hardware Specifications

---

This appendix contains the digital controller hardware specifications.

<b>Contents</b>	<b>Model 490.01 Chassis Power Supply Module</b>	<b>360</b>
	<b>Model 490.14/.17 Valve Driver Modules</b>	<b>361</b>
	<b>Model 490.21 DC Conditioner Module</b>	<b>362</b>
	<b>Model 490.22 AC Conditioner Module</b>	<b>364</b>
	<b>Model 490.30 Workstation Communication Interface</b>	<b>366</b>
	<b>Model 490.40 Analog I/O Module</b>	<b>367</b>
	<b>Model 490.50 Processor Module</b>	<b>368</b>
	<b>Model 490.60 Hydraulic I/O Module</b>	<b>369</b>

---

### Nonstandard abbreviations

Most of the abbreviations used in the specifications are universal. The following is a list of those abbreviations that may be not be well known.

Cal fac	=	Calibration Factor
DAC	=	Digital-to-Analog Converter
DMA	=	Direct Memory Access
ex	=	Excitation
LSB	=	Least Significant Bit
max	=	Maximum
min	=	Minimum
NO/NC	=	Normally Open/Normally Closed contacts
REF	=	Reference
RTI	=	Referenced To Input
RTO	=	Referenced To Output
x	=	Multiplier
xdcr	=	Transducer

---

## Model 490.01 Chassis Power Supply Module

PARAMETER	SPECIFICATION
<b>Environmental</b>	
Temperature	5°C to 40°C
Relative humidity	20% to 95%, noncondensing
<b>Power Input</b>	
Input voltage	90 - 125 Vac, 200 - 250 Vac; auto ranging
Input surge	<68 amps from cold start
Static current	5 A at 115 Vac; 2.5 A at 230 Vac (max)
Hold up time	20 ms from loss of nominal AC power
Circuit protection	short circuit protection by duty cycle current foldback with automatic recovery
<b>Power Output</b>	
Voltages+5 Vdc	+0.1 to -0.05 Vdc; 20 A
+15 Vdc	±0.25 Vdc; 5 A
-15 Vdc	±0.25 Vdc; 5A
+25 Vdc	±1.2 Vdc; 6 A
<b>Indicators</b>	
Voltages	trip range:
+5 Vdc	3.9 to 4.5 Vdc
+15 Vdc	11.6 to 13.4 Vdc
-15 Vdc	-11.7 to -13.5 Vdc
+24 Vdc	18.1 to 20.9 Vdc



## Model 490.14/.17 Valve Driver Modules

PARAMETER	SPECIFICATION
<b>Valve Command Input:</b>	differential, voltage
<b>Max amplitude</b>	20 Vp-p
<b>Valve Drive Current Outputs:</b>	dual balance differential current source
<b>Max current</b>	25mA or 50 mA; selectable
<b>Max voltage</b>	±20V across 1 kΩ load
<b>Bandwidth</b>	> 45 kHz with 70 Ω to 1 kΩ loads
<b>Valve Balance:</b>	adjustable from + 1 Vdc to -1 Vdc
<b>Dither: Frequency</b>	0 - 50 kHz
<b>Amplitude</b>	0 - 20 Vp-p
<i>the following specify the inner loop circuit of the Model 490.17 Valve Driver</i>	
<b>Excitation:</b>	AC, 10 kHz, balanced
<b>Range</b>	constant voltage 10 Vp-p
<b>Load: Min impedance:</b>	100 Ω
<b>Load current</b>	150 mA max
<b>AC Amplifier:</b>	differential input, AC coupled, digital demodulation, DC output
<b>Overall gain</b>	x1 to x30 (cal factor)
<b>Input impedance</b>	75 kΩ
<b>Demodulator</b>	synchronous, digital
<b>Filter</b>	2.6 kHz Butterworth
<b>Output</b>	±10 Vdc
<b>Ripple</b>	40 mV p-p
<b>Phase adjust</b>	+90° to -90° in 1.41° steps
<b>Rate Stabilization:</b>	active differentiator
<b>Input</b>	spool position or dc error
<b>Reset Integrator:</b>	active integration of inner loop error
<b>Output</b>	clamped to < 7.5 V

## Model 490.21 DC Conditioner Module

PARAMETER	SPECIFICATION
<b>Excitation:</b>	
<b>Type</b>	balanced, constant voltage or constant current, supports 4 or 8 wire connection
<b>Range</b>	0V to 20V DC or 0 to 50 mA DC (other current ranges possible)
<b>Load current</b>	100 mA max
<b>Amplitude resolution</b>	12-bit (4.88 mV or 12.2 $\mu$ A)
<b>Accuracy of amplitude setting</b>	
<b>voltage mode</b>	$\pm 5$ mV $\pm 0.5\%$ reading
<b>current mode</b>	$\pm 0.05$ mA $\pm 0.5\%$ reading
<b>Amplitude stability</b>	
<b>voltage mode</b>	20 ppm/ $^{\circ}$ C (incls 3 ppm/ $^{\circ}$ C ref)
<b>current mode</b>	30 ppm/ $^{\circ}$ C (incls 3 ppm/ $^{\circ}$ C ref)
<b>Noise (10 to 500Hz)</b>	0.25 mVp-p
<b>Preamp:</b>	
<b>Type</b>	DC coupled
<b>Input impedance</b>	high impedance, differential
<b>current</b>	100 M $\Omega$ min 40 nA max
<b>Zero offset</b>	$\pm 50$ $\mu$ V RTI $\pm 0.7$ mV RTO max
<b>at gain=1</b>	$\pm 0.75$ mV RTO preamp max
<b>at gain=250</b>	$\pm 13.2$ mV RTO preamp max
<b>Zero stability</b>	$\pm 0.2$ $\mu$ V/ $^{\circ}$ C RTI $\pm 10$ $\mu$ V/ $^{\circ}$ C RTO
<b>Gain</b>	$\times 0.995 \pm 0.3\%$ ; $\times 250 \pm 0.5\%$
<b>Gain stability</b>	15 ppm/ $^{\circ}$ C max
<b>Common mode rejection</b>	
<b>0 <math>\Omega</math> balanced</b>	130 dB dc to 120 Hz , 114 dB at 1 KHz
<b>350 <math>\Omega</math> bridge, 1% unbalanced</b>	100 dB dc to 120 Hz
<b>Transducer Zero Adjustment:</b>	
<b>Type</b>	DAC on postamp input
<b>Range</b>	$\pm 20\%$ of calibrated transducer capacity
<b>Resolution</b>	16-bit 0.06 mV RTO postamp in range 1 (x1) 0.6 mV RTO postamp in range 4 (x10)

PARAMETER	SPECIFICATION
<b>Outputs:</b>	
<b>Conditioner out</b>	$\pm 10V$ full scale, $\pm 5$ mA max
<b>Conditioner monitor</b>	buffered conditioner out, $\pm 5$ mA max
<b>Conditioner Filter:</b>	
<b>Type</b>	3 pole low pass, dual freq, butterworth (standard)
<b>Calibration:</b>	
<b>Sensor cartridge</b>	<p>Plug in cartridge with room for 5 resistors to allow bipolar shunt cal for 5 calibrated ranges.</p> <p>Provides conditioner gage factor transfer and verification.</p> <p>Provides bridge balancing and completion for quarter and half arm bridges.</p> <p>Provides for 2 or 3 wire bridge completion.</p>
<b>Interlocks:</b>	
<b>Transducer excitation fail high trip point</b>	detects open or short on excitation supply 125 mA $\pm 10$ mA
<b>low trip point</b>	2.5 mA $\pm 0.5$ mA
<b>Conditioner saturation trip points</b>	<p>detects conditioner out of range or xdcr cable loss</p> <p><math>\pm 11V \pm 0.2V</math> (includes <math>\pm 0.1V</math> supply variance)</p>
<b>DC Conditioner: Postamp:</b>	
<b>Total transducer gain</b>	x1 to x64, x250 to x16,000 (standard)
<b>Gain stability</b>	20 ppm/ $^{\circ}C$
<b>Gain linearity</b>	
x500 (range 1)	0.01 %
x10000 (range 5)	0.05 %
<b>Bandwidth selection</b>	<p>-3 db at 500 Hz <math>\pm 10\%</math> (<math>\pm 0.25\%</math> at 50 Hz)</p> <p>-3 db at 50 Hz <math>\pm 10\%</math> (<math>\pm 0.25\%</math> at 5 Hz)</p>
<b>Zero stability</b>	$\pm 0.2 \mu V/^{\circ}C$ RTI $\pm 20 \mu V/^{\circ}C$ RTO
<b>short term zero stability</b>	$\pm 2$ mV at 1 minute at gain =x10000
<b>Noise</b>	measured from output to ground
<b>0.1 Hz to 10 Hz</b>	125 $\mu V$ p-p RTO max at x5000
<b>10 to 500 Hz</b>	15 mV p-p RTO max at x500
<b>Frequency response bandwidth (-3 dB at )</b>	12 KHz $\pm 10\%$
<b>phase lag at 1 kHz</b>	13 $^{\circ}$ max
<b>attenuation at 1 kHz</b>	-03 dB max

## Model 490.22 AC Conditioner Module

PARAMETER	SPECIFICATION
<b>Excitation:</b>	
<b>Type</b>	balanced, constant voltage or constant current
<b>Range</b>	0 to 20 Vp-p (7.07 Vrms) or 0 to 50 mA <sub>p-p</sub> (other current ranges possible)
<b>Load current</b>	200 mA p-p max
<b>Amplitude Resolution</b>	12-bit (4.88 mVp-p or 12.2 μA <sub>p-p</sub> )
<b>Accuracy of amplitude setting</b>	
<b>voltage mode</b>	±15 mV±0.5% reading
<b>current mode</b>	±0.1 mA±0.5% reading
<b>Amplitude Stability</b>	
<b>voltage mode</b>	30 ppm/°C (incls 15 ppm/C ref)
<b>current mode</b>	50 ppm/°C (incls 15 ppm/C ref)
<b>AC Amplifier:</b>	
<b>Type</b>	AC coupled
<b>Input impedance</b>	high impedance, differential 1 MΩ min/ 440 pf
<b>current</b>	5 nA max
<b>common mode rejection</b>	60 dB dc to 120 Hz
<b>0Ω, no unbalance</b>	50 dB at 10 KHz
<b>Cal factor (transducer sensitivity)</b>	mV p-p transducer output (at100%)/ Volts p-p excitation
<b>total cal factor range</b>	10 to 1000 mV/V
<b>Demodulator:</b>	
<b>Type</b>	synchronous, full wave
<b>Phase range</b>	digital generation
<b>resolution</b>	2.5 to 178° lag 0.7 deg (8 bit)
<b>Gain</b>	±0.3%
<b>Zero offset (at preamp output)</b>	±3 mV max at 500 mV/V cal factor
<b>Demodulator filter bandwidth</b>	5 pole Butterworth - 3dB at 3.8 kHz ± 10%
<b>Transducer Zero Adjustment:</b>	

PARAMETER	SPECIFICATION
<b>Range</b>	+100 0.5% to -100 0.5% +10V ±50 mV to -10V ±50 mV ±10V at zero readout
<b>Resolution</b>	16-bit 0.3 mV RTO postamp at range 1 (x1) 6.1 mV RTO postamp at range 5 (x20)
<b>Outputs:</b>	
<b>Conditioner Out</b>	±10V full scale, ±5 mA max
<b>Conditioner Monitor</b>	buffered conditioner out, ±5 mA max
<b>Conditioner Filter:</b>	
<b>Type</b>	3-pole, low-pass, dual freq. butterworth (standard).
<b>Bandwidth selection</b>	-3 db at 500 Hz ±10% (±0.25% at 50 Hz) -3 db at 50 Hz ±10% (±0.25% at 5 Hz)
<b>Interlocks:</b>	
<b>Transducer excitation fail high trip point</b>	detects open or short on excitation supply
<b>low trip point</b>	125 mA peak ±10 mA 2 mA peak ±1 mA
<b>Conditioner saturation trip points</b>	detects conditioner out of range or ± 11V ±0.4V
<b>AC Conditioner Module:</b>	
<b>Total transducer gain range</b>	0.5 to 3200 (standard).
<b>Total gain stability</b>	25 ppm/°C
<b>Total gain linearity</b>	±0.01% at 500 mV/V
<b>Total noise</b>	
<b>0.1 Hz to 10 Hz</b>	75 μVp-p RTO max at cal factor = 500 mV/V range 4 (x10)
<b>10 to 500 Hz</b>	10 mVp-p RTO max at cal factor = 500 mV/V range 4 (x10)
<b>Frequency response bandwidth (-3 dB at )</b>	with 500 mV/V LVDT and cond filter out, range 1 2.7 KHz ±10%
<b>phase lag at 1 kHz</b>	236 ° max
<b>attenuation at 1 kHz</b>	0.135 dB max

## Model 490.30 Workstation Communication Interface

---

<b>PARAMETER</b>	<b>SPECIFICATION</b>
<b>Module Size</b>	1/2 size IBM PC-AT board
<b>Off-board Communication</b>	RS-422 compatible differential signals
<b>DMA Channel (OS/2 only)</b>	Channel 1 or 3 (3 default)
<b>IRQ</b>	3 or 5 (5 default)
<b>Board I/O Address</b>	Base address can be located at 150, 200, or 300 hex
<b>Board I/O Address</b>	Base address can be located at 150, 200, or 300 hex

## Model 490.40 Analog I/O Module

PARAMETER	SPECIFICATION		
<b>Input Channels</b>	16 inputs total 6 sensor inputs (module locations 1 - 6) 8 software selected inputs for module locations 9 - 14 and/or J42 2 software selectable inputs (J77 and J78)		
<b>Input range</b>	22.5 Vp-p		
<b>Accuracy</b>	14-bit		
<b>Offset drift</b>	5 $\mu\text{V}/^\circ\text{C}$ max		
<b>Output Channels</b> <b>8 outputs standard</b>	<b>DAC</b>	<b>Destination</b>	<b>Type</b>
	DAC 1	Readout 1	Differential
	DAC 2	Readout 2	Differential
	DAC 3	Readout 3	Differential
	DAC 4	Readout 4	Differential
	DAC 5	Readout 5	Differential
	DAC 6	Readout 6	Differential
	DAC 7-8	To Valve Drivers	
	DAC 9 - 10*	To Valve Drivers	
	* Option for 3 and 4 control channels		
<b>Output range</b>	20 Vp-p		
<b>Resolution</b>	16-bit		
<b>Accuracy</b>	14-bit		
<b>Drift</b>	20 $\mu\text{V}/^\circ\text{C}$ max		
<b>10V DC Reference</b>			
<b>Initial accuracy</b>	$\pm 10.000\text{V} \pm 1 \text{ mV}$		
<b>Drift</b>	7 $\mu\text{V}/^\circ\text{C}$		
<b>10 kHz AC Reference</b>	10 Vp-p		
<b>Initial accuracy</b>	$\pm 12 \text{ mV}$		
<b>Drift</b>	10 $\mu\text{V}/^\circ\text{C}$		
<b>Dimensions</b>	233.35 x 220 mm		

## Model 490.50 Processor Module

---

PARAMETER	SPECIFICATION
<b>Digital Inputs:</b>	8 input channels
<b>Type</b>	optically isolated, constant sink
<b>Input</b>	12 mA nominal at 12 V,
<b>Range</b>	5 - 24 Vdc
<b>Digital Outputs:</b>	8 output channels
<b>Type</b>	optically isolated, latched
<b>Output characteristics</b>	30 mA sink at 5 V drop; (max) 3 mA sink at 0.3 V drop (max)



## Model 490.60 Hydraulic I/O Module

---

PARAMETER	SPECIFICATION
<b>Hydraulic Power Supply:</b>	
<b>contact rating</b>	4 A at 125 Vac or 30 Vdc max
<b>Hydraulic Service Manifold<sup>1</sup></b>	
<b>Solenoid</b>	4 A at 30 Vdc max
<b>Proportional (from low to high)</b>	20 to 700 mA; ramp rate 0 to 8.4 minutes
<b>HSM Auxiliary Outputs</b>	
<b>contact rating</b>	3 sets of NO/NC general purpose relays 0.5 A at 115 Vac, 0.5 A at 30Vdc
<b>Run Outputs</b>	
<b>contact rating</b>	2 sets of NO/NC run/stop relays 0.5 A at 30Vdc

<sup>1</sup> Maximum current for all HSM solenoids (total) is 3.8A.

## Appendix B

# Servovalve Adjustments

---

The servovalve adjustments optimize the interface between the digital controller and a specific type of servovalve. These adjustments are related to a Valve Driver plug-in module. The Drive selection in the Edit Control Channels window determines which adjustments are appropriate for the selected drive type (via the Adjust Drive window).

**Note** *Since you can assign names to input signals, control channels, and control modes, we refer to these items in a generic context. For example, you may have named a force input signal as "Load."*

---

## Prerequisite

You must define a control channel with the Edit Control Channel window before you can use a drive window. The Adjust Drive window that is displayed depends on the Drive Type selection in the Edit Control Channel window. You also need a Force Pod control mode and a Length SG control mode.

---

## Contents

[Initial Inner Loop Adjustments](#) 372

[Adjusting Valve Balance](#) 383

[Adjusting Dither Amplitude](#) 385

[Adjusting Inner Loop Gain and Rate](#) 387

---

## Hydraulic systems

Hydraulic systems use servovalves to control the actuator. The following complement of valves have different drive windows:

- ◆ **252 Valve**—represents the MTS Series 252 Servovalve.
  - ◆ **Dual 252 Valve**—represent 2 MTS Series 252 Servovalves mounted to the actuator manifold.
  - ◆ **256/257 Valve**— represent the MTS Series 256 and Series 257 Servovalves. Although these valves are different, they use the same adjustments. These servovalves have inner control loops.
-

## When to adjust

Use the following to determine when to perform each servovalve adjustment.

**Note** *During the system installation, perform all of the adjustments in this appendix.*

## Initial adjustments

When initially installing the system or a hydraulic component is replaced. These adjustments are only needed once and should not require readjustment. See **Making Initial Adjustments**.

## Valve balance

While running a test on a properly tuned system, you observe that the controlling sensor's peak and valley amplitudes are unequal. When you have completed a mechanical valve adjustment, always adjust the valve balance. See **Adjusting Valve Balance**.

## Dither

While running a test on a properly tuned system, you observe either of the following:

- ◆ A sinusoidal test waveform is distorted at its maximum and minimum points (peak and valley values change). This will normally be more observable during a test that has either a low-frequency or a low-amplitude test waveform. Dither amplitude is insufficient. See **Adjusting dither amplitude**.
- ◆ You hear a *really* annoying sound that irritates your nerves as much as a fingernail continuously scraping a blackboard or a poorly tuned radio whistle. Dither amplitude is excessive. See **Adjusting dither frequency**.

## Inner loop tuning

When initially installing the system or fine tuning the system. After tuning the inner and outer loops, you may choose to retune both loops to fine tune them. See **Adjusting Inner Loop Gain and Rate**.

---

## Initial Inner Loop Adjustments

---

The initial adjustments only need to be performed during system installation.

**Note** *Except for the Servovalve Polarity task, all of the initial adjustments are related to the inner loop of the 256/257 servovalves.*

### Abbreviated procedure

- Task 1 Set the Servovalve Polarity 373
    - 1. Getting things ready 373
    - 2. Select the polarity of the servovalve signal 373
    - 3. Check the movement of the actuator 374
    - 4. Reconnect the force sensor cable 374
  - Task 2 Getting Things Ready for Inner Loop Adjustments 375
    - 1. Get the hydraulic fluid up to temperature 375
    - 2. Turn off the reset integrators 375
    - 3. Define an analog output signal 376
  - Task 3 Adjust the Inner Loop Phase 377
  - Task 4 Zero the Spool Position Signal 378
  - Task 5 Adjust the AC Gain 379
  - Task 6 Select a Rate Amplifier Signal 381
  - Task 7 Adjust the Dither Frequency 382
-

## Task 1 Set the Servovalve Polarity

---

This task is common to all servovalves, it sets the polarity of the signal output from the valve driver to the servovalve. Use this setting in conjunction with the Transducer Polarity setting in the Sensor Calibration program to establish the preferred actuator movement to a positive or negative command. The polarity of the servovalve must be checked before sensor calibration begins.

---

### Step 1 Getting things ready

This step establishes the required conditions for the remaining steps.

- A** You need a force control mode for the Actuator Positioning Control. This can be identified as the Mode Label “Force A Pod” in the Edit Control Channel window.
  - B** If you do not have this type of a control mode, create it now.
  - C** Zero the Force sensor output. This can be done from the Adjust Input Signals window.
  - D** Ensure that the full extension of the actuator cannot contact anything. You may need to raise the load unit crosshead.
  - E** Select the force control mode as the Next APC Mode in the main TestStar window.
- 

### Step 2 Select the polarity of the servovalve signal

If you do not know what polarity to use for your servovalve, select normal.

- A** Open the Adjust Drive window from the Adjust menu.
  - B** Press the Setup pushbutton to display the polarity selections.
  - C** Select Normal polarity.
-

### Step 3 Check the movement of the actuator

Perform this step to verify that the actuator moves as you want.

- A** Press the Actuator Positioning Control switch on the load unit control panel to light the indicator. This enables the positioning control in force control.
- B** Press the HPS Control Low switch to apply low hydraulic pressure to the system.
- C** Press the HSM Control Low switch to apply low hydraulic pressure to the actuator.
- D** Adjust the Actuator Positioning Control clockwise.

**Note** *The following conditions assume you want a positive command to retract the actuator (i.e., tension = +.)*

- If the actuator retracts, the servovalve polarity is correct. Select **Normal** polarity.
  - If the actuator extends, the servovalve polarity must be reversed. Select **Inverted** polarity in the Adjust Drive window.
  - If the actuator is fully retracted, adjust the APC control clockwise. If the actuator extends, select **Inverted** polarity.
- E** Check the movement of the actuator. Adjust the Actuator Positioning Control counter-clockwise to extend the actuator, then adjust the APC clockwise to retract the actuator.
- 

### Step 4 Reconnect the force sensor cable

If you are adjusting a **252** or **dual 252** servovalve, you are done.

If you are adjusting a **256** or **257** servovalve, continue to task 2.

---

## Task 2 Getting Things Ready for Inner Loop Adjustments

---

Before performing any of inner loop adjustments, complete the following:

---

### Step 1 Get the hydraulic fluid up to temperature

Be sure that both the hydraulic fluid and the servovalve are at operating temperature. Remove any specimen and run the system in length control for at least 30 minutes using an 80% full-scale length command at about 0.1 Hz.

---

### Step 2 Turn off the reset integrators

- A** Turn off hydraulic pressure.
  - B** Open the Tuning window from the Adjust menu.
  - C** Drag the PIDF **I** control to zero, switch to another control mode to ensure that it is zeroed. This disables the reset integrator in the outer servo loop.
  - D** Return to your original control mode.
  - E** Open the Adjust Drive window (from the Adjust menu).
  - F** Press the Setup pushbutton and set the Inner Loop Integrator to Out. This disables the reset integrator in the inner servo loop.
-

### Step 3 Define an analog output signal

An analog output is needed to monitor various valve driver signals related to the inner loop.

- A Open the Edit Output Signals window from the Edit menu.
- B Set up the window as shown.

The Device name shown is a default name.

If you named your control channel, that name would precede Valve.

Such as Axial:Valve.

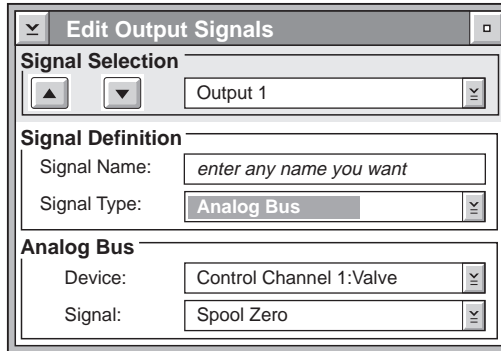

**Note** You will need to return to this window to change the signal selection. Each task will specify which signal to select.

- C Connect a meter to the rear panel connector J71 if you defined Output 1. Use J72 if you defined Output 2.

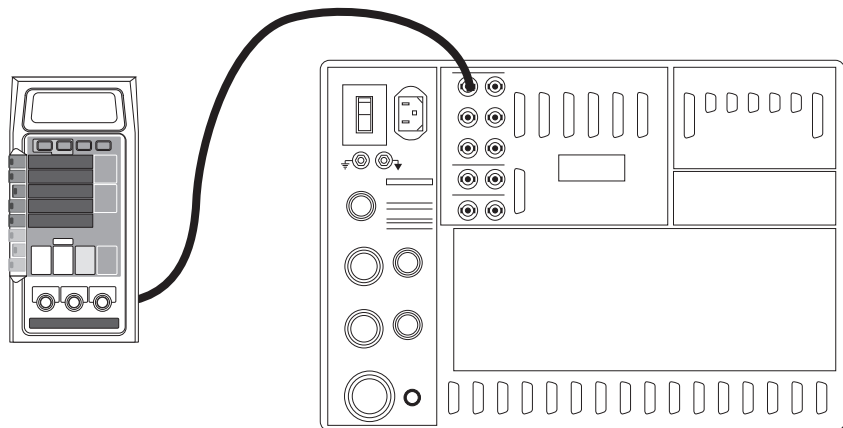



## Task 3 Adjust the Inner Loop Phase

---

The phase adjustment matches the phase of the inner loop LVDT feedback with the 10 kHz demodulator reference signal. This adjustment provides a maximum output for the maximum LVDT spool position offset.

**Note** *This adjustment must be set for the initial calibration, servovalve replacement, cable replacement, or valve driver replacement. Once the phase is correctly set, readjustment is not necessary during routine calibration.*

---

### Prerequisites

To perform this task the following must be true:

- ◆ The analog output signal is set for Spool Position.
  - ◆ A meter is connected to the rear panel Readout connector J71.
  - ◆ The Adjust Drive window is open.
  - ◆ The hydraulic fluid is at operating temperature.
- 

- A** Turn off hydraulic pressure
  - B** Disconnect J28 at the rear panel. This disables hydraulic pressure to the main stage of the servovalve while maintaining hydraulic pressure to the pilot valve.
  - C** Reverse the polarity of the valve output to move the LVDT spool to its maximum position when hydraulic pressure is applied. Check the Polarity setting in the Adjust Drive window and change it (from Normal to Inverted or vice versa).
  - D** Apply low hydraulic pressure. This moves the valve spool to its maximum position.
  - E** Adjust the Inner Loop Phase control to achieve the maximum spool position signal.
  - F** Remove hydraulic pressure and reconnect J28.
  - G** Return the polarity of the valve to its original setting (step A).
-

## Task 4 Zero the Spool Position Signal

---

This task matches the electronic null of the spool position signal with the mechanical null position of the servovalve pilot spool.

---

### Prerequisites

To perform this task the following must be true:

- ◆ The analog output signal is set for Spool Position.
  - ◆ A meter is connected to the rear panel Readout connector J71.
  - ◆ The Adjust Drive window is open.
- 

- A Set the Valve Balance control to zero.
  - B Set the Spool Zero control to zero.
  - C Apply hydraulic pressure.
- 

### **⚠ CAUTION**

**DO NOT remove the LVDT adjustment locknut or assembly when adjusting the servovalve LVDT spool position.**

If it is removed, hydraulic fluid will spray from the servovalve at full pressure. You should refer to the servovalve product manual to identify the main stage LVDT spool adjustment.

---

- D Loosen (but do not remove) the LVDT locknut.
  - E Adjust the LVDT in or out of the servovalve to provide a zero spool position signal.
  - F Tighten the locknut while holding the LVDT in position.
  - G Turn hydraulic pressure off.
-

## Task 5 Adjust the AC Gain

The AC gain adjustment calibrates the maximum valve spool feedback signal for 10 volts. This adjustment can affect tuning settings and the noise sensitivity of the valve command.

### Prerequisites

To perform this task the following must be true:

- ◆ The analog output signal is set for Spool Position.
- ◆ A meter is connected to the rear panel Readout connector J71.
- ◆ The Adjust Drive window is open.

- A** Turn off hydraulic pressure
- B** Disconnect J28 at the rear panel. This disables hydraulic pressure to the main stage of the servovalve while maintaining hydraulic pressure to the pilot valve.
- C** Set the AC Gain control to zero.
- D** Disconnect the servovalve connector (J11, J12, J13, or J14). This causes the spool of the main stage to reach its maximum position when hydraulic pressure is applied. Be sure the inner loop cable is connected (J111, J112, J113, or J114).

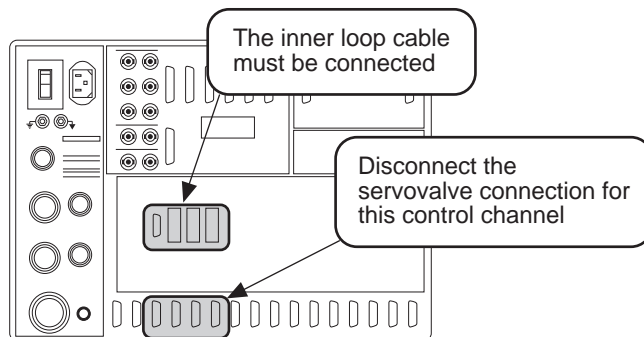

*Continued...*

**Task 5 (continued)**

- E** Reverse the polarity of the valve output to move the LVDT spool to its maximum position. Check the Polarity setting in the Adjust Drive window (Adjust menu) and change it (from Normal to Inverted or vice versa).
  - F** Apply hydraulic pressure. With J28 disconnected, there should be no hydraulic pressure to the actuator.
  - G** Adjust the AC Gain control for a 10 volt spool position signal. Some valve configurations will not go to 10 volts, in those cases, set the AC Gain to 7 volts. The polarity depends on the direction of the spool position.
  - H** Remove hydraulic pressure and reconnect J28.
  - I** Reconnect the servo valve connector (J11, J12, J13, or J14).
-

## Task 6 Select a Rate Amplifier Signal

---

- ◆ **Spool Position** is the sensor feedback from the servovalve. Most systems use spool position as the inner loop rate input.
- ◆ **Error** is the difference between the spool position and the command. This selection generally applies to custom systems.

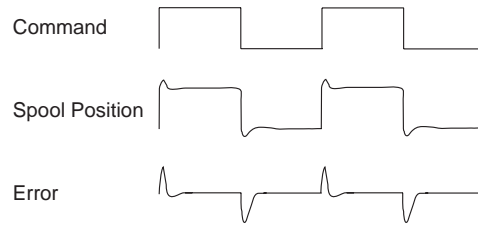

## Task 7 Adjust the Dither Frequency

---

Dither frequency is adjusted in conjunction with the dither amplitude. The following is an adjustment guideline (no specimen is needed):

- A** Set up the Function Generator for a very slow sine wave in length control.
  - B** Set up an oscilloscope to monitor the system response. Be sure you have an output channel defined.
  - C** Run the Function Generator.
    - If the system response indicates a smooth waveform, adjusting the dither frequency is not needed.
    - If the system response indicates a jagged waveform or if the dither amplitude can be detected, adjust the dither frequency.

**Note** *MTS Series 252 Servovalves are usually set at 500 - 700 Hz. MTS Series #256/257 Servovalves are usually set at 700 - 900 Hz. Avoid setting the dither frequency to a multiple of 5 kHz.*
  - D** Adjust the dither frequency until the system response becomes smooth.
    - If dither frequency is adjusted too low, the dither amplitude can be detected in the feedback signal.
    - If the dither frequency is adjusted too high, the effects of dither is negated (the system response indicates a jagged waveform).
-

## Adjusting Valve Balance

---

The valve balance adjustment electrically compensates for minor mechanical unbalance in the servovalve. This procedure is accomplished with no specimen installed.

**Note** For dual 252 servovalves; select separate balance controls if each valve is used for different tests, select combined balance controls if both valves are used for the same test.

---

### Step 1 Get the hydraulic fluid up to operating temperature

Be sure that both the hydraulic fluid and the servovalve are at operating temperature. Remove any specimen and run the system in length control for at least 30 minutes using an 80% full-scale length command at a velocity of about 0.1 - 0.75 Hz.

---

### Step 2 Turn off the reset integrators

This step disables the reset integrators in the inner and outer servo control loops.

- A** Turn off hydraulic pressure.
  - B** Open the Tuning window from the Adjust menu.
  - C** Drag the PIDF **I** control to zero. This disables the reset integrator in the outer loop.
  - D** Open the Adjust Drive window (from the Adjust menu).
  - E** Press the Setup pushbutton and set the Inner Loop Integrator to Out. This disables the reset integrator in the inner loop.
-

### Step 3 Adjust the valve balance

This step works through the TestStar windows needed to make the valve balance adjustment.

**Note** *If the electrical valve balance cannot be achieved, perform a mechanical adjustment. See the appropriate servovalve product manual for the mechanical valve balance procedure.*

*If a mechanical valve balance is performed, you must adjust the electrical valve balance.*

- A** Select a length control mode.
- B** Open the Adjust Input Signals window in the Adjust menu and select the force input signal.
- C** Be sure the Sensor Zero function is unlocked. Press the Auto Zero pushbutton to zero the output of the force input signal
- D** If you cannot zero the force signal, you may be using a force control mode—change control modes and try again.
- E** Monitor the force sensor output in the Adjust Input Signals window—it should be zero.
- F** Select a Force Pod control mode as the Next APC Mode in the main TestStar window.
- G** Enable the Actuator Positioning Control (**do not adjust the APC**).
  - If the actuator holds its position, valve balance is not needed.
  - If the actuator moves, adjust the valve balance.
- H** Adjust the Valve Balance control in the Adjust Drive window to stop the actuator movement.

Make the adjustment before the actuator reaches its maximum displacement; otherwise, you will need to reposition the actuator and continue the adjustment.

- I** Repeat this procedure to verify that the valve balance is properly adjusted.
-



## Adjusting Dither Amplitude

---

Dither is a small high frequency sine wave applied to the servo valve spool to keep it in motion so that it doesn't stick. This improves small-signal resolution.

---

### Step 1 Get the hydraulic fluid up to operating temperature

Be sure that both the hydraulic fluid and the servo valve are at operating temperature. Remove any specimen and run the system in length control for at least 30 minutes using an 80% full-scale command at a velocity of about 0.1 - 0.75 Hz.

---

### Step 2 Turn off the reset integrators

This step disables the reset integrators in the inner and outer servo control loops.

**Note** *Be sure you record the reset integrator settings so there may be returned to their original values after the dither amplitude is set.*

- A** Turn off hydraulic pressure.
  - B** Open the Tuning window from the Adjust menu.
  - C** Drag the PIDF **I** control to zero. This disables the reset integrator in the outer loop.
  - D** Open the Adjust Drive window (from the Adjust menu).
  - E** Press the Setup pushbutton and set the Inner Loop Integrator to Out. This disables the reset integrator in the inner loop.
-

### Step 3 Adjust the dither amplitude

To adjust dither amplitude, perform the following (no specimen is needed):

- A** Set up the Function Generator for a very slow ramp in length control.
  - B** Set up an oscilloscope to monitor the system response.
  - C** Run the Function Generator.
    - If the system response indicates a smooth ramp, adjusting the dither amplitude is unnecessary.
    - If the system response indicates a jagged ramp (the actuator sticks before moving) adjust the dither amplitude.
  - D** Increase the dither amplitude until the system response becomes smooth.
- 

### Step 4 Return the reset integrators to their original settings

Go back to step 2 and return the reset integrator settings to their original values.

---

## Adjusting Inner Loop Gain and Rate

---

The inner loop proportional gain and rate derivative adjustments are the same types of adjustments as used with the PIDF tuning controls.

**Note** *The inner loop gain and rate adjustments are usually performed before tuning the outer loop. The exception is if the outer loop is so sluggish that an initial gain adjustment may be needed.*

**CAUTION**

---

### Always tune the inner loop without hydraulics applied to the actuator

When performing inner loop gain adjustments, disable the main hydraulics to prevent interaction between the servovalve control loop and the main control loop.

---

#### Step 1 Turn off any compensation functions

This step disables the reset integrators in the inner and outer servo control loops. Be sure to disable any compensation functions that can affect the tuning adjustments. This includes:

- ◆ Amplitude Control in the Function Generator.
  - ◆ Reset integration in the TestStar Tuning window (outer loop) and Adjust Drive window (inner loop).
  - ◆ If your tuning program is generated by an optional TestWare application disable any compensation functions (i.e. SAC, PAC or FIT).
- A** Turn off hydraulic pressure.
  - B** Open the Tuning window from the Adjust menu.
  - C** Drag the PIDF **I** control to zero, this disables the reset integrator in the outer loop.
  - D** Open the Adjust Drive window (from the Adjust menu).
  - E** Press the Setup pushbutton and set the Inner Loop Integrator to Out. This disables the reset integrator in the inner loop.
-

## Step 2 Define an analog output signal

An analog output is needed to monitor various valve driver signals related to the inner loop.

- A Open the Edit Output Signals window from the Edit menu.
- B Set up the window as shown.

The Device name shown is a default name.

If you named your control channel, that name would precede Valve.

Such as Axial:Valve.

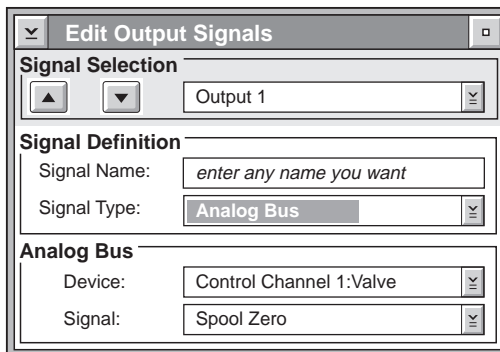

**Note** You will need to return to this window to change the signal selection. Each task will specify which signal to select.

- C Connect an oscilloscope to the rear panel connector J71 if you defined Output 1. Use J72 if you defined Output 2.

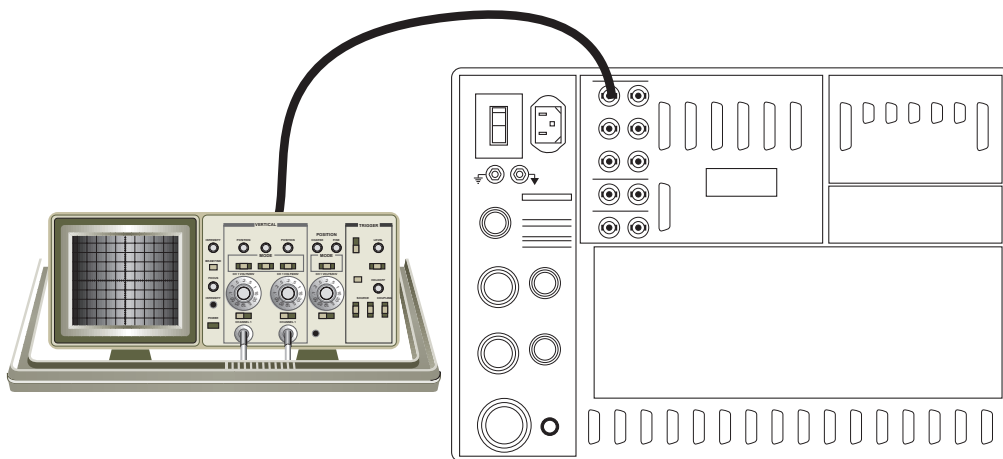

### Step 3 Disable hydraulic pressure to the main stage of the servovalve

Turn off hydraulic power and disconnect J28 at the rear panel of the digital controller. This disables hydraulic pressure to the main stage of the servovalve while maintaining hydraulic pressure to the pilot stage

### Step 4 Set up the function generator

You can modify this step to create a tuning program using TestWare-SX or any other TestWare application.

- ◆ Select a length control mode.
- ◆ Set up the function generator for as shown.
- ◆ The frequency should be slow enough that the valve can reach its programmed level. It should also be fast enough to easily view ringing on the waveform.

The function generator should be set up for:

a square wave  
10 Hz frequency  
length control  
10% full-scale amplitude

Be sure the Amplitude  
Mean Control is disabled.

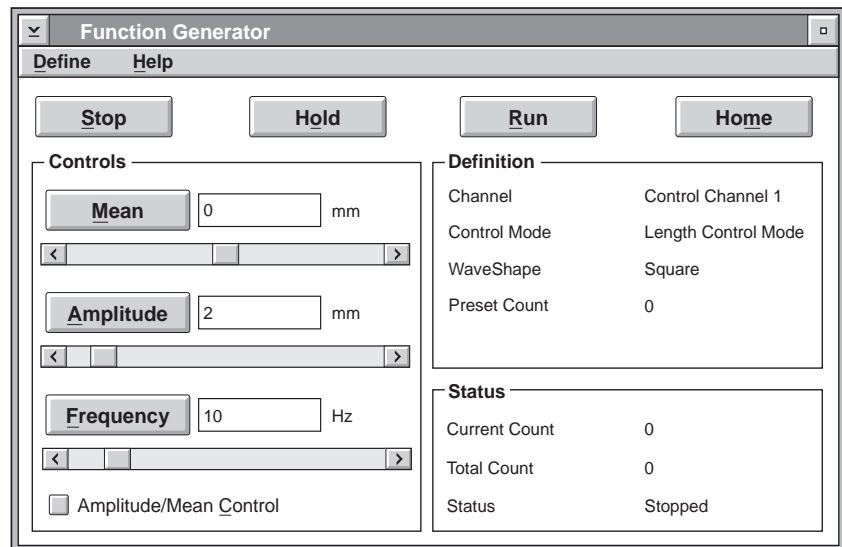

**Step 5 Adjust the inner loop gain and rate controls**

The inner loop gain and rate adjustments are similar to the gain and rate adjustment of the outer loop.

**Note** See Chapter 9 the Reference manual for additional tuning information.

- A** Start the function generator program.
- B** Adjust the inner loop gain and rate in a manner similar to the adjustment for P and D of the outer loop

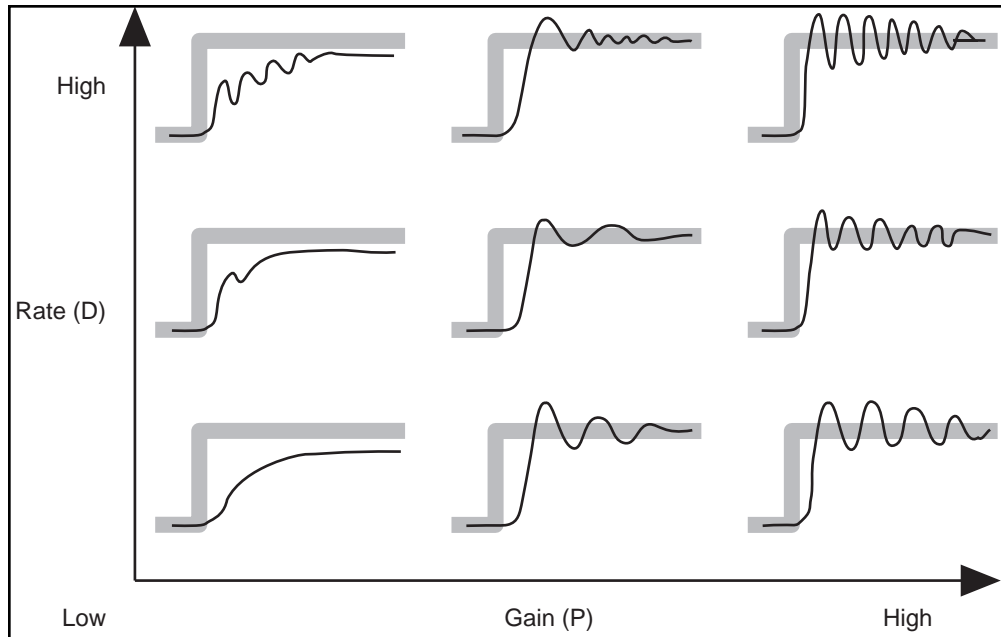

- C** When you have completed the adjustments turn off hydraulic pressure and reconnect J28.

## Appendix C

# System Calibration Program

---

The TestStar software includes a system calibration program to calibrate the digital controller. The digital controller is like any other test equipment and should be calibrated on an annual basis.

### CAUTION

---

**Calibrating the digital controller without the required equipment will invalidate test results.**

Be sure to calibrate the digital controller with the required equipment (or equivalent equipment meeting the required specifications).

---

## How it works

The system calibration program calibrates of the analog-to-digital (A/D) converters and the digital-to-analog (D/A) converters of the digital controller. This is accomplished by inputting a precision 10 volt reference and monitoring the output of each converter with a high precision voltmeter. Any difference between the reference voltage and a converter output becomes a calibration factor. The calibration factor for each converter is recorded in the SYSCAL.DB file located in the DB directory.

## Requirements

You must have the following equipment:

- ◆ a voltmeter with 150  $\mu$ V resolution (such as a Fluke 8505)
  - ◆ a 10 volt reference with 150  $\mu$ V resolution
  - ◆ a meter cable with a BNC connector
- 

## Prerequisites

If you have a multiple channel system and periodically change your hardware configuration for fewer channels, you must set your hardware configuration for the maximum number of channels in the system. Use the Setup program (see Chapter 2) to set the hardware configuration. The System Calibration program only calibrates the circuits related to the current hardware configuration.

---

## Procedure

When you begin the system calibration procedure, the digital controller should be turned on, hydraulics should be off, and the TestStar software should **NOT** be started.

1. Open an OS/2 window or a Windows NT command Prompt.
2. Backup the SYSCAL.DB. This file contains the current calibration factors for the Analog I/O module. The file is located in the DB directory of the TS2 directory. *For example;*

**COPY C:TS2\DB\SYSCAL.DB A:**

This copies the SYSCAL file to a floppy disk in the A drive. This is your backup of your current calibration data in the event something goes wrong (such as you are using a meter with inadequate resolution).

3. Connect a ground cable from the TestStar chassis (black lug) to the external ground on the meter.
4. Connect the voltmeter to the rear panel connector Calibrate Output J80.
5. Connect the 10 volt reference signal to the rear panel connector Calibrate Input J79.
6. Start the system calibration program by typing:

**TS2\SYSCAL** (for OS/2) or **Syscal** (for Windows NT)

The SYSCAL program initializes the digital controller. The program also prompts you throughout the procedure for information the program needs.

7. Adjust the Analog I/O module to  $10.0000 \pm 0.3$  mV (several iterations may be required). The adjustment is located under the yellow cal sticker.
8. At the prompt 'replace old values' – answer Yes
9. At the prompt 'do you want unattended input cal?' – answer Yes.
10. Answer No to the prompt "Do you want to skip the D/A cal?".

*Continued...*



**Follow the prompts**

11. The program automatically calibrates the analog-to-digital (A/D) converters.
12. The program prompts you to enter the voltmeter reading for each of the digital-to-analog (D/A) converters.
13. Copy the file SYSCAL.DB located in the DB directory of the TS2 directory to an archive directory or disk.
14. Run the checkcal program.

**Checkcal program**

The Checkcal program checks the analog-to-digital converters and digital-to-analog converters.

The acceptable variations are 1 mV for A/Ds and 2 mV for D/As. If an A/D or D/A is out of tolerance, run the system calibration program again.

Be sure to save the new syscal.db file on a backup disk and date it.

---

## Appendix D

# Diagnostics Program

**OS/2 ONLY**

This program is only available with version 3.1 of TestStar.

The TestStar software includes two diagnostic programs to check the load unit control panel and each plug-in module installed in the digital controller. The diagnostics program requires the TestStar Diagnostic Package (P/N 467635-01). The diagnostic package includes the jumper plugs and loop back cables needed by the diagnostic program.

Each test displays a message that describes which jumper plug or loop back cable is required for the test and how to connect it.

## Test procedure

Perform the following to run the diagnostics program.

1. Be sure the TestStar application is closed and electrical power to the digital controller is turned off.
2. Turn on power to the digital controller.
3. Double-click the MTS-TSII icon on the OS/2 desktop. Then double-click the Utilities folder. Double-click the Diagnostics icon.

You may need to log into the program. Enter your user name and password in the MTS Login window.

4. The program displays a message that suggests you have the diagnostics package near by. Press <ENTER> to continue.
5. The main menu displays the different tests you can run.

TEST	MODULE
1	Processor Board
2	Load Unit Control
3	Hydraulic I/O Board
4	Analog I/O Board
5	Instrumentation Bus Test
6	TestAll Boards
99	Exit Diagnostics

*Continued...*

### Test procedure (continued)

The menu allows you to select individual module tests or test all of the modules. Enter a number to select the test you wish to run.

For example, enter 6 to run all the tests. The following test descriptions are listed in the order they are run when item 6 is selected.

6. When the diagnostic tests are complete enter 99 to exit the diagnostic program.

### Processor test

The processor test checks the 490.50B Processor module. The loop back cable connects the digital outputs to the digital inputs. The test sends an output and checks the response of the input.

Connect the digital I/O loop back cable (p/n 467638-01) between the Digital Output (J55) and the Digital Input (J54) connectors on the TestStar rear panel. When the cable is in place, press enter to run the processor test.

When the test is complete, the program displays whether the test passed or failed.

### Load unit control test

The Load Unit Control (LUC) test allows you to observe the LUC functions and decide if the LUC is functioning properly. The test checks the LUC screen and the control switches.

The LUC screen test begins with “TestStar Diagnostics” shown on the screen. The computer screen displays what should be on the LUC screen. You should verify what is on the LUC screen and press <ENTER> on the computer to continue the test for each portion of the screen test. The LUC screen test checks the following:

- ◆ lights the screen
- ◆ darkens the screen
- ◆ blinks the screen

The LUC control switch test allows you to check any LUC control switch (except switches that are related to the Hydraulic I/O test). Press a control switch and the name of the switch is displayed on the LUC screen. Press <ENTER> to continue the test.

## Hydraulic I/O test

The hydraulic I/O test checks the response of the LUC switches related to hydraulic control and interlocks. The LUC should be located near the workstation computer for this test. Before the test can be run, the following rear panel connectors must be configured:

CONNECTOR	ACTION
<b>J23A, J23B Hyd Intlk</b>	Connect a jumper plug (p/n 397194-01) to each connector.
<b>J24 HSM Auxiliary</b>	Disconnect any cable from this connector
<b>J25 Hydraulic Power Supply</b>	Connect jumper plug p/n 397199-01
<b>J28 HSM Solenoid</b>	Disconnect any cable from this connector
<b>J43 Prgm Intlk</b>	Connect jumper plug p/n 397195-01.
<b>J44 Run Stop</b>	Disconnect any cable from this connector

When the proper rear panel connections are complete, type Y to proceed with the test. The hydraulic I/O test uses the computer screen to prompt you to press a specific LUC switch, then press <ENTER>. The test checks the following switches:

- ◆ Interlock Reset switch
- ◆ HPS Control switches
- ◆ HSM Control switches (for each control channel)
- ◆ Emergency Stop switch(es)

When the test is complete, the program displays whether the test passed or failed. At this point you should return all of the connectors to the configuration prior to this test.

## Analog I/O test

The analog I/O test checks the 490.40 Analog I/O module. This test checks the following:

- ◆ A/D converters
- ◆ D/A converters
- ◆ board noise

When the test is complete, the program displays whether the test passed or failed.

---

## Instrumentation bus test

The instrumentation bus test checks each ac conditioner, dc conditioner, and valve driver module plugged into the instrumentation bus. For each module the test displays the following information:

- ◆ slot number (module location)
- ◆ ID number (the setting of two hex switches on the circuit card)
- ◆ the type of plug-in module

Each conditioner must have the proper sensor connected. Each valve driver must have the servovalve disconnected and a jumper plug (p/n 397049-01) connected. Before each module test is run the program prompts you to check these conditions.

The program tests appropriate circuits for each type of module. Each circuit test shows whether the circuit passed or failed.

---

## WSCI Diagnostics

### OS/2 ONLY

This program is only available with version 3.1 of TestStar.

The workstation Communication Interface (WSCI) diagnostics consists of a cable from the TestStar Diagnostic Package and a diagnostics program. The WSCI diagnostics program checks the communications between the WSCI board in the computer and the digital controller. The program also checks for conflicts with the IRQ and DMA channels.

1. Open an OS/2 window or MSDOS window. Assuming your TS2 directory is located on the current drive, type the following to start the WSCI diagnostics program.
2. The program displays a list of options.
  - 1 - Diagnose WSCI Card and IRQ
  - 2 - Diagnose Workstation Cable?
  - 3 - Diagnose DMA
  - 4 - Diagnose Entire Communication Link

The #4 selection steps through the other three selections in order. Press 4 then <ENTER>.

### WSCI card and IRQ

3. The program begins by asking you to connect the loop back cable (p/n 467637-01).
4. The program sends information through the loop back cable. This fails if the IRQ assignment in the system configuration file (Config.SYS) doesn't match the IRQ channel jumper setting (X7) on the WSCI board. This test will also fail if another computer board is using the same IRQ assignment.

### Workstation cable

5. The program instructs you to remove the loop back cable and re-connect the Workstation cable (p/n 397034-01).
6. The program sends a signal to the digital controller which echoes the signal back through the WSCI board. It informs you if basic communication can be obtained with the digital controller.

### DMA

7. The program sends a signal to the digital controller which returns the signal through the DMA channel. This fails if the DMA assignment in the system configuration file (Config.SYS) doesn't match the DMA channel jumper setting (X5 & X6) on the WSCI board. This test will also fail if another computer board is using the same DMA assignment.

## Appendix E

# Load Unit Interface

This appendix shows three load unit crosshead lock configurations that cover most of the MTS load unit situations you may encounter.

- ◆ The 380.xx load unit has a special hardware package for its interface, see the Hardware Package section in Chapter 2 for 380 interface information.
- ◆ The 322.xx load units incorporated the same crosshead wiring as the 318 load unit in mid 1985. This is a very loose date and load units may have been built up to a year before or sometime after mid 1985.
- ◆ Some of the older load units are not equipped with crosshead solenoids and do not require cabling from the TestStar chassis. Unless they have an Emergency Stop switch, these units can be connected the same as the current load units.
- ◆ All cable diagrams (except the 397031-xx cable assembly) are listed in the Cable Handbook.

### 24 Vdc interface

This configuration shows TestStar connected to load units using 24 Vdc solenoids for the crosshead locks with a MS3102A-14S-5PX connector. This configuration requires the following:

- ◆ Cable assembly 370189-xx.

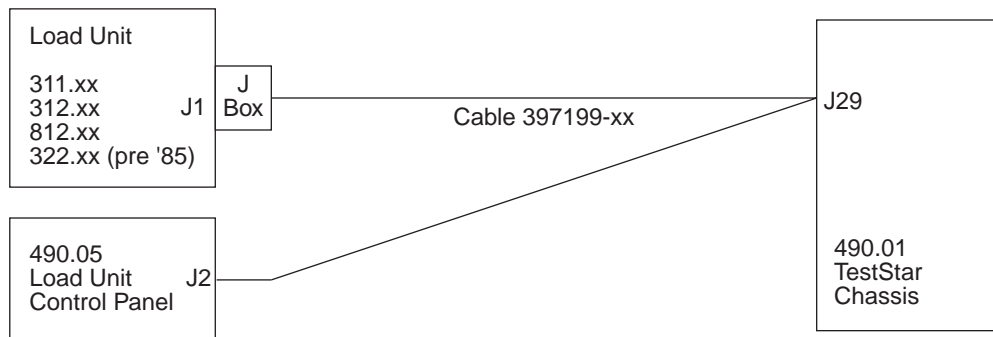

## 115 Vac interface

This configuration shows TestStar connected to load units using 115 Vac solenoids for the crosshead lock with a MS3102A-14S-5PX connector. This configuration requires the following:

- ◆ 115 Vac Solenoid Interface Package. This package allows systems to use existing 115 volt cabling that originally connected to a 436.11 or 413.05 Control Panel. See the Hardware Package section in Chapter 2 for more information about the 115 Vac Solenoid Interface package.
  - Part number 474390-01 if a 115 Vac outlet strip is available.
  - Part number 474390-02 if a 115 Vac outlet strip is not available (230 Vac systems with 115 Vac supplied from the HPS).
- ◆ Cable assembly 37189-01 (from the solenoid interface to the 490.05 load unit control panel).
- ◆ If the 474390-02 package is selected, cable assembly 397043-01 is required (115 Vac from the HPS).

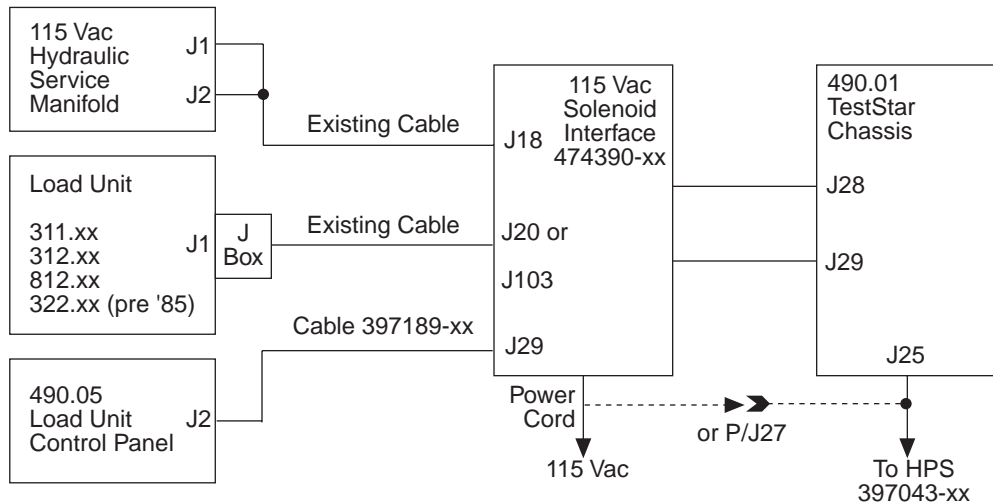



## No solenoid interface

This configuration shows TestStar connected to load units that use a pressure switch to detect the crosshead locks (with a CPC-9P connector). This configuration reflects the current load unit wiring philosophy. It requires the following:

- ◆ Cable 397186-xx if crosshead locks are present.
- ◆ Cable 397187-xx if crosshead locks are not present (E-Stop only)

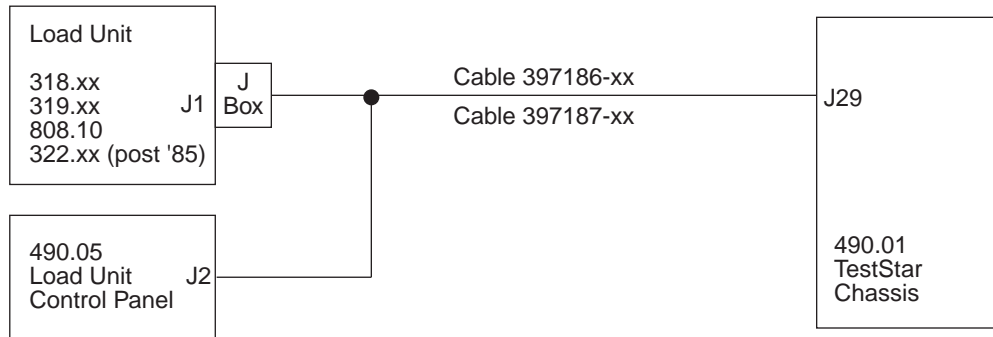

**Appendix F**

# Interlock Diagnostic Program

---

The interlock diagnostic program (ILKDIAG) checks the registers on the Hydraulic I/O module to establish the source of an interlock. This diagnostics program is provided for situations when you can't clear an interlock.

---

**Prerequisite**

TestStar must be running before you can use this program.

---

**Procedure**

Use this program after an interlock has occurred but before it is reset.

1. Open an OS/2 window or a MSDOS window (which ever is appropriate for your operating system).
2. Assuming your TSII directory is located on the current drive, type the following to start the interlock diagnostic program:

**TS2\ILKDIAG**

3. The window displays two menu selections:

**1-Perform Interlock Diagnostic**

**2-Display Status Registers**

Select one of the two selections (press 1 or 2 then enter).

- ◆ If you selected 1, proceed to Step 4.
- ◆ If you selected 2, proceed to Step 7.

**Interlock diagnostic**

4. The program displays a list of interlocks that correspond with the list on the load unit control panel.

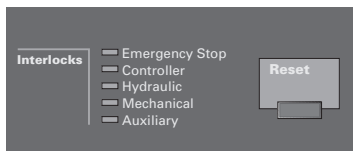

- 1 - Emergency Stop Indicator LED
- 2 - Controller Indicator LED
- 3 - Hydraulic Indicator LED
- 4 - Mechanical Indicator LED
- 5 - Auxiliary Indicator LED
- 6 - Other ((no LED on LUCP)
- 7 - Show all Indicated
- 99 - Exit

**Note** Remember to check Other since it doesn't have an indicator on the load unit control panel.

5. Select one of the seven selections. The program will display several possible causes for the active interlock. When done the program returns you to the main menu.
6. Press 99 to exit the program or select 2 and continue

**Status registers**

7. The program displays a list of registers. Select one of the four registers to display the current status of the register.

The following tables describe the status registers. The register signals identified with @ indicate a real-time signal and the following identifies the attributes used in the register table.

- c** control system pod Intlk LED
- e** emergency stop pod Intlk LED
- f** fault
- h** hydraulic pod Intlk LED
- j** read back of HI/O jumper setting
- l** lock
- m** mechanical pod Intlk LED
- o** overwrite with reset

STATUS REGISTER 0		
BIT	FUNCTION	ATTRIBUTES
D0	dump test	cfl
D1	emergency stop	efl
D2	24 Vdc fail	cfl
D3	mechanical intlk 0	mflo
D4	mechanical intlk 1	mflo
D5	crosshead intlk	pl
D6	HPS low level intlk	hflo
D7	HPS auxiliary intlk	hflo
D8	HPS high temp intlk	hflo
D9	program intlk 0	pl
D10	program intlk 1	pl
D11	'ddcfault'	cflo
D12	instrument fault	cflo
D13	'softfail'	cflo
D14	pump fail	hflo
D15	abort start	cflo

STATUS REGISTER 1		
BIT	FUNCTION	ATTRIBUTES
D0	'acfail'	cfl
D1	interbox intlk up	cflo
D2	interbox intlk down	cflo
D3	clock@	
D4	ups power	
D5		
D6	prop valve short	hflo
D7	watchdog	cfl
D8	error (HIO)	cf
D9	down error	cf
D10	power up reset	cfl
D11		
D12	up analyze	cfl
D13	'dumpsum'@	
D14	'locksum'@	
D15		

STATUS REGISTER 0		
BIT	FUNCTION	ATTRIBUTES
D0	dump test	cfl
D1	emergency stop	efl
D2	24 Vdc fail	cfl
D3	mechanical intlk 0	mflo
D4	mechanical intlk 1	mflo
D5	crosshead intlk	pl
D6	HPS low level intlk	hflo
D7	HPS auxiliary intlk	hflo
D8	HPS high temp intlk	hflo
D9	program intlk 0	pl
D10	program intlk 1	pl
D11	'ddcfault'	cflo
D12	instrument fault	cflo
D13	'softfail'	cflo
D14	pump fail	hflo
D15	abort start	cflo

STATUS REGISTER 1		
BIT	FUNCTION	ATTRIBUTES
D0	'acfail'	cfl
D1	interbox intlk up	cflo
D2	interbox intlk down	cflo
D3	clock@	
D4	ups power	
D5		
D6	prop valve short	hflo
D7	watchdog	cfl
D8	error (HIO)	cf
D9	down error	cf
D10	power up reset	cfl
D11		
D12	up analyze	cfl
D13	'dumpsum'@	
D14	'locksum'@	
D15		

**Appendix G**

# Strain Gage Calibration

---

Strain gages usually need quarter and half bridge completion resistors. The sensor cartridge provides locations for the bridge completion resistors. Two and three wire bridge completion and bridge balancing are supported.

**Prerequisite**

- ◆ Older DC conditioners and sensor cartridges cannot perform bridge completion.
  - ◆ You must have a DC conditioner at revision level E (or higher). The revision level is identified with a sticker on the DC conditioner module.
  - ◆ You must have a sensor cartridge at revision level C (or higher). You must open the cartridge to determine the revision level. Revision C includes a bridge balancing adjustment (R10) and jumper X1.
- 

**What you need to know**

You need the following information about the strain gage you intend to use:

- ◆ gage resistance
  - ◆  $\mu$ strain
  - ◆ gage factor
  - ◆ number of active gages
-

## How Bridge Completion Works

Strain gages are sometimes bonded directly to a specimen to measure its deformation under stress. The gages are connected in a Wheatstone bridge configuration. One or more arms are bonded to the specimen with the remaining arms installed in a bridge completion circuit.

The sensor cartridge contains the bridge completion circuit.

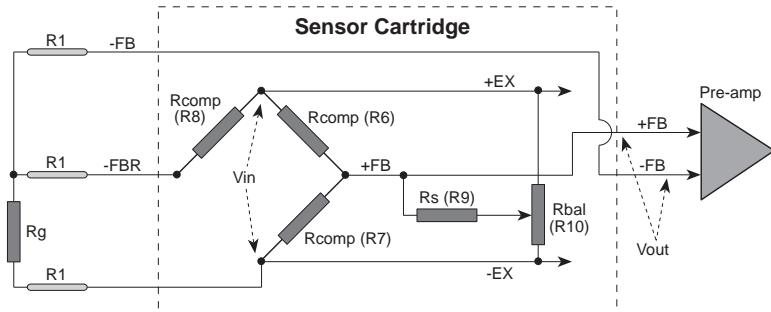

A three-wire bridge completion scheme is the recommended configuration. This configuration incorporates the resistance of the cable wires into the bridge to minimize errors. It is unlikely that you can obtain resistors that are completely matched in a bridge completion circuit. This results in an offset in the output of the bridge. The bridge balance adjustment (R10) is provided to remove this offset.

Resistor R9 can be changed to bias the bridge balance adjustment (R10) for different bridge resistor values. For 350  $\Omega$  bridges, use a 24.9 k $\Omega$  resistor as R9. For 120  $\Omega$  bridges, use a 2.21 k $\Omega$  resistor as R9. Jumper X1 selects two or three wire bridge completion.

- ◆ Two wire bridge completion is not recommended since the usable length of a sensor cable is too short to be practical.
- ◆ Three wire bridge completion (jumper pins 1 and 2) is suitable for all bridge completion purposes.

### ⚠ WARNING

**Two-wire bridge completion can cause your system to go hard over when hydraulic pressure is applied. This is caused by resistance in the sensor cable.**

The cable resistance unbalances the Wheatstone bridge circuit to the point where it cannot be balanced with the sensor cartridge adjustment. We recommend that you always use the three-wire bridge completion configuration.

## Strain Gage Calibration Procedure

---

The following procedure gives a general outline for calibrating a strain gage at  $-80\%$ ,  $0\%$ , and  $+80\%$  of full scale. It does not specify further details and standards that might be used. Some of the following considerations might improve the accuracy of the calibration:

- ◆ Environment—try to calibrate the gage where it will be used, and at typical temperature and atmospheric conditions.
- ◆ Linearity—to verify linearity, check the calibration at more points ( $-100\%$ ,  $-80\%$ ,  $-60\%$ ,  $-40\%$ ,  $-20\%$ ,  $0\%$ ,  $20\%$ ,  $40\%$ ,  $60\%$ ,  $80\%$ ,  $100\%$ )
- ◆ Repeatability—to check repeatability, run the calibration twice.

This procedure is for a single-element strain gage arranged as shown in the figure earlier in this chapter. This procedure will automatically compensate for the wire resistances of the cable between the conditioner and strain gage.

1. Determine the gage factor ( $GF$ ) and nominal gage resistance ( $R_0$ ) for the strain gage from the manufacturer's data sheets. The resistance of the gage ( $R_s$ ) is a function of the strain ( $\epsilon$ ) on the gage and is governed by the equation:

$$\begin{aligned} R_s &= (1 + GF \times \epsilon) \\ &= R_0 + \Delta R \end{aligned}$$

2. Determine the full scale strain ( $\epsilon_{FS}$ ) for the calibration setup.
3. Compute the change in gage resistance ( $\Delta R$ ) at full scale strain ( $\epsilon_{FS}$ ):

$$\Delta R = R_0 \times GF \times \epsilon_{FS}$$

*For Example:*  $R_0 = 350\Omega$

$$GF = 2$$

$$\epsilon_{FS} = 5000 \mu\epsilon$$

$$\Delta R = 350 \times 2 \times (5000 \times 10^{-6})$$

$$\Delta R = 3.5\Omega$$

4. Neglecting wire resistance, the output from the quarter bridge circuit is governed by:

$$V_0 = \left( \frac{\Delta R}{2R_0 + \Delta R} \right) \times \frac{V_{EX}}{2}$$

Compute the gain needed to amplify the bridge output so that the conditioner output is -8.0 V at -80% of full scale strain:

$$G = \frac{-8.0}{V_0(-80\%)}$$

*For Example:*  $R_0 = 350\Omega$   
 $\Delta R_{-80\%} = -2.8\Omega(-0.8 \times \Delta R)$   
 $V_{EX} = 10.0V$   
 $G = \frac{-8.0}{\frac{-2.8}{2(350) + (-2.8)} \times 10/2}$   
 $G = 398.4 \text{ V/V}$

5. Compute the shunt cal resistance ( $R_{SH}$ ) that would produce the same output as computed in step 4:

$$R_{SH} = -R_0 \left( \frac{\Delta R + R_0}{\Delta R} \right)$$

*For Example:*  $R_0 = 350\Omega$   
 $\Delta R_{-80\%} = -2.8\Omega$   
 $R_{SH} = -350 \times \frac{-2.8 + 350}{-2.8}$   
 $R_{SH} = 43.4 \text{ K}\Omega$



6. Select a shunt cal resistor with a standard value close to the  $R_{SH}$  computed in Step 5. Compute the equivalent strain:

$$\epsilon_{SH} = \frac{\Delta R_{SH}}{GF \times R_0}$$

*For Example:*  $GF = 2$   
 $R_0 = 350\Omega$   
 $R_{SH} = 43.2 \text{ K}\Omega$  (standard 1% resistor value)  
 $\epsilon_{SH} = \frac{1}{2} \left( \frac{350}{350 + 43200} \right)$   
 $\epsilon_{SH} = 4018.4\mu\epsilon$

7. Initially set the conditioner gain and excitation values to those used in Step 4, and the zero to zero. When setting the excitation, make sure not to exceed the voltage ratings of the strain gage or completion resistors. With the gage unstrained and unshunted, check the initial zero. Extremely large offsets may be an indication of a bad gage or one that has been improperly pasted to the specimen. Zero the conditioner output using the conditioner zero.

initial gain = 398.4 V/V  
 initial zero = 0.0 V  
 initial excitation = 10.0 V (usually smaller for 120  $\Omega$  gages)

Due to the nominal gage resistance tolerance (typically 1%) offsets as large as 100% could be possible.

8. Set the  $\Delta K$  (Delta K) gain by the following equation to compensate for nonlinearities in the single element bridge:

$$\Delta K = \left[ 1 + \left( \frac{GF}{2} \right) \epsilon_{+80\%} \right]$$

*For Example:*  $GF = 2$   
 $\epsilon_{+80\%} = 4000\mu\epsilon$   
 $\Delta K = \left[ 1 + \left( \frac{2GF}{2} \right) 4000 \times 10^{-6} \right]$   
 $\Delta K = 1.008$

9. In the Shunt Calibration feature of the Adjust Input Signals window, enable the positive (+) shunt, then press and hold the Shunt Cal button. Adjust DC Conditioner Gain until the conditioner output is equal to the output computed below. Although the gain (G) computed in Step 4 will be close to the necessary value, any wire resistance will desensitize the strain gage. For this reason, Gain must be increased slightly to compensate.

$$V_{out} = 10 \left( \frac{\epsilon_{SH}}{\epsilon_{FS}} \right) (\Delta K)$$

*For Example:*  $\epsilon_{SH} = 4018.4 \mu s$

$$\epsilon_{FS} = 5000 \mu s$$

$$\Delta K = 1.008$$

$$V_{out} = 10 \left( \frac{4018.4}{5000} \right) (1.008)$$

$$V_{out} = 8.101 \text{ V}$$

---

## Strain Gage Reference Information

The following table and figure show data for the “ideal” output from the strain gage conditioner setup with the above procedure. Actual accuracies will depend on factors not considered here such as the accuracy of the gage factor (GF).

<b>STRAIN (<math>\mu</math>E)</b>	<b>R<sub>G</sub> (<math>\Omega</math>)</b>	<b>V<sub>OUT</sub> (DESIRE D)</b>	<b>V<sub>OUT</sub> W/<math>\Delta</math>K</b>	<b>ERROR (%)</b>
-5000	346.50	-10.00	-10.010	-0.10
-4500	346.85	-9.00	-9.005	-0.05
-4000	347.20	-8.00	-8.000	0.00
-3500	347.55	-7.00	-6.997	0.03
-3000	347.90	-6.00	-5.994	0.06
-2500	348.25	-5.00	-4.993	0.08
-2000	348.60	-4.00	-3.992	0.08
-1500	348.95	-3.00	-2.993	0.07
-1000	349.30	-2.00	-1.994	0.06
-500	349.65	-1.00	-0.996	0.04
0	350.00	0.00	0.000	0.00
500	350.35	1.00	1.003	0.03
1000	350.70	2.00	2.006	0.06
1500	351.05	3.00	3.007	0.07
2000	351.40	4.00	4.008	0.08
2500	351.75	5.00	5.007	0.07
3000	352.10	6.00	6.006	0.06
3500	352.45	7.00	7.003	0.03
4000	352.80	8.00	8.000	0.00
4500	353.15	9.00	8.995	-0.05
5000	353.50	10.00	9.990	-0.10

## Calculate shunt resistance

Calculate the shunt calibration resistor.

$$R_s = \left( \frac{R_g \times 10^6}{A^n \times \epsilon_s \times K} \right) - R_g$$

$R_g$  = gage resistance

$A$  = number of active gages

$\epsilon_s$  =  $\mu$ strain

$K$  = Gage factor

$R_s$  = shunt resistance

## Setting up the sensor cartridge

Before you can install the bridge completion resistors, you must know the resistance of the strain gage that is attached to the specimen. Each resistor of the Wheatstone bridge should be the same value.

1. Be sure jumper X1 is set across pins 1 and 2.
2. Measure the resistance of the strain gage attached to the specimen.
3. Install the bridge completion resistors of the same resistance in the sensor cartridge. Use bridge completion resistors specified as RN55E (25 ppm/C° or less).

Install bridge completion resistors R6 and R7 for half bridge circuits and add R8 for quarter bridge circuits.

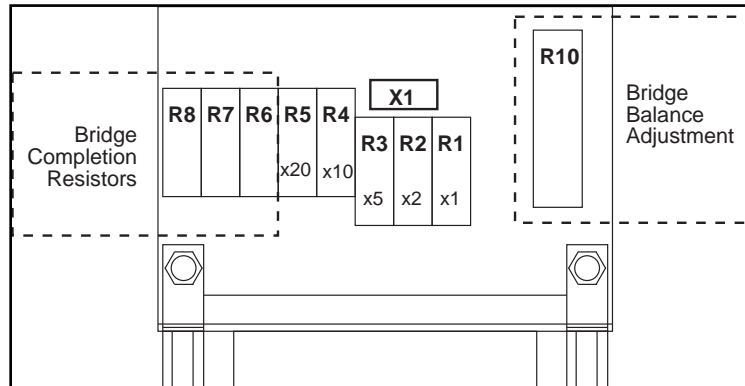

4. Monitor the input channel (in the Sensors window) and adjust R10 to null the output.

## Bridge completion configurations

The sensor cartridge provides a bridge completion resistor network (resistors R6, R7, and R8) to allow you to use quarter and half bridge configurations. The completion resistor values are dependent on the strain gage and must be calculated according to the application. Transducer types that can be accommodated by the conditioner include:

- ◆ quarter bridge (three-wire configuration)
- ◆ half bridge (three-wire configuration)

### Quarter bridge (3-wire)

For the quarter bridge configuration you have one strain gage installed on the specimen. The strain gage has a resistance rating; bridge completion resistors R6, R7, and R8 should have the same resistance as the strain gage. Install all three bridge completion resistors (R6, R7, and R8) in the positions made in the sensor cartridge. (See page 412).

### Half bridge (3-wire)

For the half bridge configuration you have two strain gages installed on the specimen. Each strain gage has the same resistance rating; bridge completion resistors R6 and R7 should have the same resistance as the strain gages. Install two bridge completion resistors (R6 and R7) in the positions made in the sensor cartridge. (See page 412).



# Index

---

## Symbols

---

±15 Volt Power Package 95

## Numerics

---

115 Vac Solenoid Interface 100

## A

---

AC conditioner  
  jumpers 50  
  module location 48  
  specifications 364  
AC gain 379  
Acceleration compensation 177, 195  
ADT interface 98  
ADT Support Package 98  
Analog bus  
  defining 230, 263, 294  
Analog inputs 104  
Avoiding hazardous actuator movement 18

## B

---

Before you call 28  
Bridge completion  
  how it works 406  
  resistor locations 412  
  shunt cal calculation 412  
Bridge configuration  
  half bridge 413  
  quarter bridge 413

## C

---

Cables  
  jumper plugs 119  
  rear panel connectors  
    J111-J114 Auxiliary I/O 150  
    J11-J14 Sensor/Servo Valve Connections 146  
    J1-J10 Sensor Connections 144  
    J20 HSM Proportional 121  
    J23 Hyd Intlk 135  
    J24 HSM Auxiliary 122  
    J25 Hydraulic Power Supply 123  
    J28 HSM Solenoid 124  
    J29 Load Unit 125  
    J30 Emergency Stop 126  
    J41 Readout 128  
    J42 External Data Inputs 129  
    J43 Prgm Intlk 136, 137  
    J50 Load Unit Link 130  
    J51 Workstation Link 131  
    J54 Digital Input 138  
    J55 Digital Output 140  
    J61 Aux I/O 142  
    J63/J64 Extended Analog I/O 132  
    J71-J80 BNC Connectors 133  
Cabling  
  CE compliant 117  
Calibration  
  backing up data 327  
  data base overview 321  
  digital controller 391  
  DVM connection 231, 263, 295  
  equipment 225, 289  
  exporting data 327  
  extensometer 289  
    calibrating additional ranges 315  
    calibrating compression 307  
    calibrating tension 309  
    calibrating zero 306  
    calibration equipment 289  
    conditioner information 304  
    creating sensor data base 298  
    data base record 290  
    defining calibration equipment 302

- getting things ready 293
- ranges 313
- recording data points in 8-
  - Data base
  - template 313
- saving sensor data base 301
- shunt cal 311
- using templates 313
- using templatesCalibration
  - extensometer
    - ranges 315
- external
  - command 338
  - sensor 338
  - signals 346
- force 257
  - calibrating additional ranges 284
  - calibrating compression 276
  - calibrating tension 278
  - calibrating zero 275
  - calibration equipment Calibration
    - equipment 257
  - conditioner information 273
  - creating sensor data base 267
  - data base record 258
  - defining calibration equipment 271
  - getting things ready 261
  - load standard mounting 265
  - ranges 282, 284
  - recording data points
    - Data base
    - template 282
  - saving sensor data base 270
  - shunt cal 280
  - using templates 282, 284
- importing data 331
- LVDT 225, 226
  - calibrating additional ranges 251
  - calibrating extension 245
  - calibrating retraction 247
  - calibrating zero 244
  - calibration equipment 225, 239
  - conditioner information 241
  - creating sensor data base 235
  - getting things ready 229
  - ranges 251
  - recording data point 249
  - saving sensor data base 238
  - saving sensor data base in 6-Sensor
    - data base
      - saving in 6- 238
  - using template 251
  - outputting data 323
  - printing data 323
  - retrieving data 331
  - strain gage 407
  - strain gages 405
  - system 391
    - temporary signals 352
- Caution symbol 26
- CE compliance 173, 192
- CE compliant cabling 117
- Changing sensors
  - sensor connectors 144
- Compression
  - extensometer calibration 309
  - force calibration 278
  - LVDT calibration 247
- Contacting MTS 27
- Control Channels
  - control modes 210
  - defining 209
- Control channels
  - maximum number of 172, 191
- Control Modes
  - defining 210
  - defining CLC 212
  - defining PIDF 211
- Creating usernames 216
- Crush point hazards 17

## D

---

- Data base 226, 258, 321
  - creating 235, 267, 298
  - opening 267, 298
  - opening
    - 235
  - printing sensor files 323
  - saving 238, 270, 301
  - saving in 6- 238
  - template 251, 284
- Data Base Record
  - template 315
- Data base record
  - definition 290
- data base record 226
- DC conditioner
  - module location 48
  - specifications 362
- Defaults
  - configuration file 218



- password 205
- user name 205
- Diagnostic program 394, 398
- Diagnostic programs 402
- Digital controller
  - calibration program 391
  - console 43
  - floor-standing 42
  - grounding 44
  - module installation 46
- Display
  - defining the LUCP 219
- Dither
  - adjusting amplitude 385
  - adjusting frequency 382

## E

---

- Electrical power 45
- Electro-mechanical systems 190
- Electro-mechanical systems in 4- 171
- E-mail 27
- Excitation drive 55, 56
- Exporting sensor data 327
- Extended Analog I/O 104
- Extended I/O 170
- Extensometer
  - calibrating zero 306
  - calibration 289
  - connecting 295
  - Series 633 interface 95
- External command source 337
  - abbreviated procedure 341
  - characteristics 355
  - connecting 344
  - equipment 342
  - permanent definition procedure 346
- External sensor 337
  - abbreviated procedure 341
  - characteristics 354
  - connecting 344
  - definition 350
  - equipment 343
  - permanent definition procedure 346
- External signal
  - defining Sensor
    - external
      - temporary calibration 350
- External signals
  - ab-breviated procedure 341

- characteristics 354
- command source 337, 342
- connecting 344
- feedback 343
- sensor 337

## F

---

- Fax number 27
- Feedback
  - safety precaution 18
- Filter options 52, 57
- Force
  - calibrating zero 275
  - calibration 257
- Force sensor
  - connecting 263
- Forward Loop Filter Package 92

## G

---

- General safety guidelines 13
- Grounding 44

## H

---

- Half bridge 413
- Hardware definition 170, 188, 190
- Hardware installation 41
- Hardware packages 79
  - 115V solenoids 100
  - 15 volt power 95
  - 448.16 power driver 87
  - ADT support 98
  - extended analog I/O 104
  - forward loop filter 92
  - inner loop 84
  - Load Unit Interface 81
  - multiple HSM channels 88
  - production QC 106
- Hardware specifications 359
- Hazard conventions 26
- Help 27
- HELPLine 28
- High speed data acquisition 171, 190
- How to

- contact MTS 27
- troubleshoot 28
- Hydraulic
  - 115V solenoid interface 100
  - multiple channel kit 88
- Hydraulic power supply
  - configuration 172, 190
- Hydraulic service manifold
  - configuration 174, 192

## I

---

- Importing sensor data 331
- Initial Software Settings 201
- Input Signals
  - defining 206
- Input signals
  - defining external input 351
- Installation
  - additional applications 178
  - COMTEST.EXE 179, 197
  - digital controller 42
  - grounding 44
  - initial software settings 201
  - overall procedure 33
  - plug-in modules 46
  - software 155, 156
- Instrumentation bus 49
- Interlock
  - diagnostic program 402
- Internet address 27
- Interrupt level 72
- Interrupt Request Setting
  - Interrupt source 72
- Interrupt source 72
- Interrupt source level selection 72
- IRQ
  - Interrupt source 72
- IRQ (Interrupt Request 72

## J

---

- Jumpers
  - ac conditioner 50
  - clock, phase, ac reference 51
  - excitation drive 50
  - external program select 53
  - filter options 52

- optional readout 51
- transducer zero 50
- dc conditioner 54
  - 4/8 wire sensor 54
  - excitation drive 55
  - excitation feedback 55
  - external program 58
  - filter option 57
  - guard drive 55
  - transducer zero 56
- hydraulic I/O 62
  - crosshead interlock 62
  - hyd interlock configuration 63
  - load unit configuration 63
  - watchdog enable 62
- instrumentation bus controller 65
  - bootstrap source 65
  - link speed 65
- link speed 66
- processor 64
  - digital input connector 139
  - digital input signal 64
  - system control source 64
- valve driver 59
  - forward loop 61
  - reset integrator 61
  - valve clamp 59
  - valve setup 60
- WSCI
  - board address 71
  - DMA channel assignment 72
  - interrupt source 72
  - link speed 71

## L

---

- Load standard 265
- Load unit
  - 115 Vac 100, 400
  - 24 Vdc 399
  - 380 interface kit 81
  - no solenoids 401
- Load unit control panel
  - defining the display in 219
- Logging 204
- LVDT
  - calibrating zero 244
  - calibration 225
  - connecting 231
  - connector 145

## M

---

Machine control modules 49  
 Maintenance 24  
 Manual  
   how to use 9  
   other manuals 11  
 Model 380 Load Unit Interface Package 81  
 Model 448.16C Power Driver Package 87  
 Model 490.17 Valve Driver Package 84  
 Modifications 22, 79  
 Modules  
   diagnostic program 394  
   Hyd Intlk program 402  
   installation 47  
   instrumentation bus 49  
   jumpers 47  
     ac conditioner 50  
     dc conditioner 54  
     hydraulic I/O 62  
     instrumentation bus controller 65  
     link speed 66  
     processor 64  
     valve driver 59  
   model numbers 47  
   specifications 359  
 MTS technical assistance 27  
 Multiple channels  
   HSMs 88  
 Multiple HSM Channels 88

## N

---

New languages 169, 187

## O

---

Obtaining technical assistance 27  
 Output signal  
   defining analog bus 230, 263, 294  
 Output signals  
   defining 213  
 Outputting sensor data 323

## P

---

Password  
   defining 217  
 Perform 215  
 Plug-in modules (see modules) 46  
 Polarity  
   servovalve 373  
 Power 45  
 Power supply specifications 360  
 Printing  
   calibration files 326  
 Production QC 106  
 Program  
   Basic programming calls 163  
   C programming calls 163

## Q

---

Quarter bridge 413

## R

---

Range  
   creating new ranges 253, 286

## S

---

Safety  
   guidelines while operating equipmen 16  
   precautions 12  
 Select 232  
 Sensor  
   angular displacement kit 98  
   calibrating zero (force) 275  
   calibrating zero (LVDT)  
     244  
   calibrating zero (strain) 306  
   cartridge  
     closing 76  
     opening 75  
     resistor  
       location 78  
     shunt cal resistors 77  
   data base

- creating 235, 298
  - opening 235, 267, 298
  - saving 238, 270, 301
- exporting cal data Data base
  - backup sensor file 327
- external
  - defining 337
  - permanent calibration 346
- external sensor
  - rcord 328
- importing cal data Data base
  - importing sensor file 331
- internal sensor record 328
- printing cal data 323
- Sensor Calibration Data 321
- Sensor data base
  - creating 267
- Sensors
  - defining input signals 206
  - defining output signals 213
- Servo valve
  - adjustment procedure 383
  - adjustments 370
  - checking polarity 36
  - initial adjustments 372
  - inner loop gain 387
  - inner loop rate 387
  - Series 256/257
    - inner loop gain and rate adjustment 387
    - power driver kit 87
- Servo valves
  - AC gain 379
  - inner loop phase 377
  - polarity 373
  - spool position 378
- Shunt Calibration
  - for extensometer 311
  - standard resistor values 77
- Shunt calibration
  - for force 280
  - resistor locations 78
- Software
  - initial settings 201
- Special Hardware Packages 79
- Specifications 359
  - ac conditioner 364
  - analog I/O 367
  - dc conditioner 362
  - hydraulic I/O 369
  - power supply 360
  - processor 368
  - valve driver 361
  - WSCI 366

- Specimen installation 20
- Spool position 378
- Strain
  - shunt cal calculation 412
- Strain gage
  - reference data 411
- Strain gage calibration 405, 407
- Supervising the System 23
- System Administrator
  - application access 218
  - defining users 216
  - opening 216
- System calibration program 391

## T

---

- Technical assistance 27
- Telephone number 27
- Telex number 27
- Temperature controllers 175, 194
- Temposonics interface 95
- Tension
  - Extensometer calibration 276
  - force calibration 307
  - IVDT calibration 245
- TestStar
  - directory path 162, 186
  - installation procedure 33
- The 81, 92, 106, 138
- This 9, 212, 229, 238
- TIORAM boards 67
- transducer 148
- Troubleshooting 402
- Tuning
  - adjusting the servovalve 370
  - inner loop (servovalve) 370

## U

---

- Username
  - defining 217

## V

---

- Valve balance
  - adjustment procedure 383

Valve clamp 59  
Valve driver  
  forward loop filter kit 92  
  inner loop kit 84  
  specifications 361

## W

---

Warning symbol 26  
Window  
  Login 205

## Z

---

Zero  
  calibrating force zero 275  
  calibrating LVDT zero 244  
  calibrating strain zero 306

